

Features

- For E-GSM applications
- Usable bandwidth 35 MHz
- High attenuation
- No impedance matching required for operation at 50 Ω
- Single-ended operation
- Ceramic Surface Mount Package (SMP)
- Hermetic
- RoHS compliant (2002/95/EC), Pb-free 

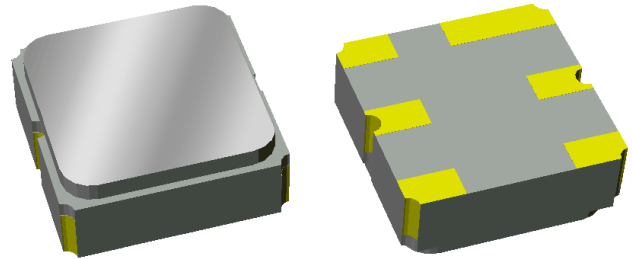

Package

Surface Mount 3.00 x 3.00 x 1.22 mm

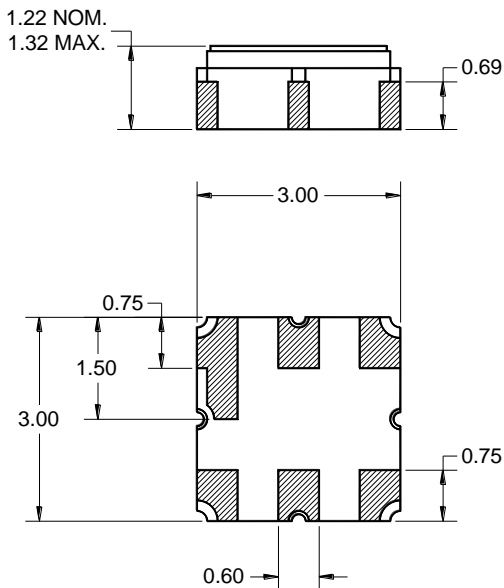

Dimensions shown are nominal in millimeters
All tolerances are ± 0.15 mm except overall
length and width ± 0.10 mm

Body: Al_2O_3 ceramic
Lid: Kovar, Ni plated
Terminations: Au plating 0.5 - 1.0 μ m,
over a 2 - 6 μ m Ni plating

Pin Configuration

Bottom View

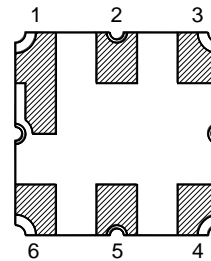

Pin No.	Description
2	Input
5	Output
1,3,4,6	Case ground

Electrical Specifications ⁽¹⁾

Operating Temperature Range: ⁽²⁾ -10 to +80 °C

Parameter ⁽³⁾	Minimum	Typical	Maximum	Unit
Center Frequency	-	942.5	-	MHz
Maximum Insertion Loss 925 - 960 MHz	-	2.50	3.75	dB
Absolute Attenuation				
0.3 - 800 MHz	48	57	-	dB
800 - 880 MHz	40	56	-	dB
880 - 905 MHz	35	40	-	dB
905 - 915 MHz	25	35	-	dB
980 - 1005 MHz	23	26	-	dB
1005 - 1025 MHz	30	35	-	dB
1025 - 1760 MHz	37	45	-	dB
1760 - 2500 MHz	27	40	-	dB
Amplitude Variation 925 - 960 MHz	-	1.1	2.5	dB p-p
Input/Output VSWR 925 - 960 MHz	-	2:1	2.3:1	-
Source Impedance ⁽⁴⁾	-	50	-	Ω
Load Impedance ⁽⁴⁾	-	50	-	Ω

Notes:

1. All specifications are based on the test circuit shown below
2. In production, devices will be tested at room temperature to a guardbanded specification to ensure electrical compliance over temperature
3. Electrical margin has been built into the design to account for the variations due to temperature drift and manufacturing tolerances
4. This is the optimum impedance in order to achieve the performance shown

Test Circuit:

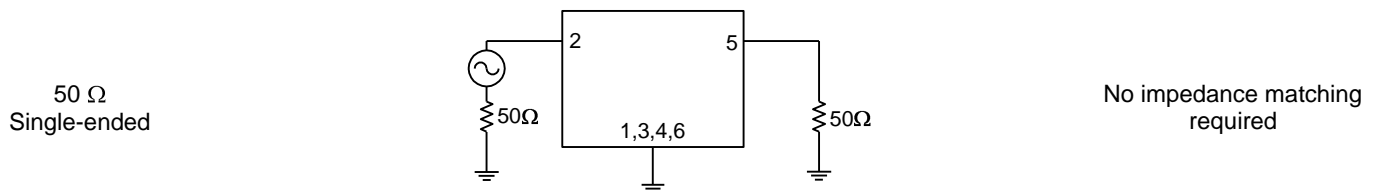

Typical Performance (at +25°C)

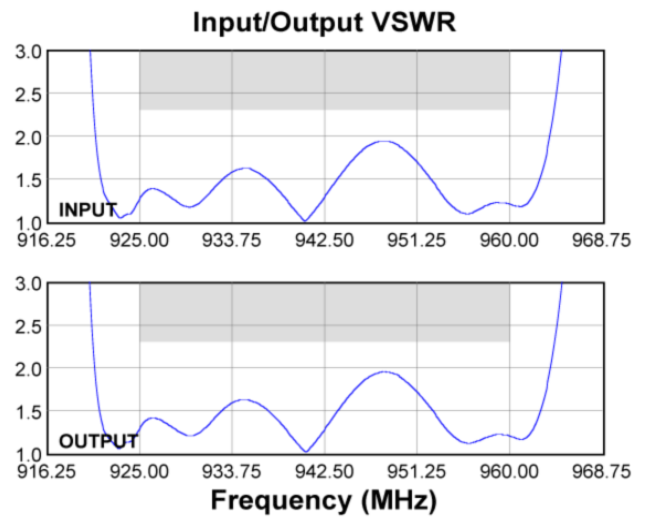
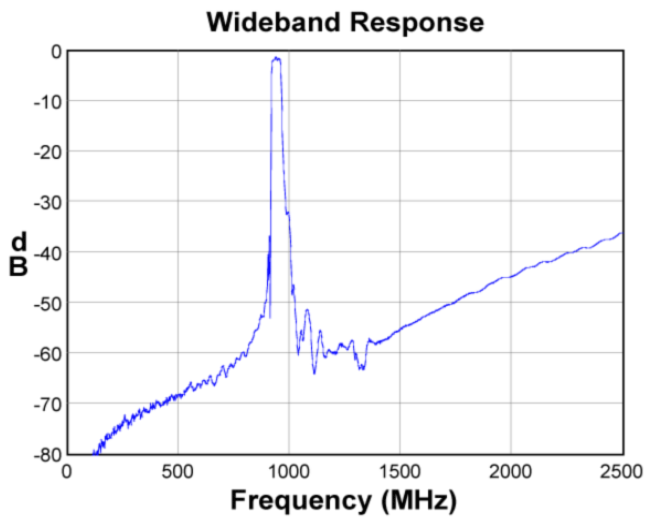
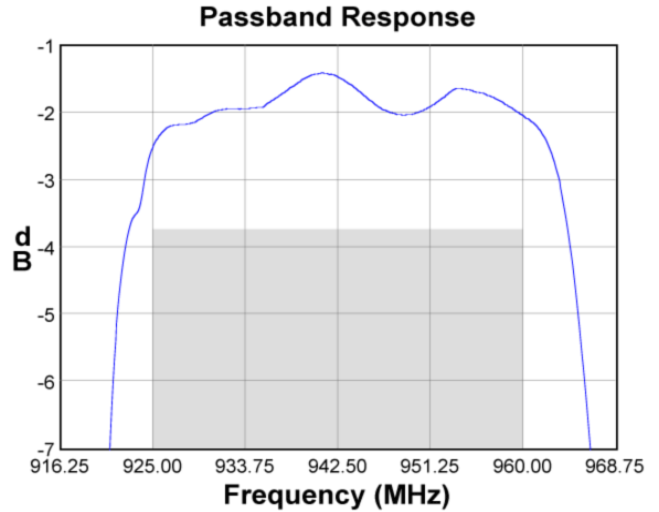
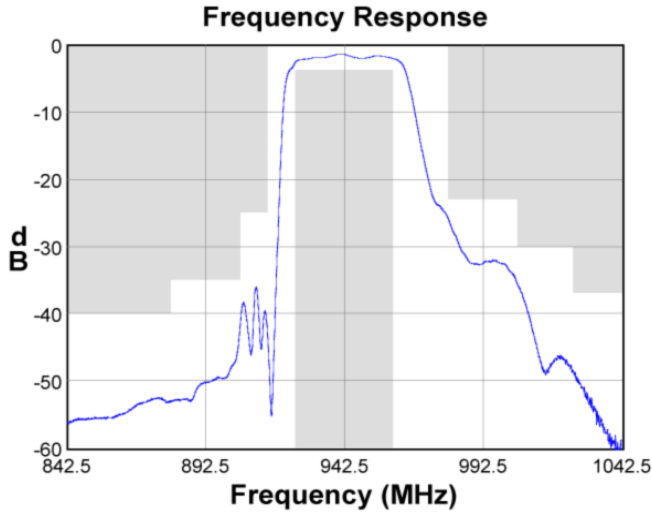

Input Smith Chart

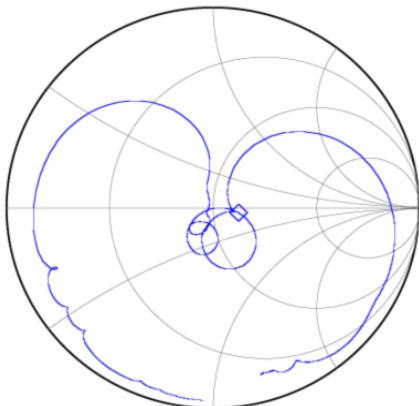

Output Smith Chart

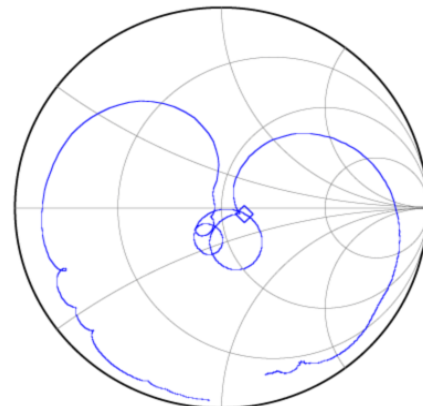

Matching Schematics

50 Ω
Single-ended

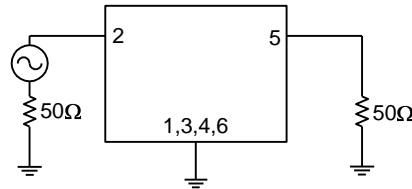

No impedance matching required

Marking

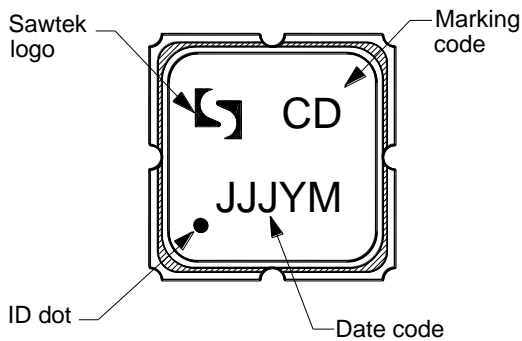

The date code consists of: JJJ = Julian day,
Y = last digit of year, M = manufacturing site code

PCB Footprint

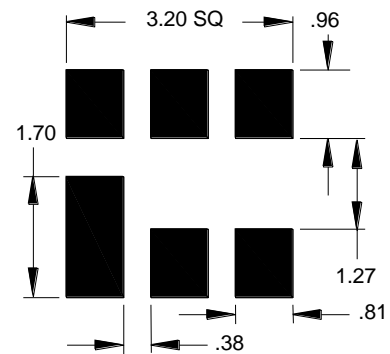

This footprint represents a recommendation only
Dimensions shown are nominal in millimeters

Tape and Reel

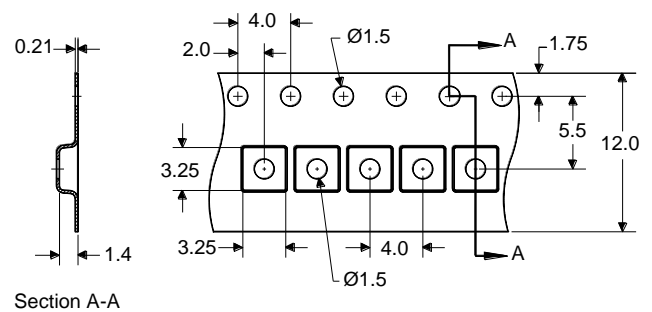
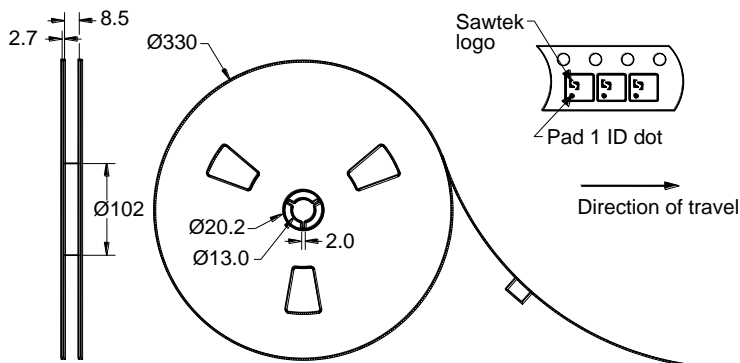

Dimensions shown are nominal in millimeters
Packaging quantity: 5000 units/reel

Maximum Ratings

Parameter	Symbol	Minimum	Maximum	Unit
Operating Temperature Range	T	-10	+80	°C
Storage Temperature Range	T _{stg}	-40	+85	°C
Input Power ⁽⁵⁾ (at 942.5 MHz, CW signal)	P _{in}	-	+11	dBm

Note:

- 5. Represents the maximum allowable power level without electrical degradation equivalent to duration of 10,000 hours at +55C

Important Notes

Warnings

- Electrostatic Sensitive Device (ESD) 
- Avoid ultrasonic exposure

RoHS Compliance

- This product complies with EU directive 2002/95/EC (RoHS) 

Solderability

- Compatible with JEDEC J-STD-020C **Pb-free** process, **260°C** peak reflow temperature ([see soldering profile](#))

Links to Additional Technical Information

[PCB Layout Tips](#)

[Qualification Flowchart](#)

[Soldering Profile](#)

[S-Parameters](#)

[RoHS Information](#)

[Other Technical Information](#)

TriQuint's liability is limited only to the Surface Acoustic Wave (SAW) component(s) described in this data sheet. TriQuint does not accept any liability for applications, processes, circuits or assemblies, which are implemented using any TriQuint component described in this data sheet.

Contact Information

TriQuint 
SEMICONDUCTOR
PO Box 609501
Orlando, FL 32860-9501
USA

Phone: +1 (407) 886-8860
Fax: +1 (407) 886-7061
Email: info-product@tqs.com
Web: www.triquint.com

Or contact one of our worldwide
Network of [sales offices](#),
[Representatives or distributors](#)