

NCP4371

Product Preview

Qualcomm Quick Charge™ 3.0 HVDCP Controller

NCP4371 is a USB secondary side fast-charging controller, supporting Qualcomm Quick Charge 3.0 (QC 3.0) High Voltage Dedicated Charging Port (HVDCP) Class A and Class B specification. NCP4371 allows for selection of the output voltage of an AC-DC USB adapter based on commands from the Portable Device (PD) being powered. Selecting a higher charging voltage will reduce the charging current for a given power level resulting in reduced IR drops and increased system efficiency. Another advantage of QC3.0 is a decreased battery charging time and a reduced PD system cost thanks to the ability to select an optimum charging voltage. This eliminates the need for costly DC-DC converters within the PD. The USB-bus voltage can be controlled in discreet steps from 3.6 V up to 20 V. The output current is limited not to exceed maximum allowable power level.

The NCP4371 resides at the secondary (isolated) side of the adapter. It includes voltage and current feedback regulation eliminating the need for a shunt regulator such as TL431.

The NCP4371 provides charging current limits down to $V_{BUS} = 2.2$ V protecting the portable device from excessive currents in case of a soft short-circuit condition.

The NCP4371 integrates a safe-discharge circuitry to quickly and reliably discharge output capacitors in case the USB cable is unplugged or connected to a 5 V only USB port.

Features

- Supports Qualcomm Quick Charge 3.0 HVDCP Class A/B
 - Output Voltage Can be Configured in Discreet Steps from
 - ◆ Class A: 3.6 V up to 12 V
 - ◆ Class B: 3.6 V up to 20 V
 - Compatible with USB Battery Charging Specification Revision 1.2 (USB BC1.2)
 - Constant Voltage and Constant Current Regulation
 - Soft Short-Circuit Current Limitation Down to $V_{BUS} = 2.2$ V
 - Removes a Need for the Secondary Side Shunt Regulator such as TL431
 - Output Capacitor Safe-Discharge Circuitry at Cable Unplug
 - Fast Dynamic Response
 - Built-in Power Limiting Function
 - Low Supply Current
 - Wide Operating Input Voltage Range: 2.2 V to 28 V
 - This is Pb-free Device
- #### Typical Applications
- Fast Charging AC/DC Adapters for Smart Phones, Tablets and Other Portable Devices

This document contains information on a product under development. ON Semiconductor reserves the right to change or discontinue this product without notice.



ON Semiconductor®

www.onsemi.com



SOIC-8
D SUFFIX
CASE 751

MARKING DIAGRAM

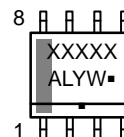

XXXXX = Specific Device Code
A = Assembly Location
L = Wafer Lot
Y = Year
W = Work Week
▪ = Pb-Free Package

PIN CONNECTIONS

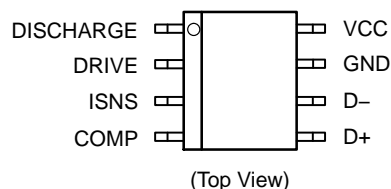

(Top View)

ORDERING INFORMATION

See detailed ordering, marking and shipping information in the package dimensions section on page 13 of this data sheet.

NCP4371

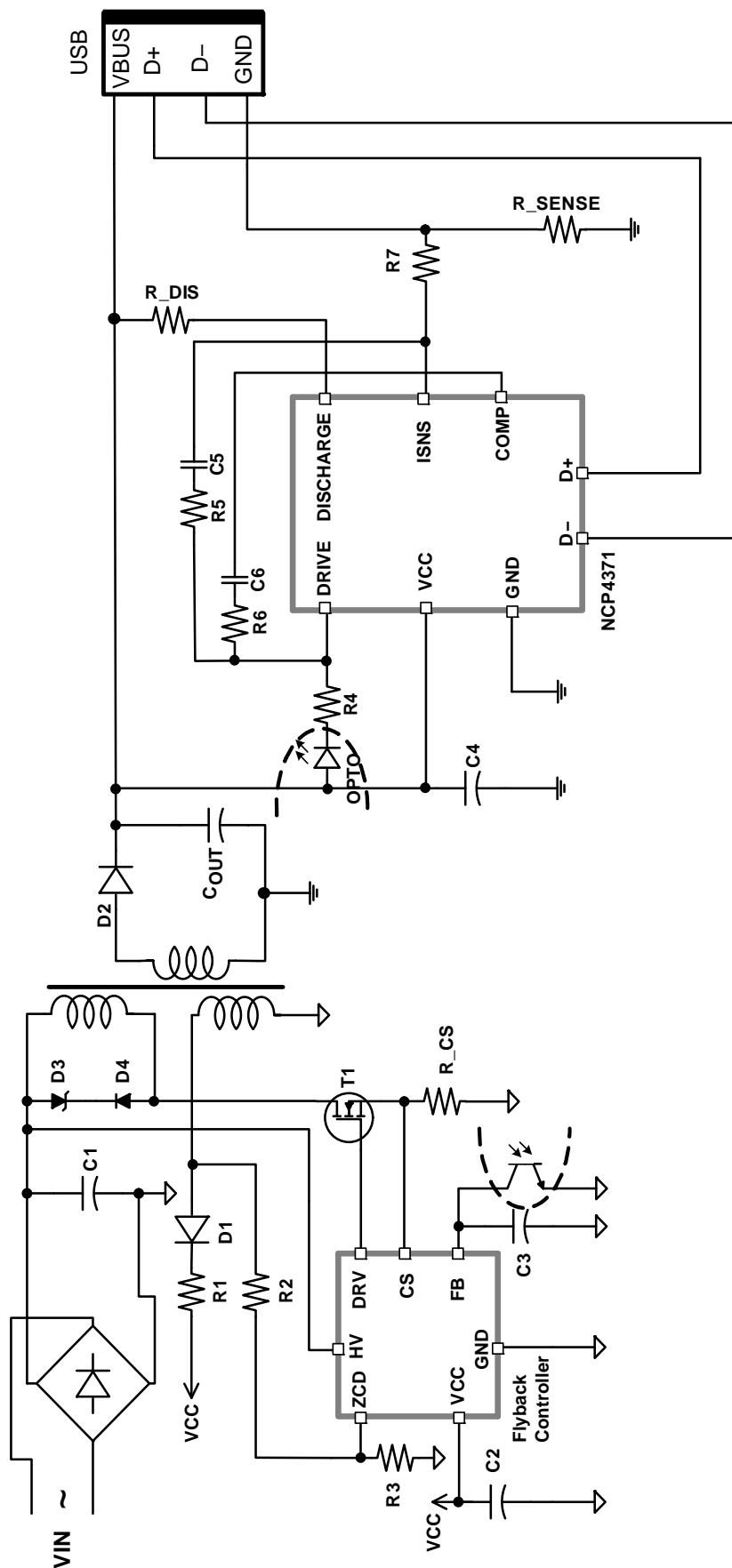

Figure 1. Typical Application Schematic

NCP4371

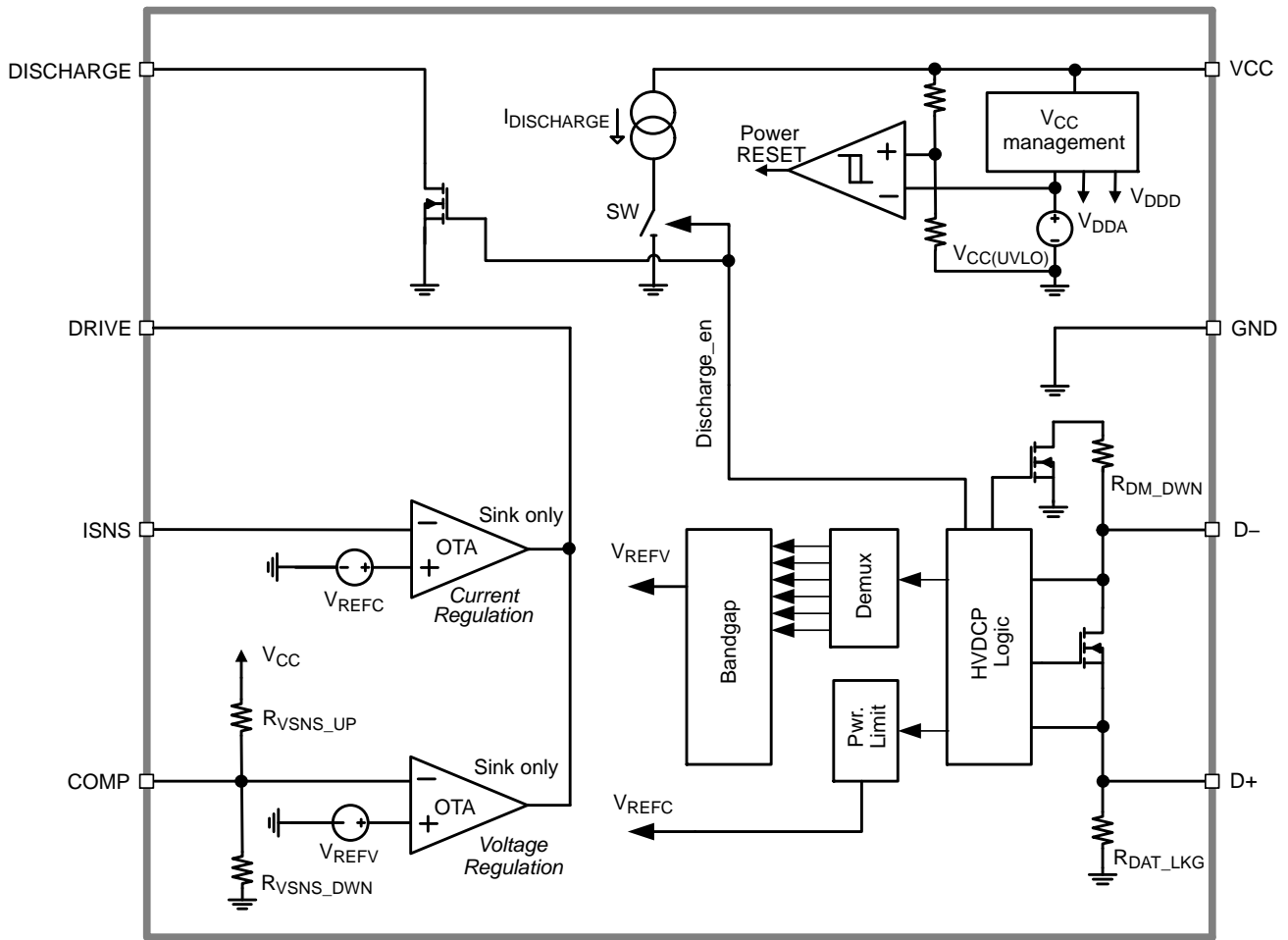

Figure 2. Simplified Block Diagram

Table 1. PIN FUNCTION DESCRIPTION

Pin No.	Pin Name	Description
1	DISCHARGE	This output is used to safely discharge V_{BUS} output capacitors when an unplug event is detected
2	DRIVE	Output of current sinking OTA amplifier or amplifiers driving feedback optocoupler's LED. Connect here compensation network (networks) as well.
3	ISNS	Current sensing input for output current regulation, connect it to shunt resistor in ground branch.
4	COMP	Compensation pin of output voltage regulation, connected to a feedback compensation network.
5	D+	USB D+ Data Line Input
6	D-	USB D- Data Line Input
7	GND	Ground
8	VCC	Supply voltage pin

NCP4371

Table 2. MAXIMUM RATINGS

Ratings	Symbol	Value	Unit
Supply Voltage	V_{CC}	-0.3 to 28.0	V
DISCHARGE, DRIVE Input Voltage	$V_{DISCHARGE}, V_{DRIVE}$	-0.3 to V_{CC}	V
D+, D-, COMP, ISNS Input Voltage	$V_{D+}, V_{D-}, V_{COMP}, V_{ISNS}$	-0.3 to 5.5	V
DISCHARGE Current	$I_{DISCHARGE}$	500	mA
DRIVE Sink Current	I_{DRIVE}	5	mA
Junction to Air Thermal Resistance, SOIC8	$R_{\theta J-A, SOIC8}$	160	°C/W
Maximum Junction Temperature	T_{JMAX}	125	°C
Storage Temperature	T_{STG}	-60 to 150	°C
ESD Capability, Human Body Model (Note 1)	ESD_{HBM}	4000	V
ESD Capability, Machine Model (Note 1)	ESD_{MM}	200	V

Stresses exceeding those listed in the Maximum Ratings table may damage the device. If any of these limits are exceeded, device functionality should not be assumed, damage may occur and reliability may be affected.

1. Refer to ELECTRICAL CHARACTERISTICS and APPLICATION INFORMATION for Safe Operating Area.

2. This device series incorporates ESD protection and is tested by the following methods:

ESD Human Body Model tested per AEC-Q100-002 (EIA/JESD22-A114)

ESD Machine Model tested per AEC-Q100-003 (EIA/JESD22-A115)

Latchup Current Maximum Rating: ≤ 150 mA per JEDEC standard: JESD78

3. For information, please refer to our Soldering and Mounting Techniques Reference Manual, SOLDERRM/D

Table 3. ELECTRICAL CHARACTERISTICS

-40°C $\leq T_J \leq 125$ °C; $V_{CC} = 5$ V; unless otherwise noted. Typical values are at $T_J = +25$ °C.

Parameter	Test Conditions	Symbol	Min	Typ	Max	Unit
SUPPLY						
Minimum Operating Input Voltage	V_{CC} voltage at which current limiting OTA is enabled	$V_{CC(min)}$	-	-	2.2	V
V_{CC} HVDCP Logic Enable	V_{CC} increasing level at which the HVDCP commands are accepted	$V_{CC(ON)}$	3.0	3.2	3.4	V
V_{CC} HVDCP Logic Disable	V_{CC} decreasing level at which the HVDCP commands are stopped to be accepted	$V_{CC(OFF)}$	2.8	3.0	3.3	V
Quiescent Current		I_{CC}			300	μ A
VOLTAGE CONTROL LOOP OTA						
Transconductance	Sink current only	g_{mv}	-	1	-	S
Voltage Control Reference Voltage	Nominal $V_{BUS}=5$ V	V_{REFV}	1.21	1.25	1.29	V
Sink Current Capability		I_{SINKV}	2.5			mA
Output Voltage Sense Divider Resistor, Pull-Up		R_{VSNS_UP}		66		k Ω
Output Voltage Sense Divider Resistor, Pull-Down		R_{VSNS_DWN}		24		k Ω
CURRENT CONTROL LOOP OTA						
Transconductance	Sink current only	g_{mc}	-	3	-	S
Current Control Reference Voltage	Current limit A reference set-point	$V_{REFC(A)}$	10	14	18	mV
	Current limit B reference set-point	$V_{REFC(B)}$	12	17	21	
	Current limit C reference set-point	$V_{REFC(C)}$	18	22	26	
	Current limit D reference set-point	$V_{REFC(D)}$	24	28	32	
	Current limit E reference set-point	$V_{REFC(E)}$	29	33	37	
	Current limit F reference set-point	$V_{REFC(F)}$	34	38	42	
	Current limit G reference set-point	$V_{REFC(G)}$	40	44	48	
	Current limit H reference set-point	$V_{REFC(H)}$	53	57	60	
Sink Current Capability		I_{SINKC}	2.5			mA
HVDCP						
Output Voltage Selection Reference		V_{SEL_REF}	1.8	2	2.2	V

NCP4371

Table 3. ELECTRICAL CHARACTERISTICS

-40°C ≤ T_J ≤ 125°C; V_{CC} = 5 V; unless otherwise noted. Typical values are at T_J = +25°C.

Parameter	Test Conditions	Symbol	Min	Typ	Max	Unit
HVDCP						
Data Detect Voltage		V _{DAT_REF}	0.25	0.325	0.4	V
Data Line Leakage Resistance		R _{DAT_LKG}	300	-	1500	kΩ
D- Pull-Down Resistance		R _{DM_DWN}	14.25	19.53	24.8	kΩ
D+ to D- Resistance During DCP Mode		R _{DCP_DAT}			40	Ω
D+ High Glitch Filter Time		T _{GLITCH_BC_DONE}	1		1.5	sec
D- Low Glitch Filter Time		T _{GLITCH_DM_LOW}	1			ms
Output Voltage Glitch Filter Time of HVDCP		T _{GLITCH_V_CHANGE}	20	40	60	ms
Glitch Filter For D+/- Pull-Up or Down Time in HVDCP		T _{GLITCH_CONT_CHANGE}	100		200	μs
OUTPUT CAPACITOR DISCHARGER						
Discharge Comparator OFF Voltage	V _{BUS_REF} = 5 V, V _{DIS(OFF)} sensed at VCC pin	V _{DIS(OFF)}	5.4	5.6	5.8	mV
VCC Discharge Current	Discharge current of the internal current sink at the VCC pin	I _{DIS(VCC)}			85	mA
DISCHARGE Pin Maximum Sink Current	Maximum sink current of the DISCHARGE pin Minimum recommended external discharge resistor value connected from V _{BUS} to DISCHARGE pin is R _{DIS} ≥ 100 Ω	I _{DIS(EXT)}			200	mA

Product parametric performance is indicated in the Electrical Characteristics for the listed test conditions, unless otherwise noted. Product performance may not be indicated by the Electrical Characteristics if operated under different conditions.

NCP4371

TYPICAL CHARACTERISTICS

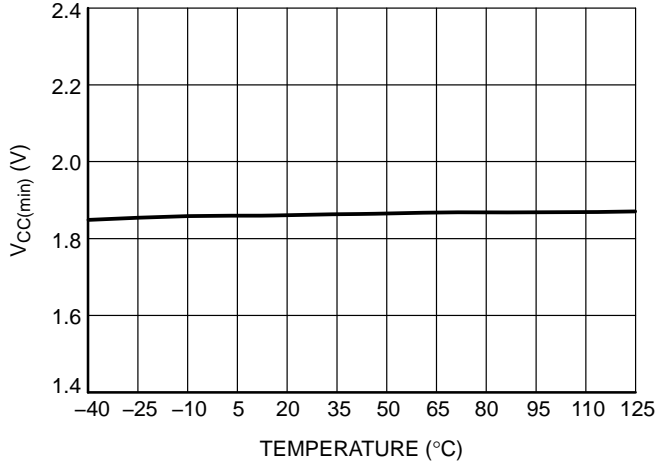

Figure 3. V_{CC} Minimum Operating Input Voltage, $V_{CC(min)}$

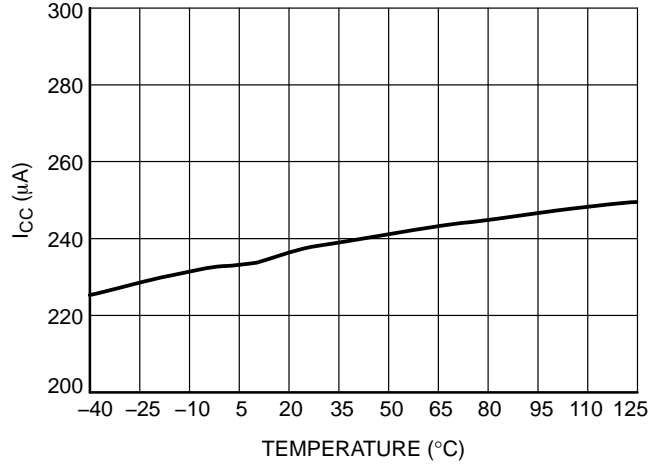

Figure 4. Quiescent Current, I_{CC}

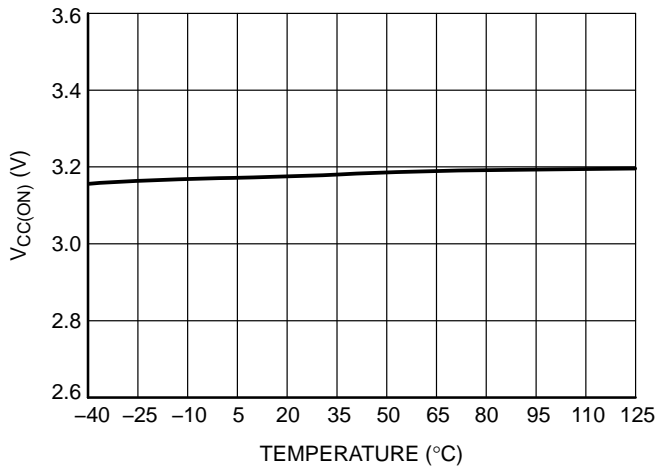

Figure 5. V_{CC} HVDCP Logic Enable, $V_{CC(ON)}$

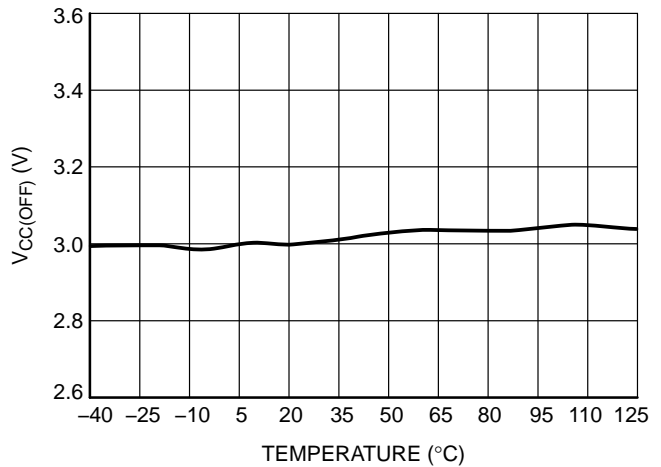

Figure 6. V_{CC} HVDCP Logic Disable, $V_{CC(OFF)}$

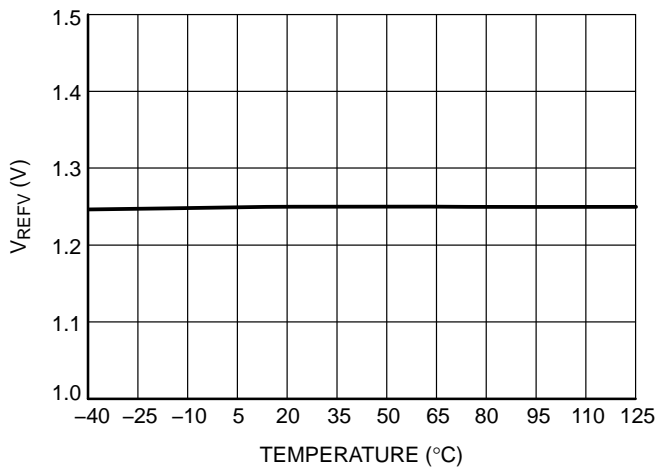

Figure 7. Voltage Control Reference Voltage, V_{REFV}

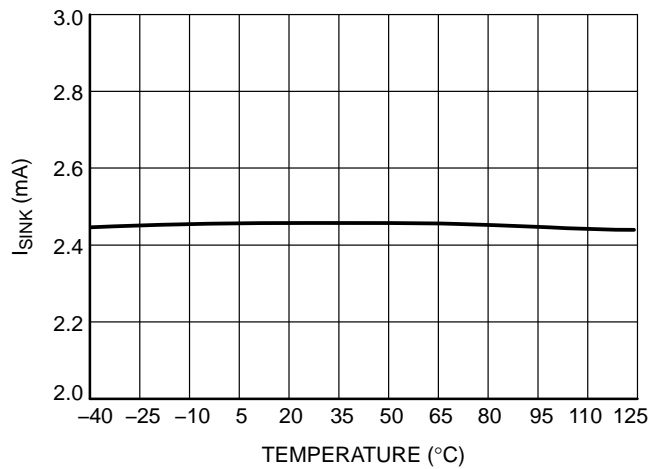

Figure 8. Voltage Control OTA Sink Current Capability, I_{SINKV}

NCP4371

TYPICAL CHARACTERISTICS

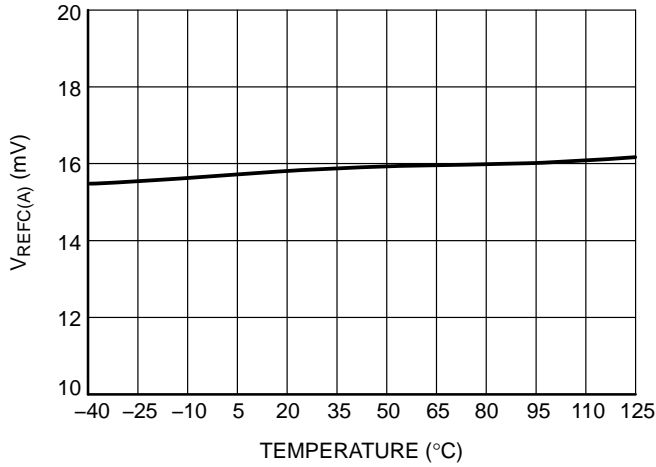

Figure 9. Current Control Reference Voltage, $V_{REFC(A)}$

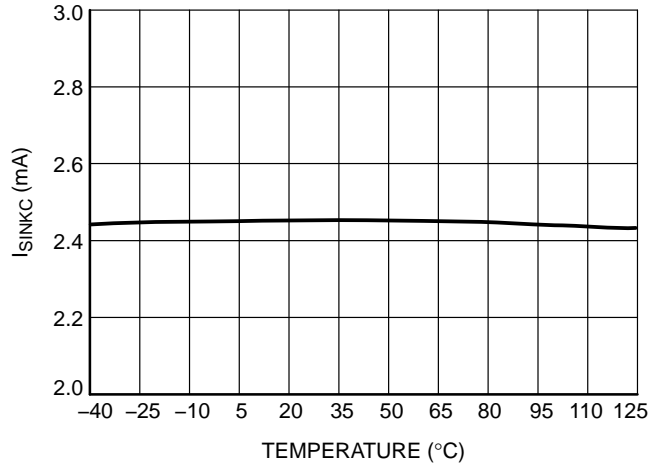

Figure 10. Voltage Control OTA Sink Current Capability, I_{SINKC}

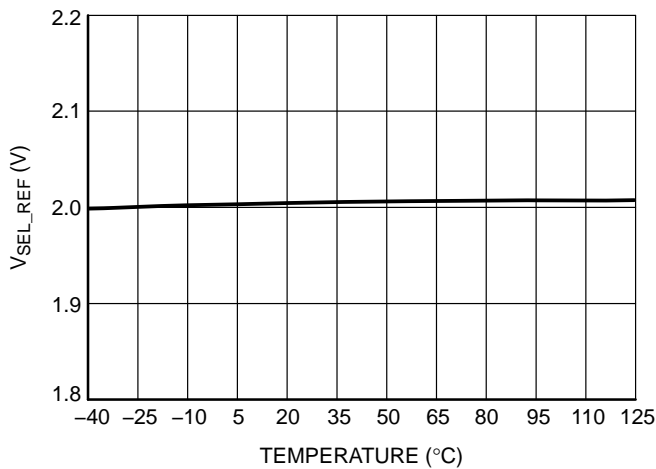

Figure 11. Output Voltage Selection Reference, V_{SEL_REF}

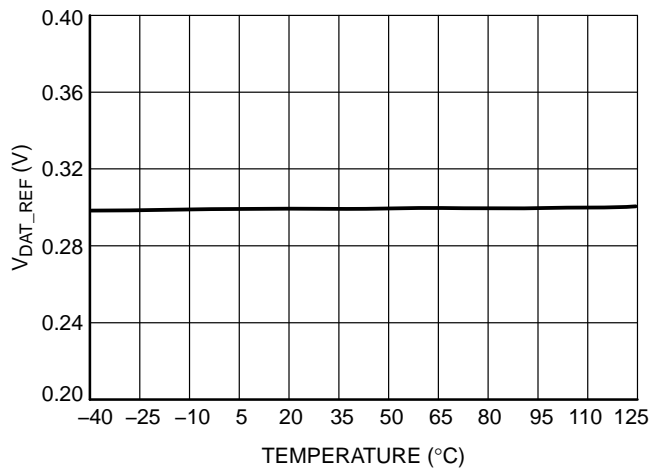

Figure 12. Data Detect Voltage, V_{DAT_REF}

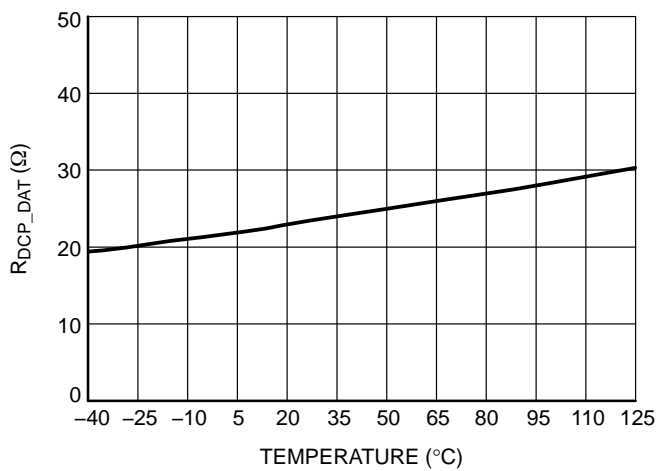

Figure 13. D+ to D- Resistance During DCP Mode, R_{DCP_DAT}

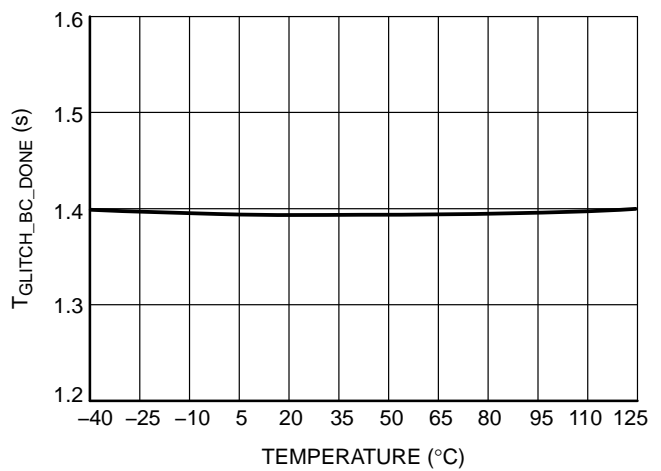

Figure 14. D+ High Glitch Filter Time, $T_{GLITCH_BC_DONE}$

TYPICAL CHARACTERISTICS

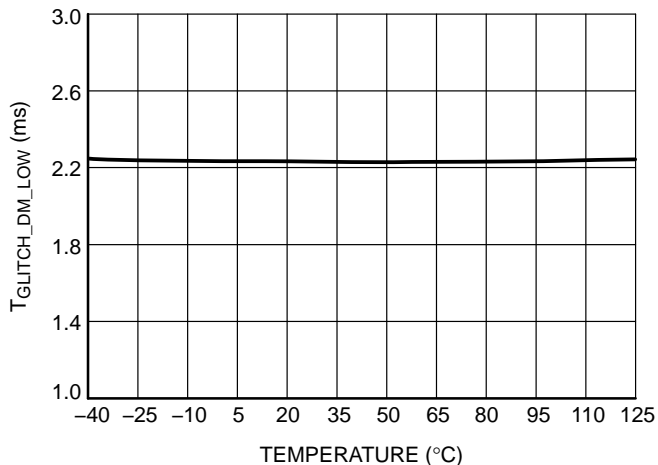

Figure 15. D- Low Glitch Filter, T_{GLITCH_DM_LOW}

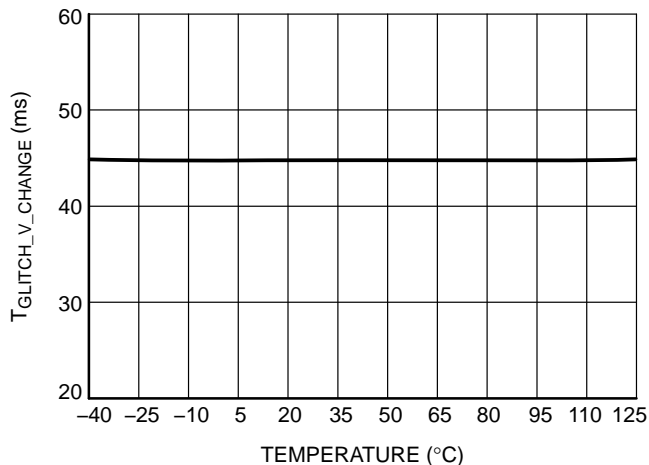

Figure 16. Output Voltage Glitch Filter Time of HVDCP, T_{GLITCH_V_CHANGE}

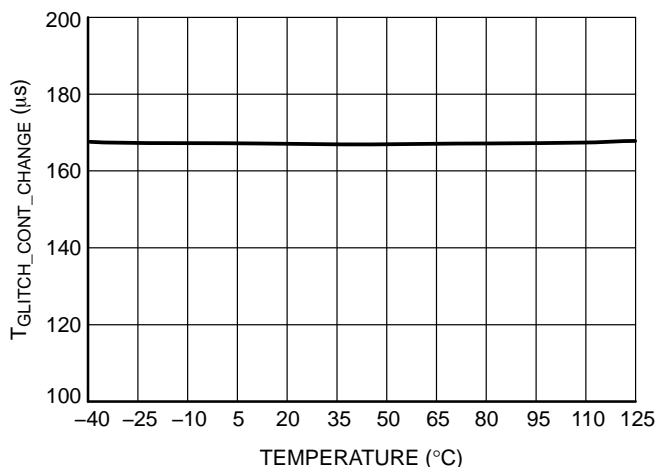

Figure 17. Glitch Filter For D+/- Pull-Up or Down Time in HVDCP, T_{GLITCH_CONT_CHANGE}

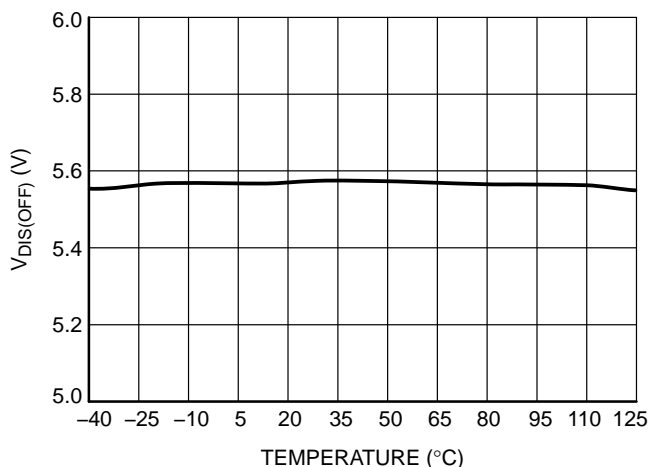

Figure 18. Discharge Comparator OFF Voltage, V_{DIS(OFF)}

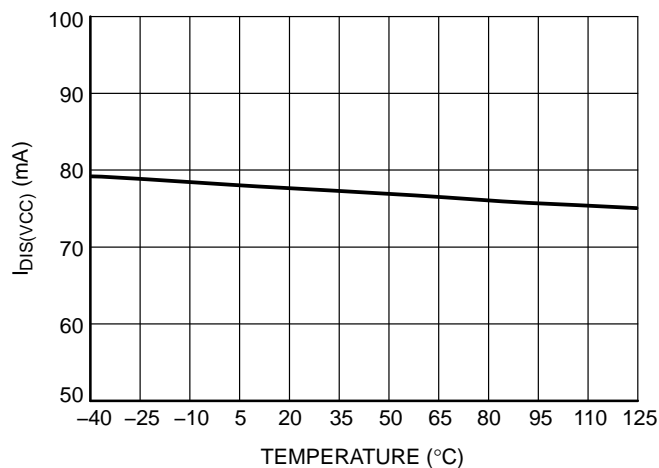

Figure 19. VCC Discharge Current, I_{DIS(VCC)}

APPLICATION INFORMATION

The NCP4371 is designed to operate as an output voltage and current controller for USB chargers, which resides on the secondary side of the off-line adapter. It enables to accommodate the output voltage based on the request from the portable device in order to optimize the battery charge time. The NCP4371 is compatible with Qualcomm Quick Charge 3.0 HVDCP specification. The output voltage can be increased or decreased in discrete steps. The output current is limited not to exceed the maximum power limit for given output voltage level. The internal discharge switch discharges the output capacitors to a safe voltage level in a case of the cable unplug.

Voltage Regulation

The Voltage Regulation Path eliminates a need for a voltage shunt regulator at the secondary side of the off-line supply. The voltage on VCC pin is divided by internal resistor divider (R_{VSNS_UP} , R_{VSNS_DWN}) and compared with the internal precise voltage reference V_{REFV} . The voltage difference is amplified by g_{mV} of the transconductance amplifier. The amplifier output current is connected to the DRIVE pin. This DRIVE pin drives regulation optocoupler that provides regulation of primary side. The internal voltage reference V_{REFV} is adjustable based on the command from the Portable Device compatible with Qualcomm Quick Charge specification. The voltage control loop compensation network shall be connected between DRIVE and COMP pins.

Current Regulation

The output current is sensed by the shunt resistor R_{SENSE} in series with the load. Voltage drop on R_{SENSE} is compared with internal precise voltage reference V_{REFC} at ISNS transconductance amplifier input. Voltage difference is amplified by g_{mC} to output current of amplifier, connected to the DRIVE pin.

HVDCP Mode

After power-up pins D+ and D- of NCP4371 are shorted with impedance R_{DCP_DAT} and internal reference voltage V_{REFV} is set to V_{BUS} voltage 5V. The device is in a BC1.2 compatible mode. If a portable device compatible with the Qualcomm Quick Charge specification is connected a negotiation between HVDCP and PD is executed. Once the negotiation is successful the NCP4371 opens D+ and D- short connection and D- is pulled down with a R_{DM_DWN} . The NCP4371 enters HVDCP mode. It monitors D+ and D- inputs. Based on the specified control patterns the internal voltage reference value V_{REFV} is adjusted in order to increase or decrease output voltage to the required value. The NCP4371 is available in Class A and Class B version. Class A allows to change the output voltage up to $V_{BUS} = 12$ V. Class B allows output voltage up to 20 V. If

the unplug event is detected the decoder circuitry turns-on an internal current sink, which discharges the output capacitors to a safe voltage level. If the NCP4371 is set to a Continuous mode it responds to the PD requests in a Single request mode. It does not support Group request mode.

Table 4. D+ AND D- OUTPUT VOLTAGE CODING

Portable Device		HVDCP Class A	HVDCP Class B
D+	D-	Adapter Voltage	Adapter Voltage
0.6 V	0.6 V	12 V	12 V
3.3 V	0.6 V	9 V	9 V
0.6 V	3.3 V	Continuous mode	Continuous mode
3.3 V	3.3 V	Previous voltage	20 V
0.6 V	GND	5 V	5V

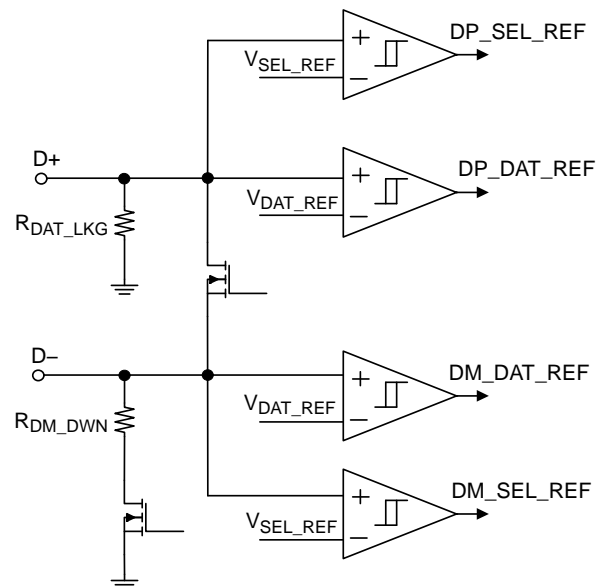

Figure 20. HVDCP D+ and D- Comparators

HVDCP Mode – Continuous Mode

The continuous mode of operation leverages the previously unused state in QC2.0. If the portable devices try and utilize this mode, it applies voltages on D+ and D- per Table 1. Assuming the HVDCP supports this mode of operation, it will glitch filter the request as it currently does, using $T_{GLITCH_V_CHANGE}$. Before the portable device can begin to increment or decrement the voltage, it must wait $T_{V_NEW_REQUEST_CONT}$ before pulling D+ and D- high or low. Once this time has finished, the portable device now attempts to increment or decrement the voltage. To increment, the portable device sends a pulse of width T_{ACTIVE} by pulling D+ to V_{DP_UP} and then must return D+ to V_{DP_SRC} for $T_{INACTIVE}$.

NCP4371

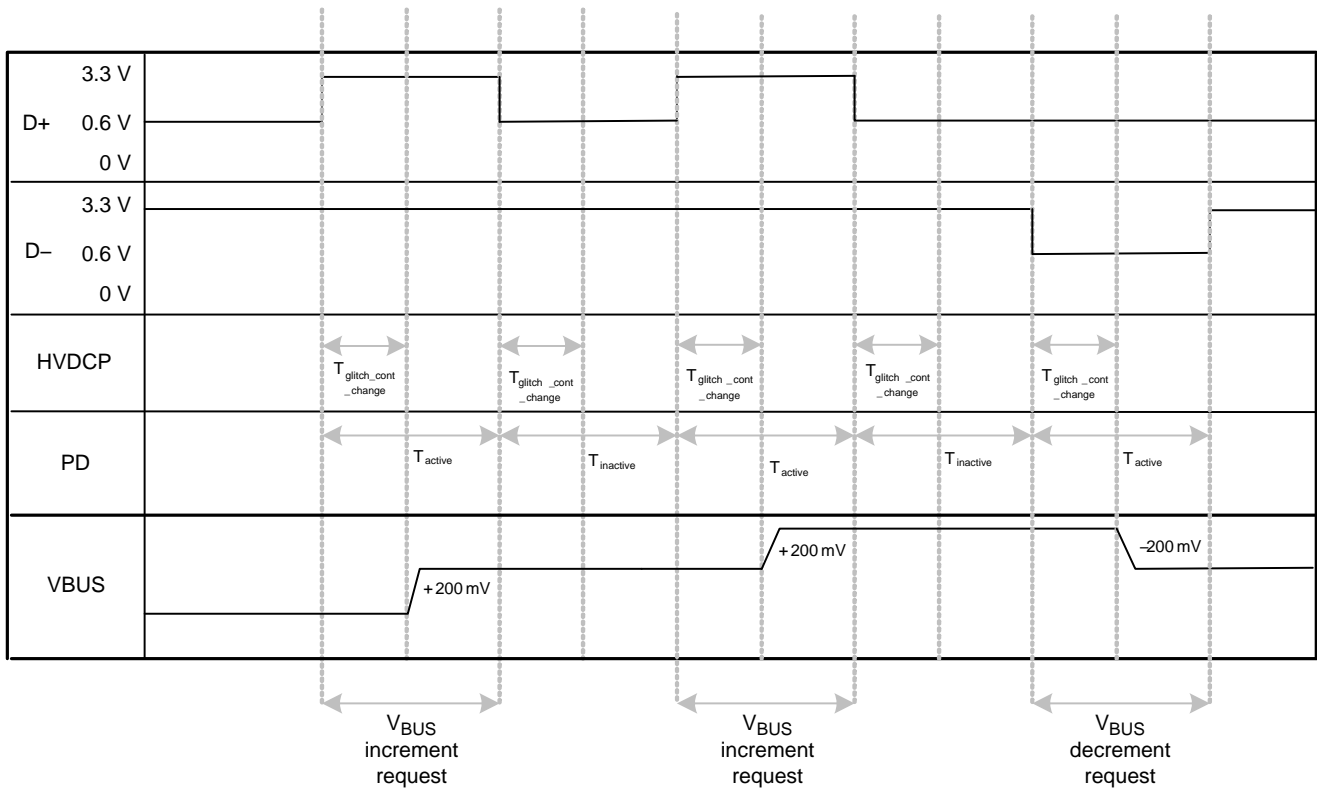

Figure 21. Continuous Mode of Operation Timing Diagram

The NCP4371 responds to the increment/decrement request in a single request mode, i.e. the output voltage is changed immediately with each request. For the single request, and HVDCP recognizes a rising edge on D+ for an increment, and falling edge on D- for a decrement, and

glitch filters this with $T_{\text{GLITCH_CONT_CHANGE}}$. After this period, it begins changing its output voltage by incrementing or decrementing in a 200 mV step. The output voltage is at its final value within $T_{\text{V_CONT_CHANGE_SINGLE}}$.

NCP4371

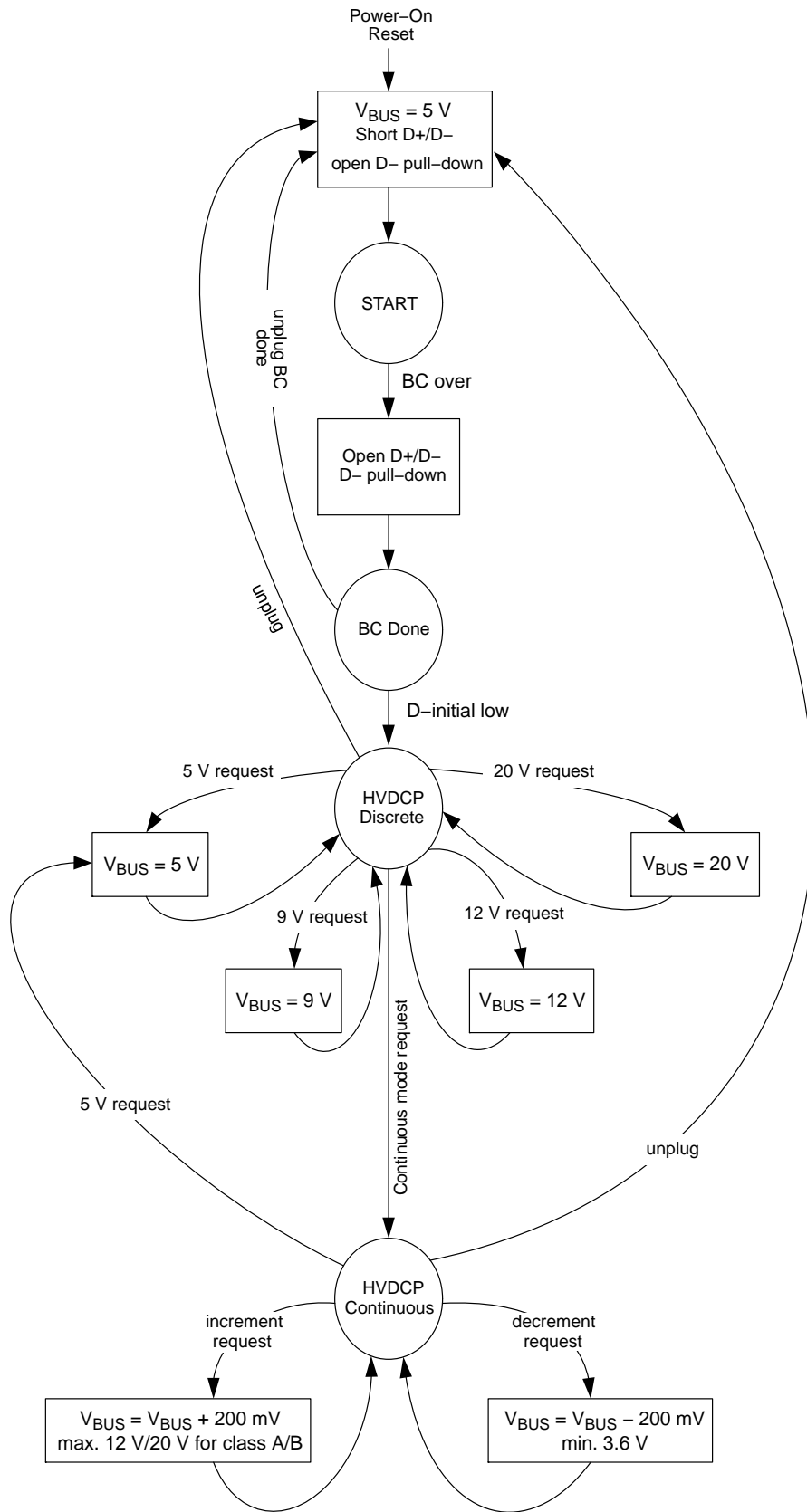

Figure 22. NCP4371 State Diagram

Power Limit

The protocol decoder and the power limit logic will limit maximum output current to keep regulation within recommended V_{out}/I_{out} operating range. The Power Limit block adjusts V_{REFC} voltage reference at the current regulation loop in order to limit the maximum output current.

The NCP4371 is designed to give a user a high degree of freedom to optimize maximum power and current limit profile of the target application. The user can scale both – maximum output power and maximum current limit independently.

The NCP4371 has two constant power curves defined – “Option A” for Class A only and “Option B” for either Class A or Class B. Power Option C shall be used for applications where constant power regulation is not required. If Power Option C is selected then power limiting curve is ignored. The applications based on Power Option C operate in “constant current regulation mode”.

In order to scale the power limit curve for the given power a selection of the current sense resistor has to be done. The relation between current sense resistor and output power limit is given by the curves in Figure 23.

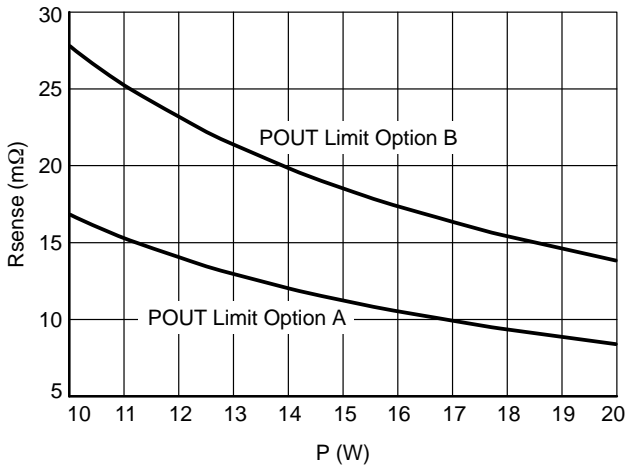

Figure 23. R_{SENSE} vs. P_{OUT} Limit Curve

The characteristics in the Figure 23 cover a range P_{OUT} = 10 – 20 W. For powers outside this interval following formula can be used for R_{SENSE} selection:

Option A (Class A only) : $R_{SENSE} = \frac{168}{P_{max}}$ [mΩ] (eq. 1)

Option B (Class A & B) : $R_{SENSE} = \frac{277}{P_{max}}$ [mΩ] (eq. 2)

Once the Power limit is defined by an R_{SENSE} selection the user needs to define a maximum output current limit. This current limit can be given by a connector or cable maximum current rating.

There are 5 current limit options available for Power Option A and 8 current limit options for Power Option B and C. Each power limit option corresponds to a particular Current Control Reference Voltage (V_{REFC}), which limits the maximum output current for the selected R_{SENSE} resistor. The user has to make a selection from current limit characteristics shown in Figure 24. Each power limit curve represents a unique device option (see Table Device Options).

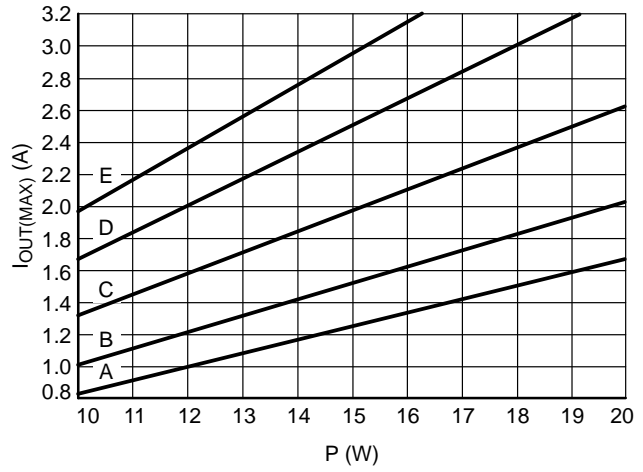

Power Option A Current Limit Selection

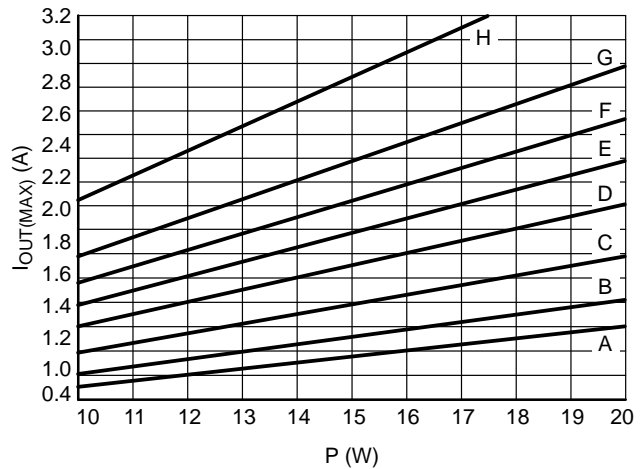

Power Option B Current Limit Selection

Figure 24. Current Limit Characteristics

NCP4371

Table 5. CURRENT LIMIT OPTION REFERENCE VOLTAGE

Current Limit Option	A	B	C	D	E	F	G	H
V _{REFC} [mV]	14	17	22	28	33	38	44	57

Soft Short–Circuit Protection

In case of a short–circuit at the USB cable end or the portable device USB receptacle it is desired to limit the short circuit current to prevent a portable device or cable from a damage. The NCP4371 offers an extended region of output current limiting down to V_{BUS} = 2.2 V. If the V_{BUS} falls below V_{CC(OFF)} then the HVDCP logic is disabled and D+/- pins are shorted. No further commands from the portable device are accepted. The only feature enabled is the output current limiting at the moment. The device stays in the current limiting mode until V_{CC} rises back above V_{CC(ON)} threshold. The device logic will resume its operation and goes to a default BC1.2 compatible mode. A new negotiation between the charger and portable device has to be carried out in order to enable HVDCP compatibility mode.

Discharge

If voltage level lower than actual V_{BUS} is requested by PD the discharge circuitry discharges the output capacitors to reach the new voltage level in a short time. As well, the discharge circuitry is activated if cable unplug event is detected. The NCP4371 features two discharge paths. By default, the discharge is done via built–in regulated current source at VCC pin. If the VCC pin discharge capability is not sufficient an external discharge resistor R_{DIS} has to be used. The discharge resistor is wired from a positive pole of the output capacitor to the DISCHARGE pin. The minimum recommended value of the discharge resistor R_{DIS} is 100 Ω. The DISCHARGE pin has an internal protection for a case the user wires the pin directly to V_{BUS}. If this condition is detected the discharge MOSFET at the pin is turned off. It is highly recommended to use an external discharge resistor always if Class B device is used. In case of Class A device and C_{OUT} < 1500 μF the DISCHARGE pin can be left disconnected.

Table 6. DEVICE OPTIONS

OPN # NCP4371__DR2G	Marking	QuickCharge Class A/B		Power Limit			Current Limit (mV)							
		A	B	A	B	C	A	B	C	D	E	F	G	H
		Class A	Class B	Class A	Class A&B	No Power Limit	14	17	22	28	33	38	44	57
NCP4371AACDR2G	4371AAC	X		X					X					
NCP4371AAEDR2G	4371AAE	X		X						X				
NCP4371AADDR2G	4371AAD	X		X						X				
NCP4371ACCDR2G	4371ACC	X				X			X					
NCP4371BBEDR2G	4371BBE		X		X						X			

ORDERING INFORMATION

Device	Marking	Package	Shipping†
NCP4371AACDR2G	4371AAC	SOIC–8 Pb–Free	2500 / Tape & Reel
NCP4371AAEDR2G	4371AAE		
NCP4371AADDR2G	4371AAD		
NCP4371ACCDR2G	4371ACC		
NCP4371BBEDR2G	4371BBE		

†For information on tape and reel specifications, including part orientation and tape sizes, please refer to our Tape and Reel Packaging Specifications Brochure, BRD8011/D.

NCP4371

PACKAGE DIMENSIONS

SOIC-8 NB
CASE 751-07
ISSUE AK

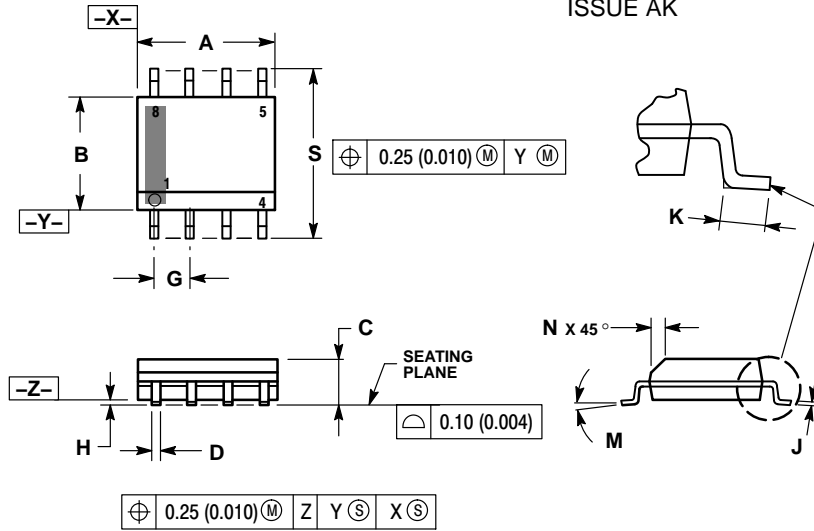

NOTES:

1. DIMENSIONING AND TOLERANCING PER ANSI Y14.5M, 1982.
2. CONTROLLING DIMENSION: MILLIMETER.
3. DIMENSION A AND B DO NOT INCLUDE MOLD PROTRUSION.
4. MAXIMUM MOLD PROTRUSION 0.15 (0.006) PER SIDE.
5. DIMENSION D DOES NOT INCLUDE DAMBAR PROTRUSION. ALLOWABLE DAMBAR PROTRUSION SHALL BE 0.127 (0.005) TOTAL IN EXCESS OF THE D DIMENSION AT MAXIMUM MATERIAL CONDITION.
6. 751-01 THRU 751-06 ARE OBSOLETE. NEW STANDARD IS 751-07.

DIM	MILLIMETERS		INCHES	
	MIN	MAX	MIN	MAX
A	4.80	5.00	0.189	0.197
B	3.80	4.00	0.150	0.157
C	1.35	1.75	0.053	0.069
D	0.33	0.51	0.013	0.020
G	1.27 BSC		0.050 BSC	
H	0.10	0.25	0.004	0.010
J	0.19	0.25	0.007	0.010
K	0.40	1.27	0.016	0.050
M	0°	8°	0°	8°
N	0.25	0.50	0.010	0.020
S	5.80	6.20	0.228	0.244

SOLDERING FOOTPRINT*

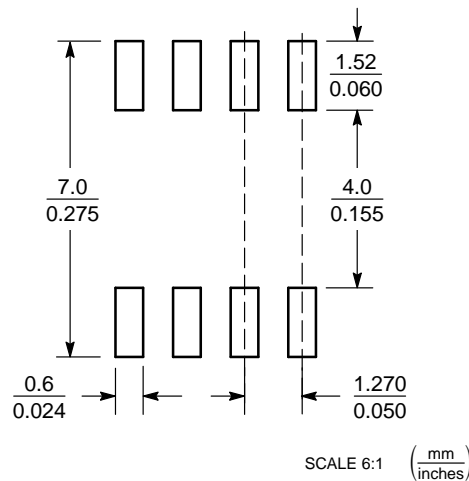

*For additional information on our Pb-Free strategy and soldering details, please download the ON Semiconductor Soldering and Mounting Techniques Reference Manual, SOLDERRM/D.

Qualcomm Quick Charge is a trademark of Qualcomm Incorporated.

ON Semiconductor and the are registered trademarks of Semiconductor Components Industries, LLC (SCILLC) or its subsidiaries in the United States and/or other countries. SCILLC owns the rights to a number of patents, trademarks, copyrights, trade secrets, and other intellectual property. A listing of SCILLC's product/patent coverage may be accessed at www.onsemi.com/site/pdf/Patent-Marking.pdf. SCILLC reserves the right to make changes without further notice to any products herein. SCILLC makes no warranty, representation or guarantee regarding the suitability of its products for any particular purpose, nor does SCILLC assume any liability arising out of the application or use of any product or circuit, and specifically disclaims any and all liability, including without limitation special, consequential or incidental damages. "Typical" parameters which may be provided in SCILLC data sheets and/or specifications can and do vary in different applications and actual performance may vary over time. All operating parameters, including "Typicals" must be validated for each customer application by customer's technical experts. SCILLC does not convey any license under its patent rights nor the rights of others. SCILLC products are not designed, intended, or authorized for use as components in systems intended for surgical implant into the body, or other applications intended to support or sustain life, or for any other application in which the failure of the SCILLC product could create a situation where personal injury or death may occur. Should Buyer purchase or use SCILLC products for any such unintended or unauthorized application, Buyer shall indemnify and hold SCILLC and its officers, employees, subsidiaries, affiliates, and distributors harmless against all claims, costs, damages, and expenses, and reasonable attorney fees arising out of, directly or indirectly, any claim of personal injury or death associated with such unintended or unauthorized use, even if such claim alleges that SCILLC was negligent regarding the design or manufacture of the part. SCILLC is an Equal Opportunity/Affirmative Action Employer. This literature is subject to all applicable copyright laws and is not for resale in any manner.

PUBLICATION ORDERING INFORMATION

LITERATURE FULFILLMENT:
Literature Distribution Center for ON Semiconductor
19521 E. 32nd Pkwy, Aurora, Colorado 80011 USA
Phone: 303-675-2175 or 800-344-3860 Toll Free USA/Canada
Fax: 303-675-2176 or 800-344-3867 Toll Free USA/Canada
Email: orderlit@onsemi.com

N. American Technical Support: 800-282-9855 Toll Free
USA/Canada
Europe, Middle East and Africa Technical Support:
Phone: 421 33 790 2910
Japan Customer Focus Center
Phone: 81-3-5817-1050

ON Semiconductor Website: www.onsemi.com
Order Literature: <http://www.onsemi.com/orderlit>

For additional information, please contact your local Sales Representative