

## GaAs MMIC DOUBLE-BALANCED MIXER, 4 - 8 GHz

### Typical Applications

The HMC129 is ideal for:

- Microwave & VSAT Radios
- Test Equipment
- Military EW, ECM, C<sup>3</sup>I
- Space Telecom

### Features

- Conversion Loss: 7 dB
- LO to RF and IF Isolation: 40 dB
- Input IP3: +17 dBm
- No DC Bias Required
- Die Size: 1.40 x 1.40 x 0.1 mm

### Functional Diagram

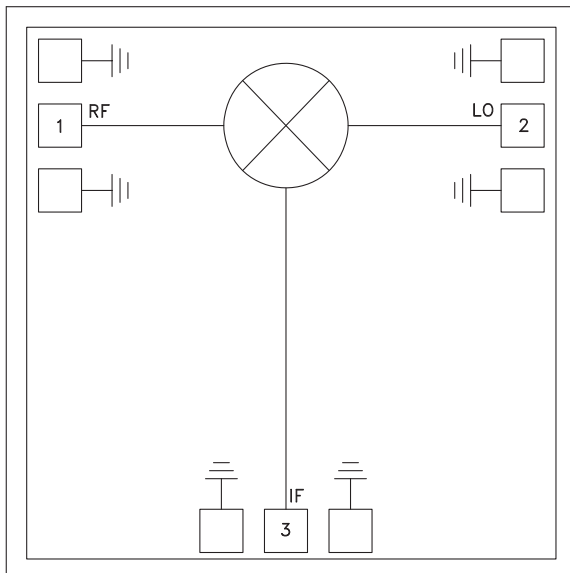

### General Description

The HMC129 chip is a miniature double-balanced mixer which can be used as an upconverter or downconverter in the 4 to 8 GHz band. The chip can be integrated directly into hybrid MICs without DC bias or external baluns to provide an extremely compact mixer. It is ideally suited for applications where small size, no DC bias, and consistent IC performance are required. This mixer can operate over a wide LO drive input of +9 to +15 dBm. It performs equally well as a Bi-Phase modulator or demodulator. See the HMC136 data sheet.

### Electrical Specifications, $T_A = +25^\circ\text{C}$ , LO Drive = +15 dBm\*

Parameter	Min.	Typ.	Max.	Units
Frequency Range, RF & LO	4 - 8			GHz
Frequency Range, IF	DC - 3			GHz
Conversion Loss		7	9	dB
Noise Figure (SSB)		7	9	dB
LO to RF Isolation	30	40		dB
LO to IF Isolation	35	42		dB
IP3 (Input)	13	17		dBm
IP2 (Input)	40	55		dBm
1 dB Gain Compression (Input)	6	10		dBm

\* Unless otherwise noted, all measurements performed as downconverter, IF = 100 MHz

**GaAs MMIC DOUBLE-BALANCED  
MIXER, 4 - 8 GHz**

**Conversion Gain vs. Temperature**  
**LO = +15 dBm**

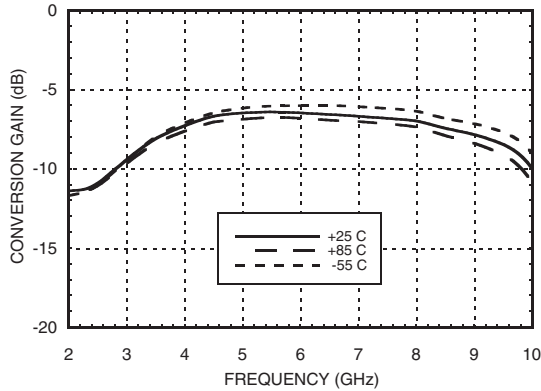

**Isolation @ LO = +15 dBm**

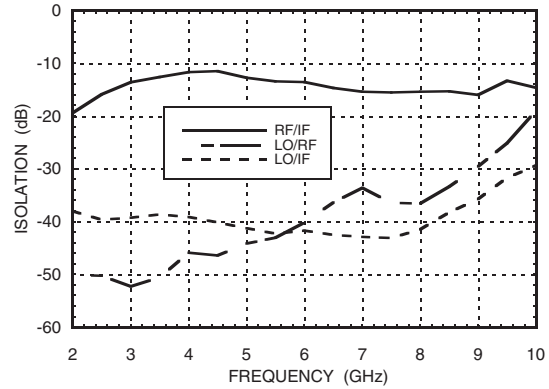

**Conversion Gain vs. LO Drive**

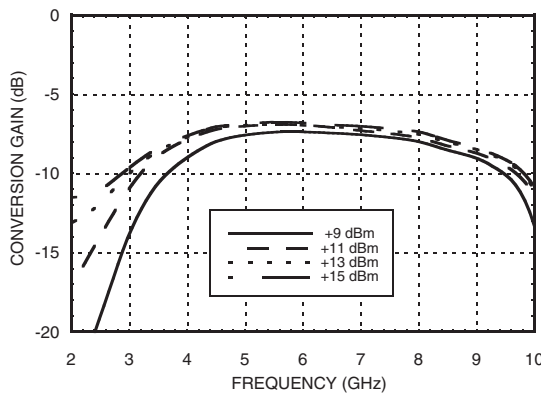

**Return Loss @ LO = +15 dBm**

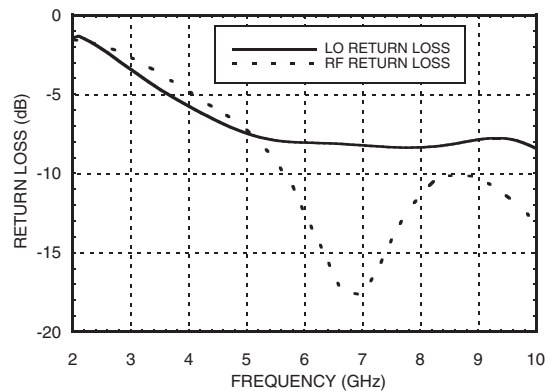

**IF Bandwidth @ LO = +15 dBm**

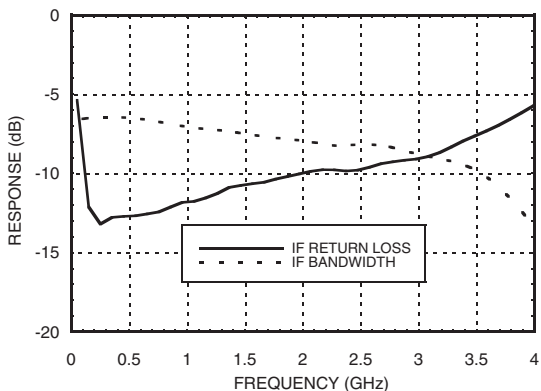

**Unconverter Performance**  
**Conversion Gain vs. LO Drive**

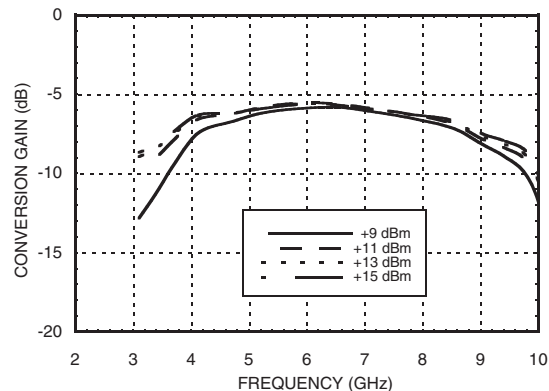

## GaAs MMIC DOUBLE-BALANCED MIXER, 4 - 8 GHz

4

MIXERS - DOUBLE-BALANCED - CHIP

**Input IP3 vs. LO Drive**

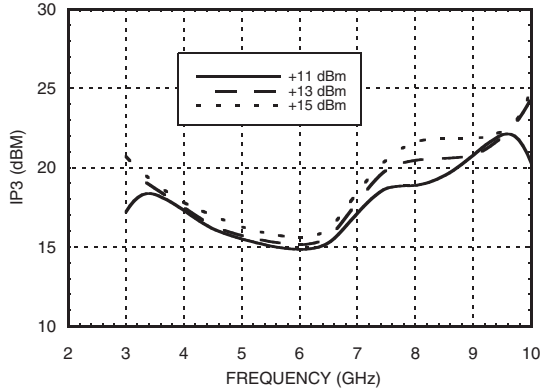

**Input IP3 vs. Temperature @ LO = +15 dBm**

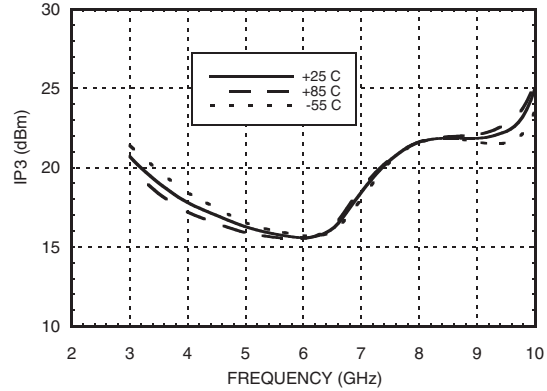

**Input IP2 vs. LO Drive**

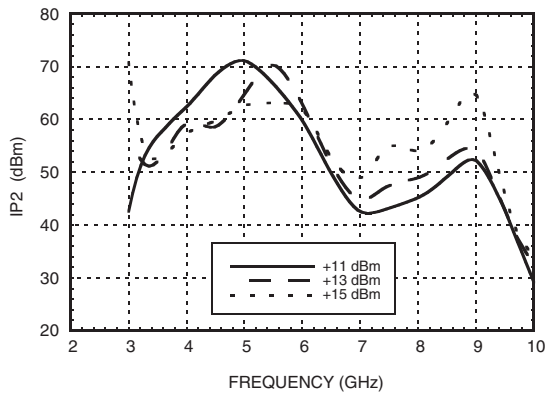

**Input IP2 vs. Temperature @ LO = +15 dBm**

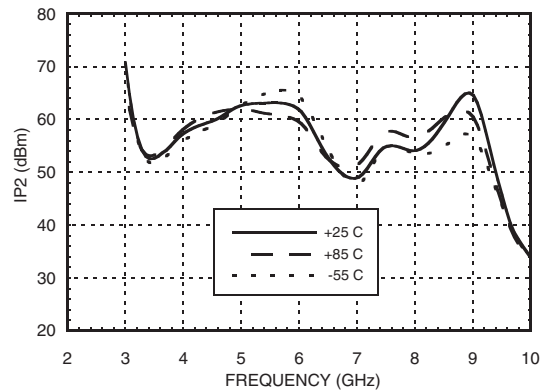

**Input P1dB vs. Temperature @ LO = +15 dBm**

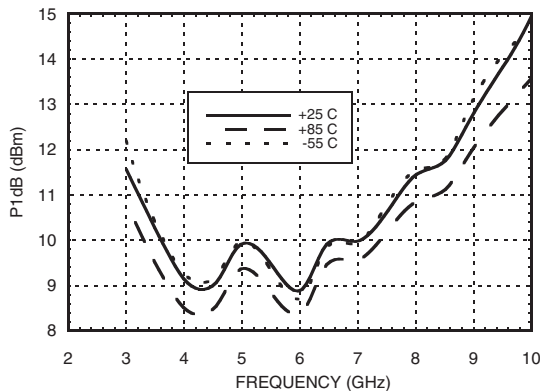

**Harmonics of LO**

LO Freq. (GHz)	nLO Spur @ RF Port			
	1	2	3	4
4	-30.7	-33.5	-32.7	-56.7
5	-29.2	-57.3	-64.8	-43.8
6	-24.7	-41.8	-35.0	-43.0
7	-19.7	-42.5	-20.5	-45.7
8	-23.3	-45.7	-22.5	-46.8
9	-17.2	-36.8	-26.7	-68.7

LO = +13 dBm  
All values in dBc below input LO level measured at RF port

**GaAs MMIC DOUBLE-BALANCED  
MIXER, 4 - 8 GHz**

**MxN Spurious @ IF Port**

mRF	nLO				
	0	1	2	3	4
0	xx	13.66	26.83	9.16	38.33
1	8.16	0	31.33	49.33	43.5
2	78.5	80.16	75.16	79.16	76.66
3	76.0	80.0	81.16	64.5	78.66
4	73.83	77.83	80.0	81.83	82.0

RF Freq. = 6.1 GHz @ -10 dBm  
LO Freq. = 6.0 GHz @ +13 dBm  
Measured as downconverter

**Absolute Maximum Ratings**

LO Drive	+27 dBm
Storage Temperature	-65 to +150 °C
Operating Temperature	-55 to +85 °C



**ELECTROSTATIC SENSITIVE DEVICE  
OBSERVE HANDLING PRECAUTIONS**

**Outline Drawing**

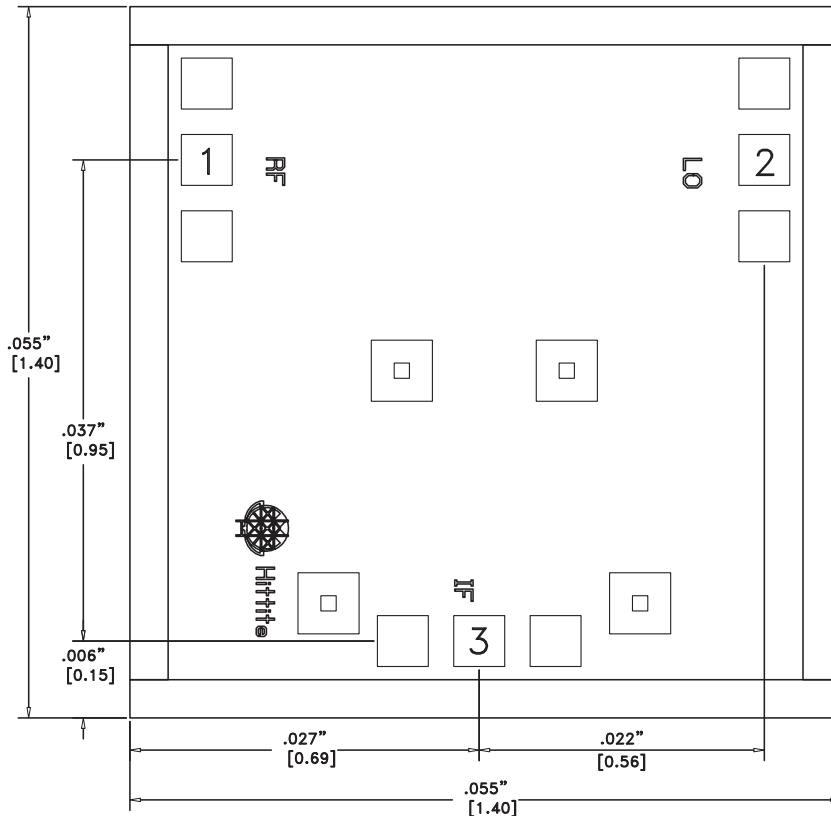

**Die Packaging Information [1]**

Standard	Alternate
WP-3 (Waffle Pack)	[2]

[1] Refer to the "Packaging Information" section for die packaging dimensions.



[2] For alternate packaging information contact Hittite Microwave Corporation.

**NOTES:**

1. ALL DIMENSIONS ARE IN INCHES [MM]
2. BOND PADS ARE .004" SQUARE
3. TYPICAL BOND PAD SPACING CENTER TO CENTER  
.1 IS .006" EXCEPT AS SHOWN
4. DIE THICKNESS = .004" [100 MM]
5. BACKSIDE METALIZATION: GOLD
6. BACKSIDE METAL IS GROUND
7. BOND PAD METALIZATION: GOLD

**GaAs MMIC DOUBLE-BALANCED  
MIXER, 4 - 8 GHz**

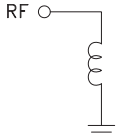
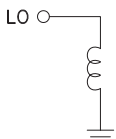
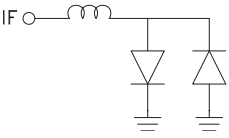
**Pad Descriptions**

Pad Number	Function	Description	Interface Schematic
1	RF	This pin is DC coupled and matched to 50 Ohms.	
2	LO	This pin is DC coupled and matched to 50 Ohms.	
3	IF	This pin is DC coupled. For applications not requiring operation to DC, this port should be DC blocked externally using a series capacitor whose value has been chosen to pass the necessary IF frequency range. For operation to DC this pin must not source or sink more than 2mA of current or die non-function and possible die failure will result.	
	GND	The backside of the die must connect to RF ground.	

### Assembly Diagram

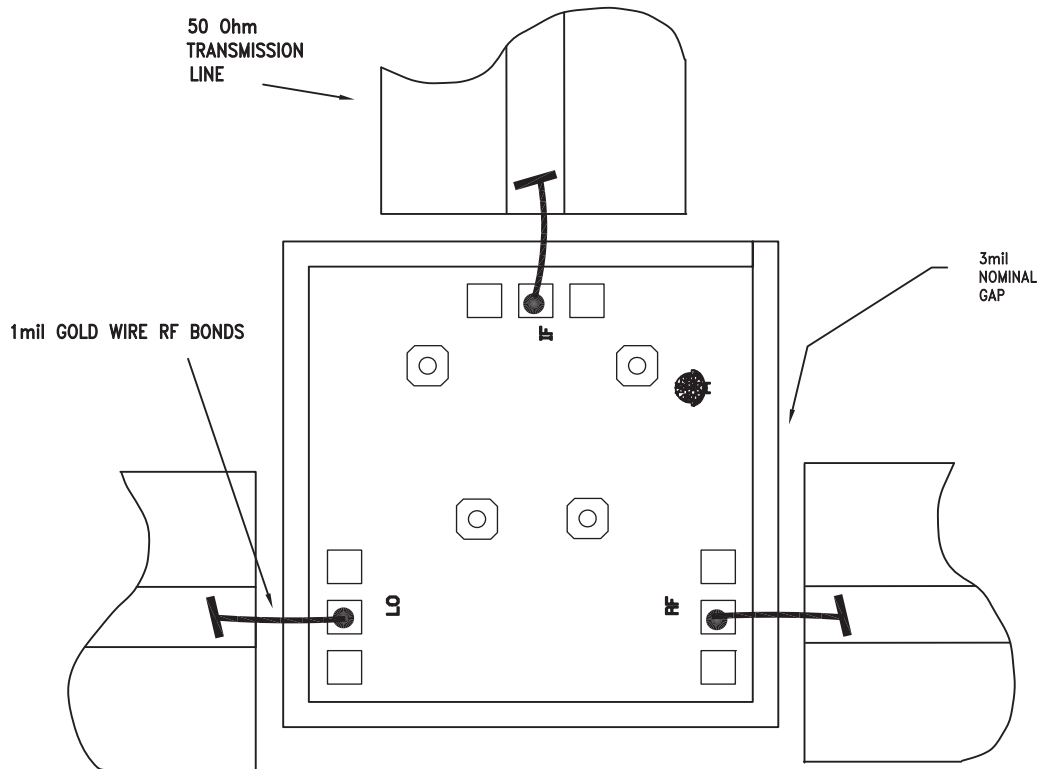

### Handling Precautions

Follow these precautions to avoid permanent damage.

**Storage:** All bare die are placed in either Waffle or Gel based ESD protective containers, and then sealed in an ESD protective bag for shipment. Once the sealed ESD protective bag has been opened, all die should be stored in a dry nitrogen environment.

**Cleanliness:** Handle the chips in a clean environment. DO NOT attempt to clean the chip using liquid cleaning systems.

**Static Sensitivity:** Follow ESD precautions to protect against ESD strikes.

**Transients:** Suppress instrument and bias supply transients while bias is applied. Use shielded signal and bias cables to minimize inductive pick-up.

**General Handling:** Handle the chip along the edges with a vacuum collet or with a sharp pair of bent tweezers. The surface of the chip has fragile air bridges and should not be touched with vacuum collet, tweezers, or fingers.

### Mounting

The chip is back-metallized and can be die mounted with AuSn eutectic preforms or with electrically conductive epoxy. The mounting surface should be clean and flat.

**Eutectic Die Attach:** A 80/20 gold tin preform is recommended with a work surface temperature of 255 °C and a tool temperature of 265 °C. When hot 90/10 nitrogen/hydrogen gas is applied, tool tip temperature should be 290 °C. DO NOT expose the chip to a temperature greater than 320 °C for more than 20 seconds. No more than 3 seconds of scrubbing should be required for attachment.

**Epoxy Die Attach:** Apply a minimum amount of epoxy to the mounting surface so that a thin epoxy fillet is observed around the perimeter of the chip once it is placed into position. Cure epoxy per the manufacturer's schedule.

### Wire Bonding

Ball or wedge bond with 0.025 mm (1 mil) diameter pure gold wire. Thermosonic wirebonding with a nominal stage temperature of 150 °C and a ball bonding force of 40 to 50 grams or wedge bonding force of 18 to 22 grams is recommended. Use the minimum level of ultrasonic energy to achieve reliable wirebonds. Wirebonds should be started on the chip and terminated on the package or substrate. All bonds should be as short as possible <0.31 mm (12 mils).