

DETAILS

Product Number	CA11052_TINA2-O
Family	Tina
Type	Assembly
Color	black
Diameter	16,1 mm
Height	9,7 mm
Style	round
Optic Material	PMMA
Holder Material	
Fastening	tape
Status	production ready
ROHS Compliant	Yes
Date Updated	11/11/2016



OPTICAL PROPERTIES

LED	Viewing Angle	Light Beam	Efficiency	cd/lm	Connector
XP-E	32+14 deg	Oval	87 %	4.400	-
XP-G	35+16 deg	Oval	87 %	3.900	-
XP-E-HEW	34+16 deg	Oval	-	3.360	-
XT-E	35+16 deg	Oval	85 %	3.800	-
XP-G2	34+16 deg	Oval	87 %	4.000	-
XP-E2	34+14 deg	Oval	86 %	5.100	-
H35C0 (LEMWA33)	33+17 deg	Oval	86 %	3.500	-
H35B0 (LEMWA32)	35+15 deg	Oval	86 %	4.200	-
H35C1 (LEMWA33)	35+17 deg	Oval	85 %	3.900	-
Fortimo FastFlex LED board 2x8/757 DS	34+16 deg	Oval	83 %	3.800	-
Z5	sim: 41+15	Oval	sim: 90 %	sim: 4.200	-

D

C

B

A

4

4

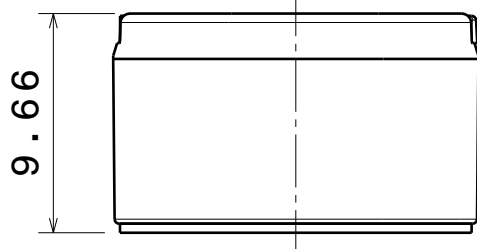

Front view

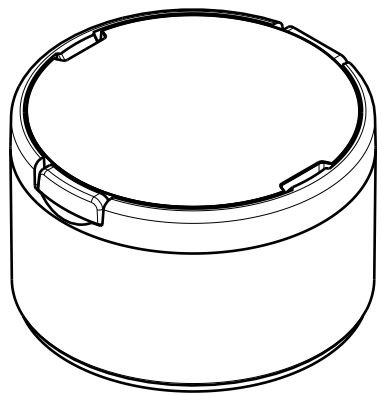

Isometric view
Scale: 3:1

3

3

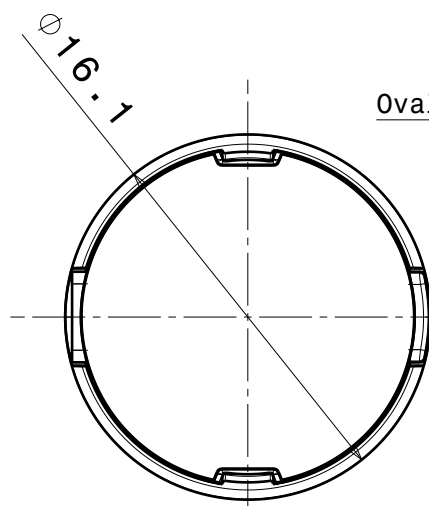

Top view

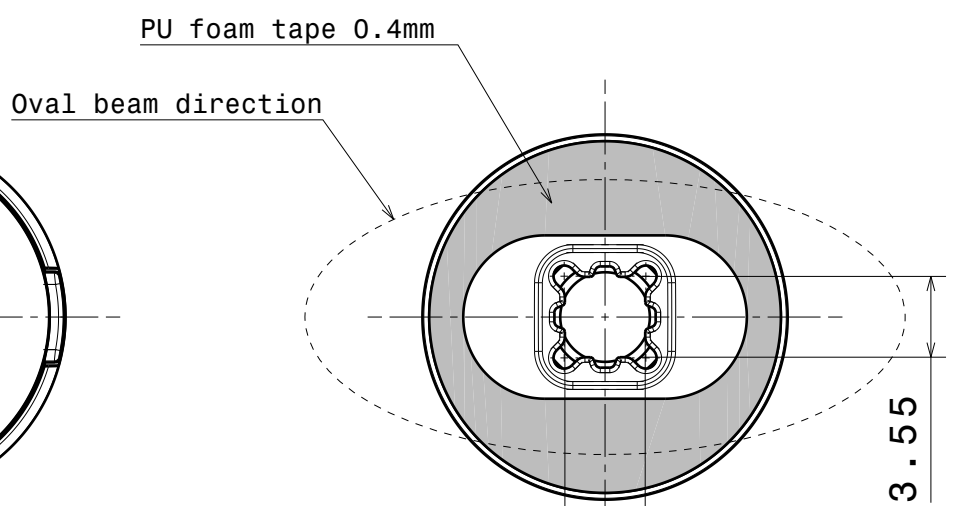

Bottom view

2

2

INDEX	PART NO	DESCRIPTION	MATERIAL	COLOUR
1	C11418	TINA2-XP-HLD-TAPE-BLK	PC	black
2	C11050	TINA2-XP-0	PMMA	

Tolerances if not otherwise shown
According to DIN ISO 2768-1
Linear measures:
Up to 30mm class M, otherwise class C.
According to DIN ISO 2768-2
Form and position: class L

LEDiL LediL Oy
Salorankatu 10
FIN 24240 SALO
Finland

THIRD ANGLE PROJECTION:

DRAWING TITLE
CA11052_TINA2-0

This drawing is the property of LEDiL Oy. It may not be reproduced, copied or communicated without a written agreement with LEDiL Oy.

SIZE PART NUMBER
A4 CA11052

SCALE 3:1 WEIGHT 1,3 g SHEET 1/1

1

1

D

A

Ledil Oy CA11052_Tina2-XP-O-black Cree XP-E (white) 76lm @ 250mA LOR is 91% / LDC (Linear)

Luminaire: Ledil Oy CA11052_Tina2-XP-O-black Cree XP-E (white) 76lm @ 250mA LOR is 91%
Lamps: 1 x Cree XP-E (white) 76lm @ 250mA

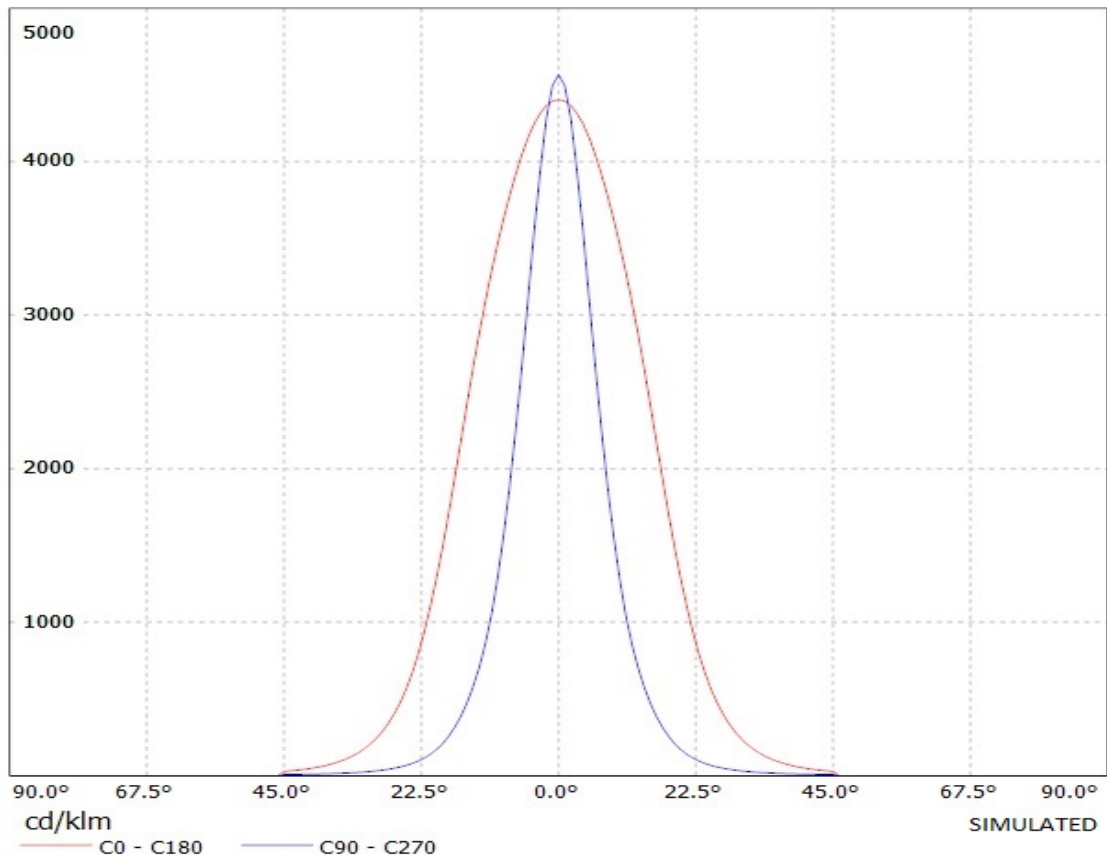

Luminaire: LEDIL OY CA11052_Tina2-O (XP-G) Efficiency=87%
Lamps: 1 x Cree XP-G (92lm@250mA)

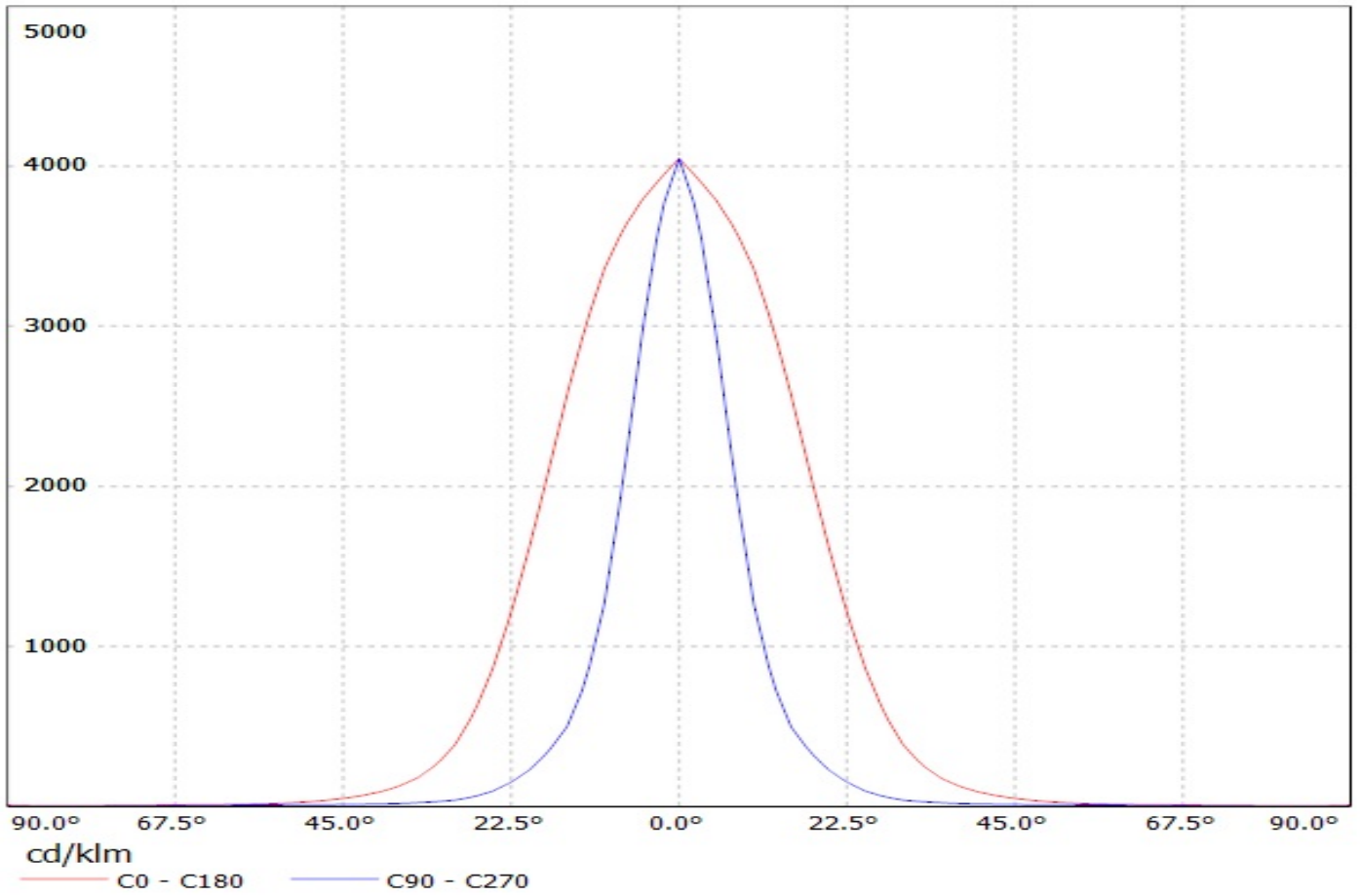

Luminaire: Ledil Oy CA11052_TINA2-O-XT-E (AWT) Efficiency=88%
Lamps: 1 x Cree XT-E (AWT) 250mA

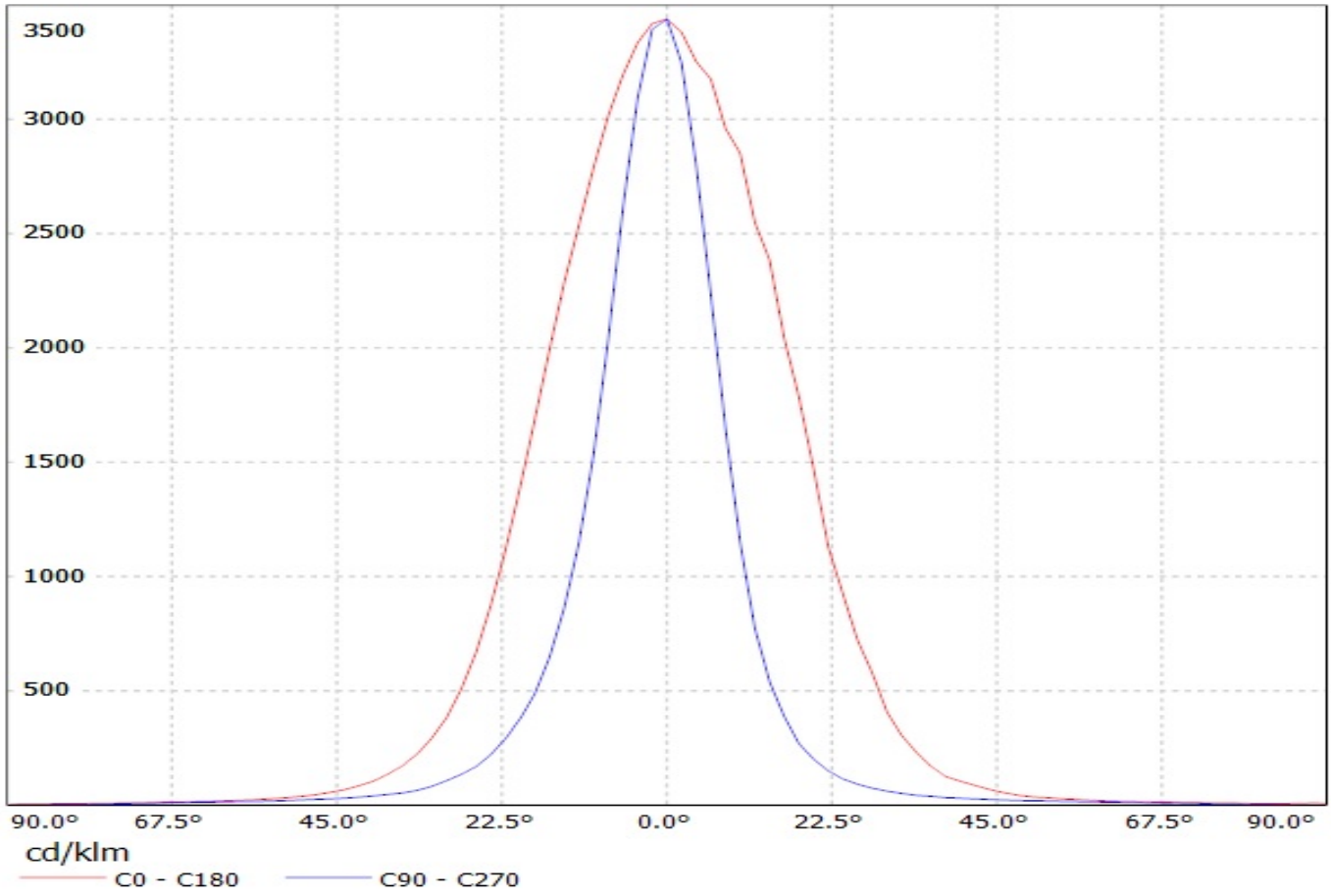

Valaisin: LEDIL OY CA11052_TINA2-O_(XP-G2) Efficiency=87%
Lamput: 1 x Cree XP-G2 (109.1lm @ 250mA)

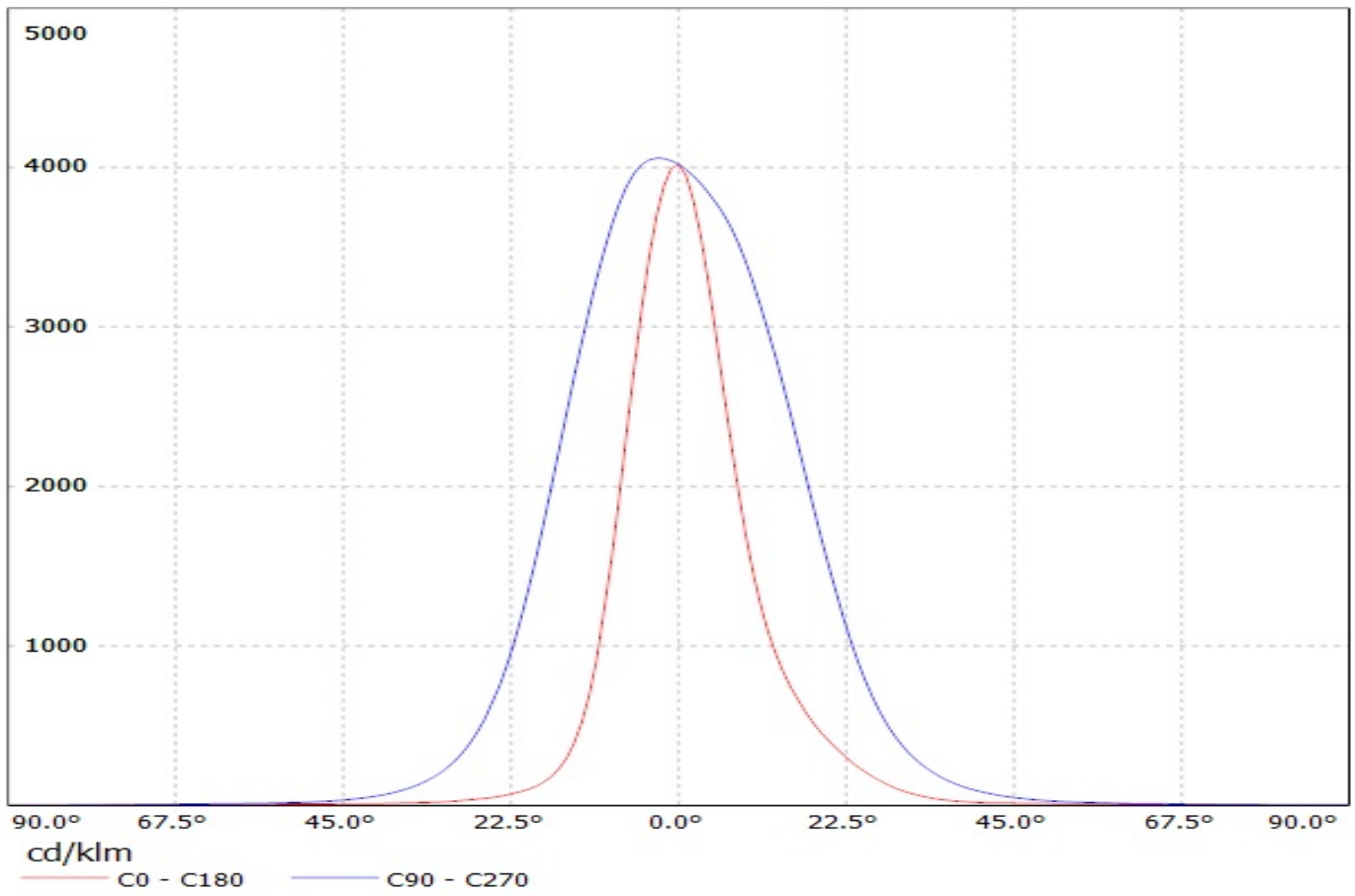

Luminaire: Ledil Oy CA11052_TINA2-O (CREE XP-E2 92 lm @ 250 mA) Efficiency=86%
Lamps: 1 x CREE XP-E2 92 lm @ 250 mA

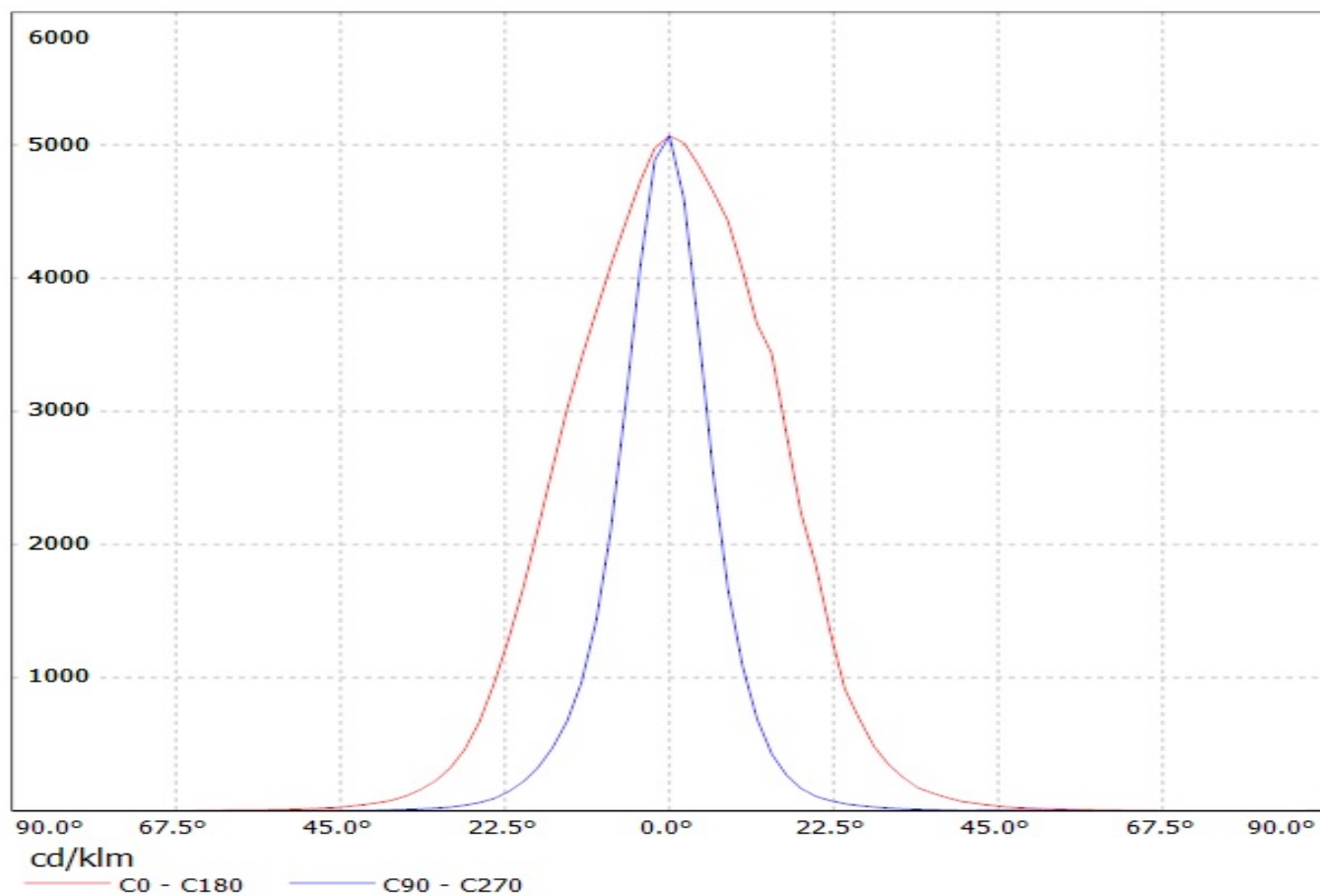

LEDiL Oy CA11052_TINA2-O_(3535_Ceramic)_2 Eff.85.5% / LDC (Linear)

Luminaire: LEDiL Oy CA11052_TINA2-O_(3535_Ceramic)_2 Eff.85.5%

Lamps: 1 x LG 3535 Ceramic (95lm@250mA)

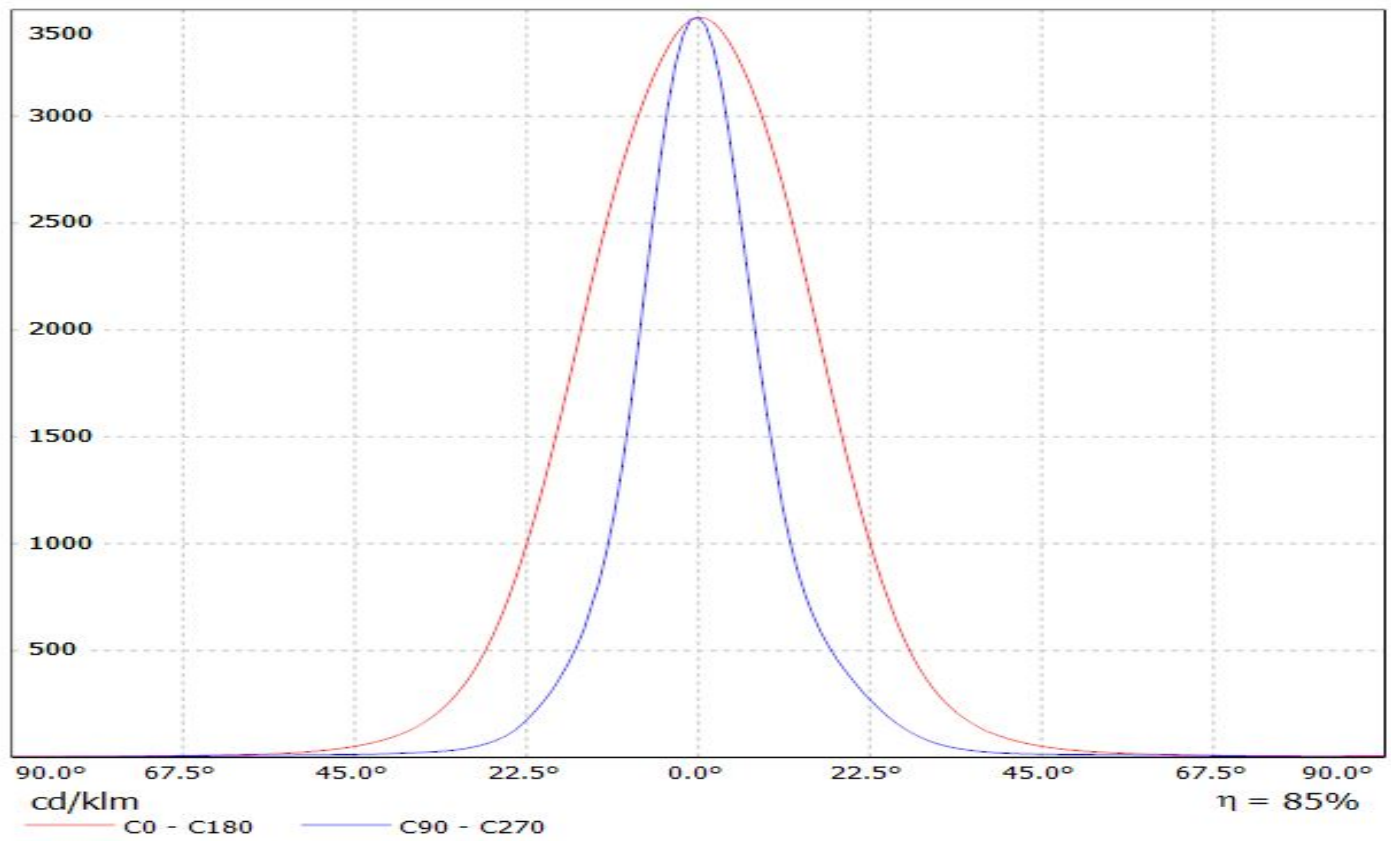

LEDiL Oy CA11052_TINA2_O_(LG3535_2W) Eff.86.5% / LDC (Linear)

Luminaire: LEDiL Oy CA11052_TINA2_O_(LG3535_2W) Eff.86.5%

Lamps: 1 x LG3535_2W (97.2479lm@250mA)

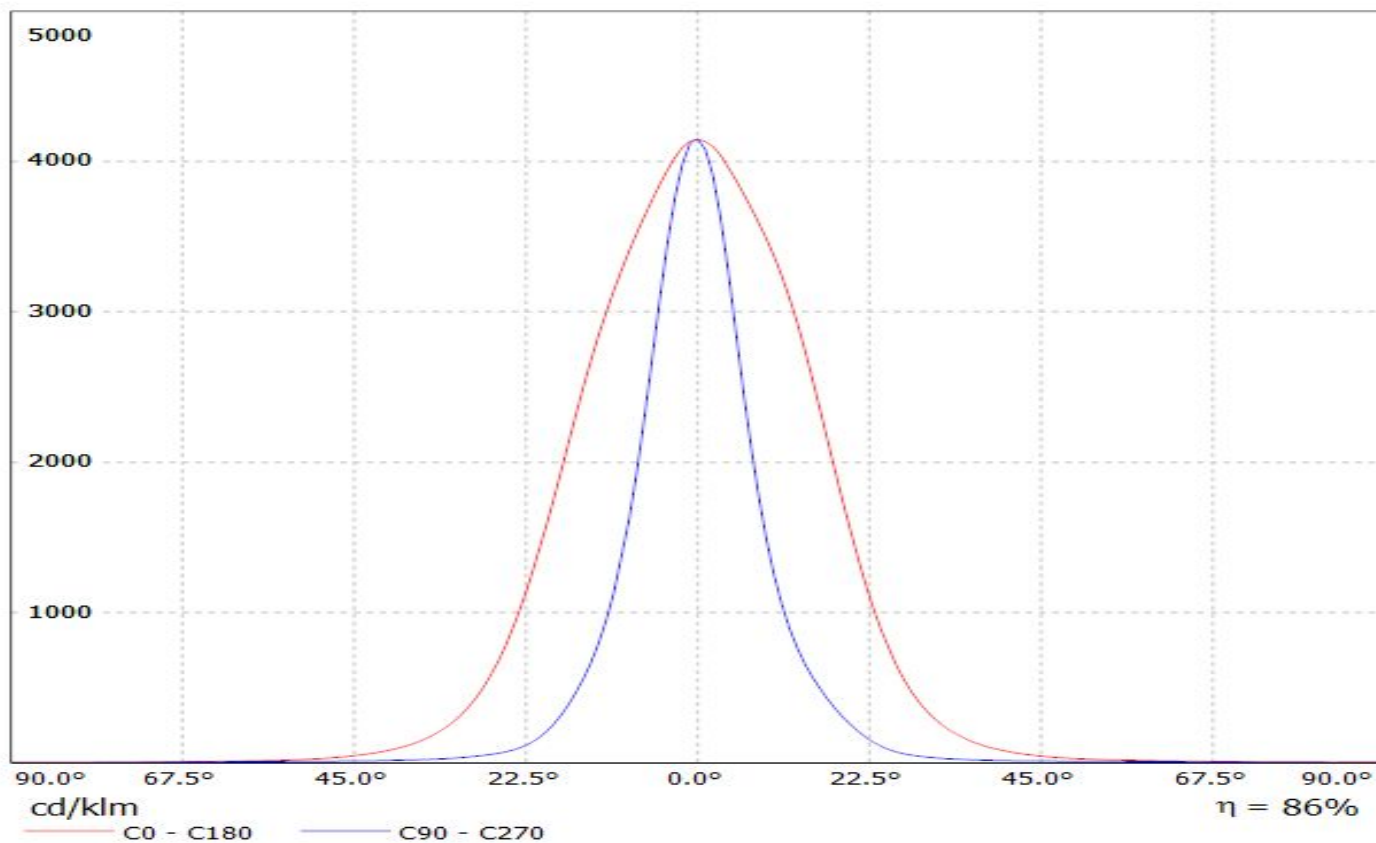

Luminaire: Ledil Oy CA11052_TINA2-O_(3535_Ceramic_gen2) Efficiency=85%
Lamps: 1 x LG 3535 Ceramic gen2 (PKG5700K) 116lm @ 250mA CCT=6200K P=0.7W I=250mA

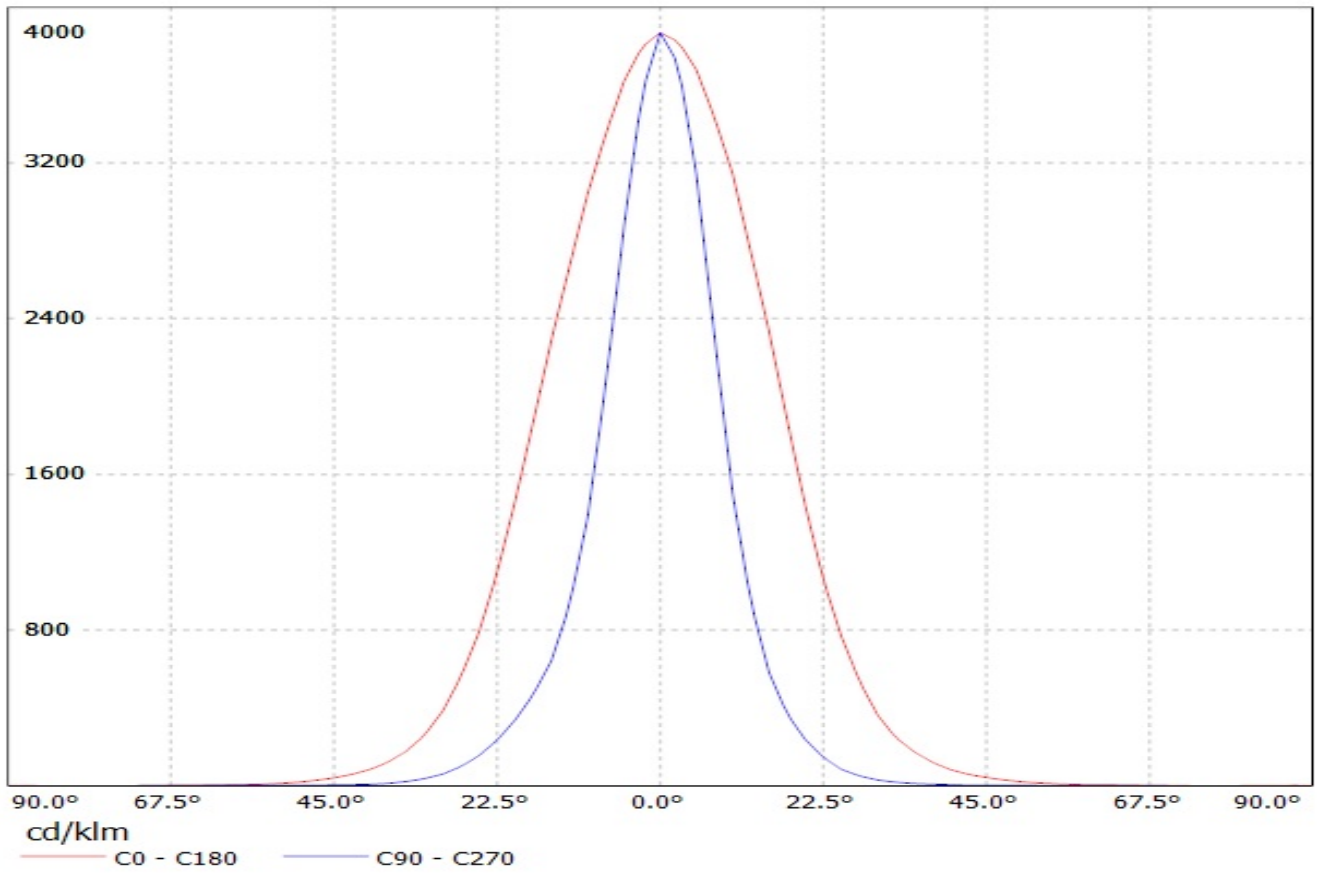

Ledil CA11052_TINA2-O_(Fortimo_FastFlex_LED_board 2x8-757_DS_G3) / LDC (Linear)

Luminaire: Ledil CA11052_TINA2-O_(Fortimo_FastFlex_LED_board 2x8-757_DS_G3)
Lamps: 1 x Philips_Fortimo_FastFlex_LED_board 2x8/757_DS_G3_(XP-G2)
_3428.78lm@500mA_P=23.7W_I=0.5A

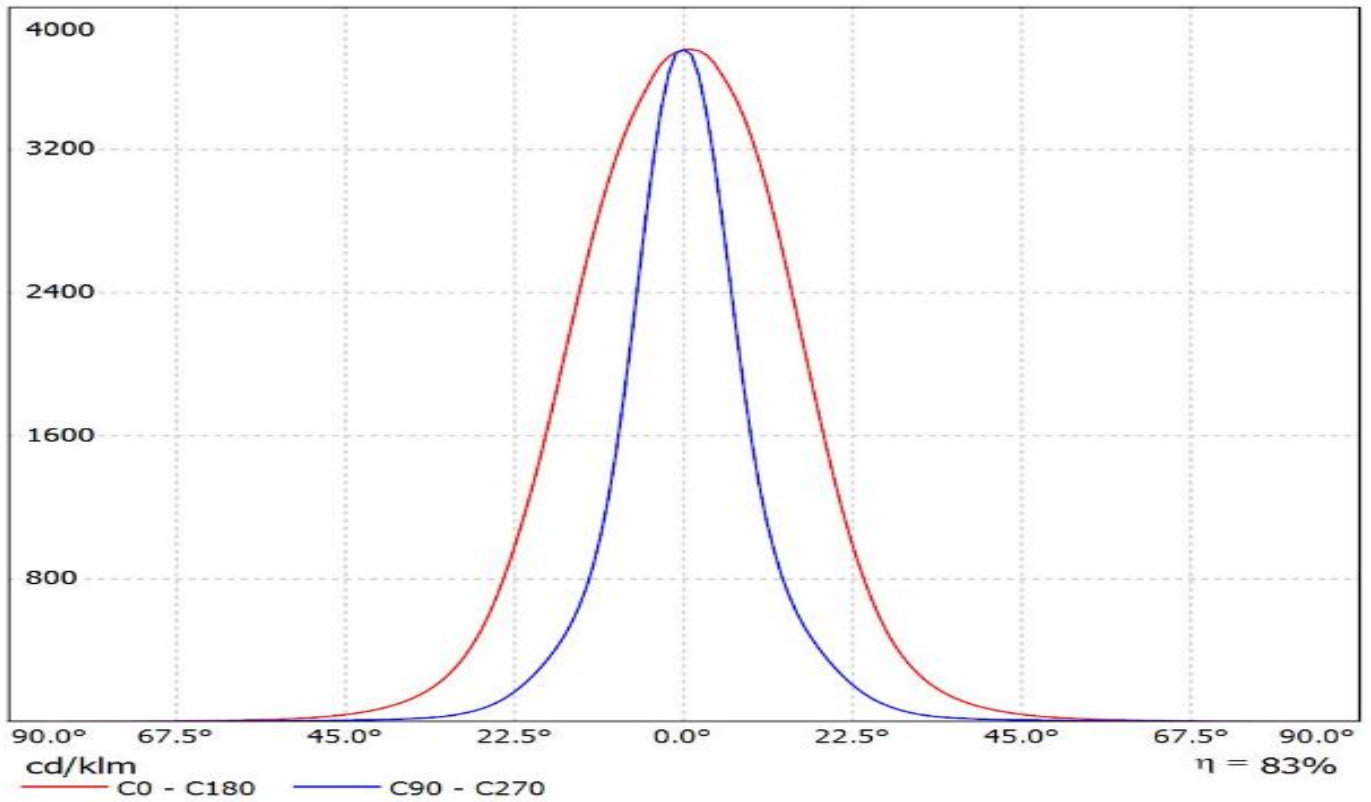

Luminaire: Ledil Oy CA11052_TINA2-O_(Z5)_SIMULATED
Lamps: 1 x Seoul Z5 (SZW05A0B)

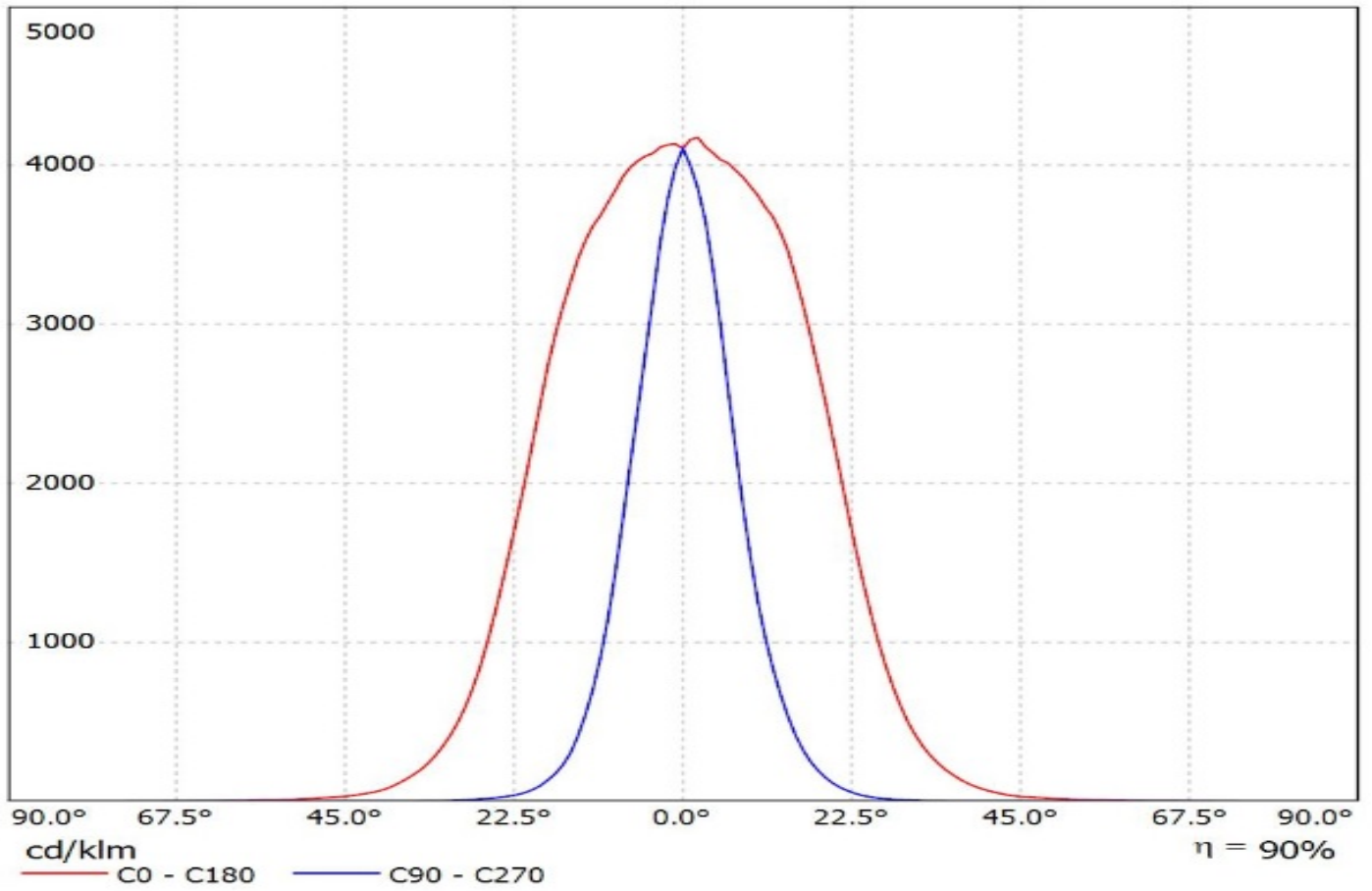

Ledil Oy CA11052_Tina2-XP-O-black Cree XP-E (white) 76lm @ 250mA LOR is 91% / LDC (Polar)

Luminaire: Ledil Oy CA11052_Tina2-XP-O-black Cree XP-E (white) 76lm @ 250mA LOR is 91%

Lamps: 1 x Cree XP-E (white) 76lm @ 250mA

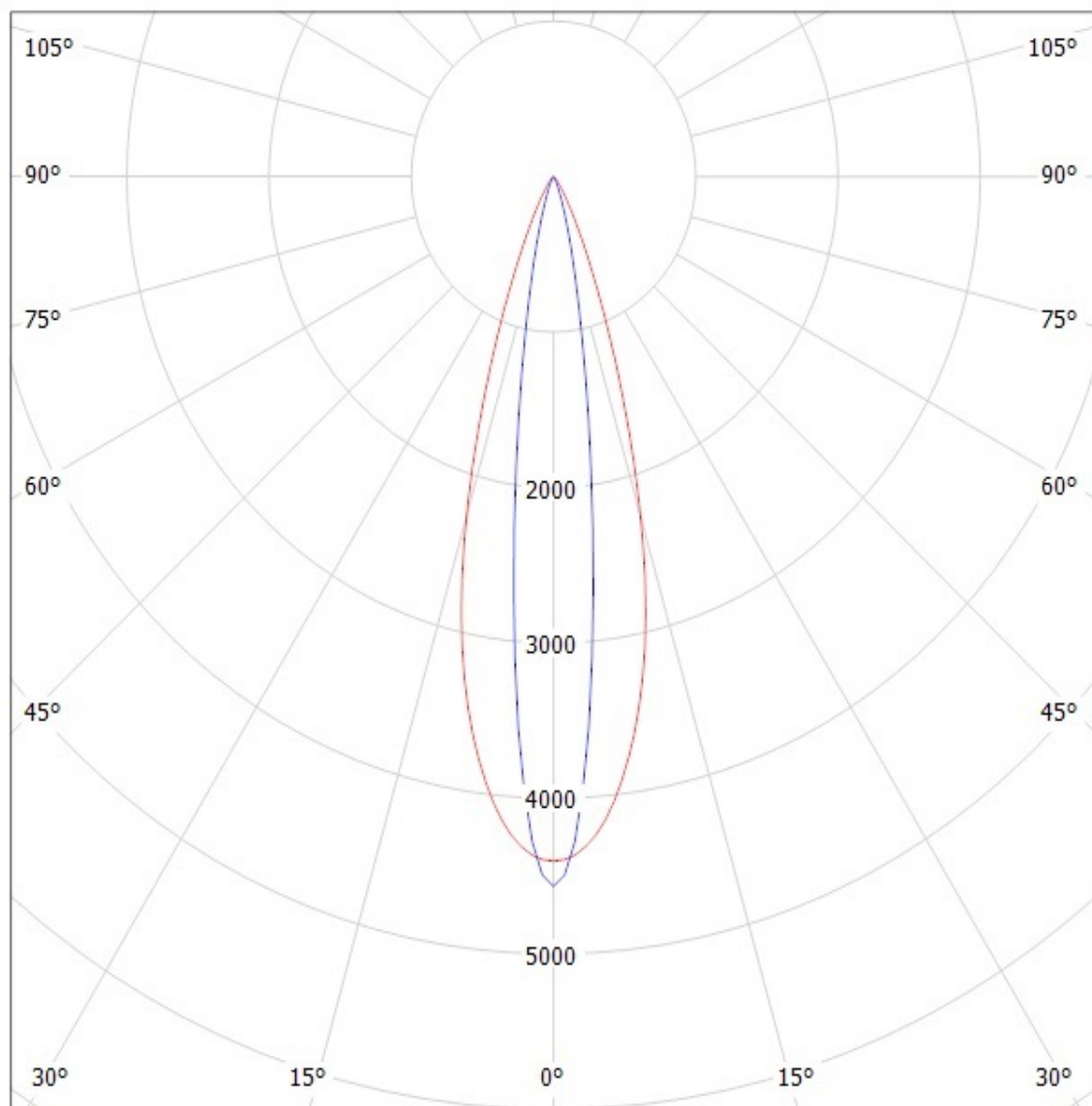

cd/klm

— C0 - C180

— C90 - C270

SIMULATED

Luminaire: LEDIL OY CA11052_Tina2-O (XP-G) Efficiency=87%
Lamps: 1 x Cree XP-G (92lm@250mA)

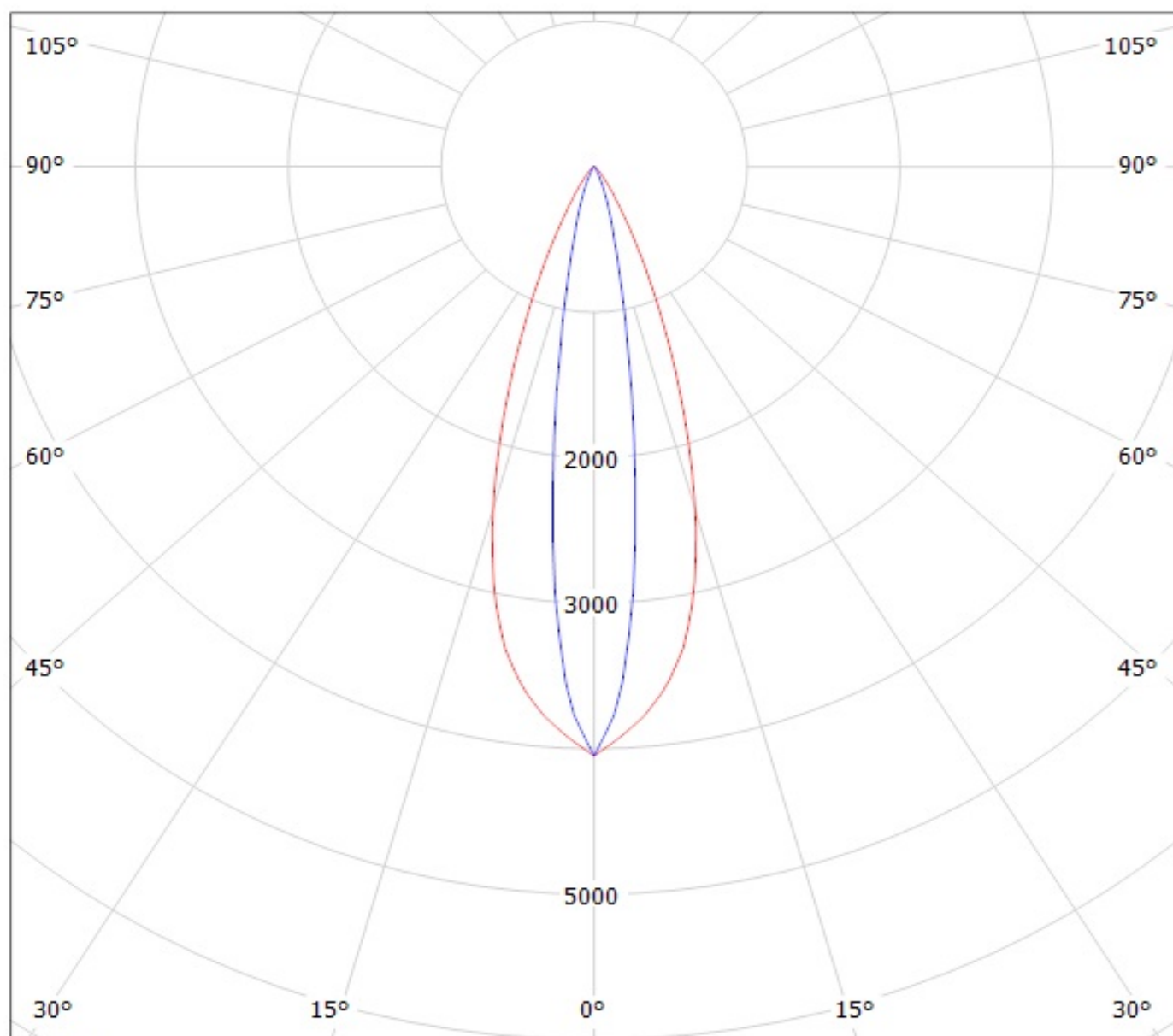

cd/klm

— C0 - C180

— C90 - C270

Luminaire: Ledil Oy CA11052_TINA2-O-XT-E (AWT) Efficiency=88%
Lamps: 1 x Cree XT-E (AWT) 250mA

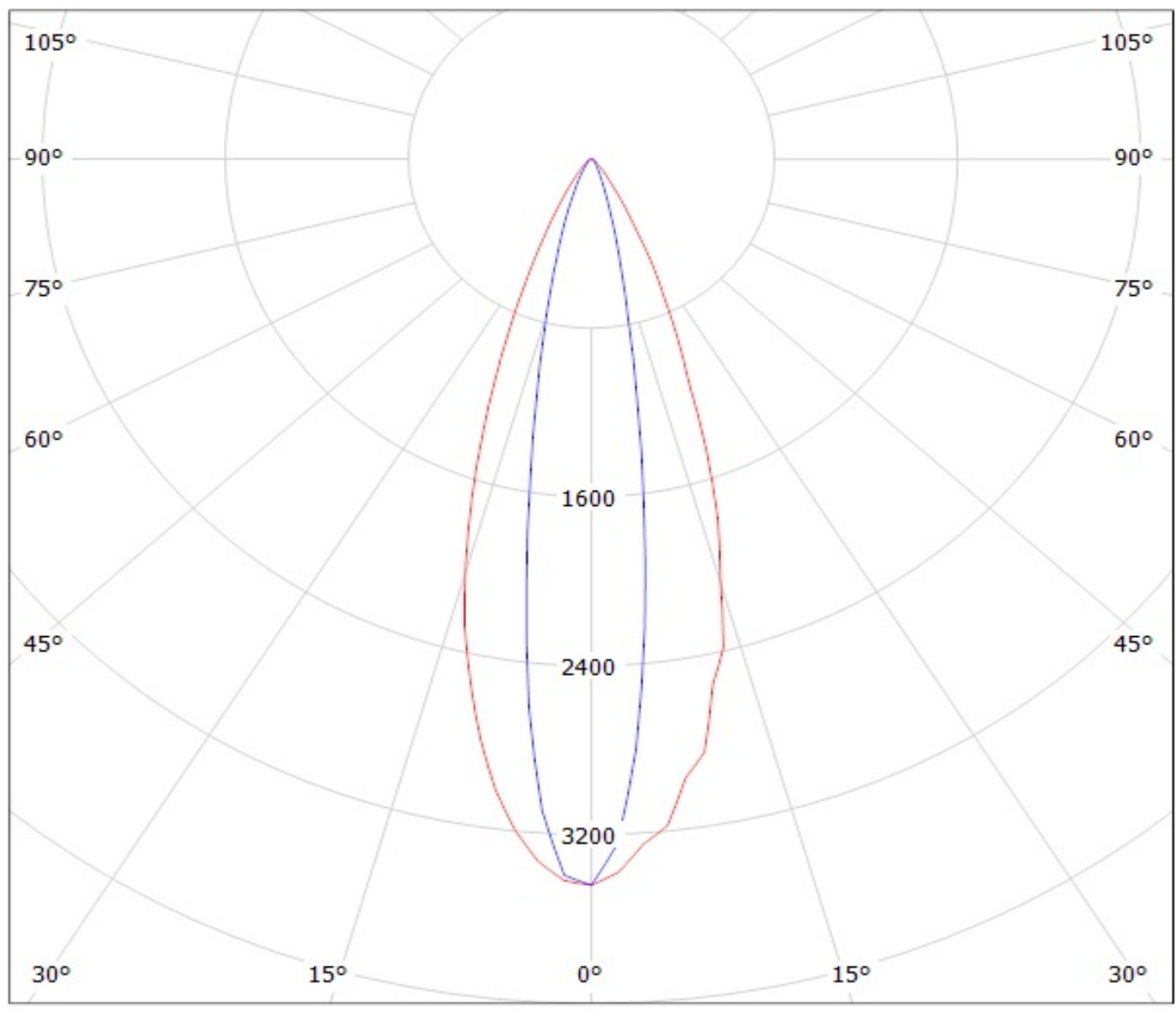

cd/klm
— C0 - C180 — C90 - C270

Valaisin: LEDIL OY CA11052_TINA2-O_(XP-G2) Efficiency=87%
Lamput: 1 x Cree XP-G2 (109.1lm @ 250mA)

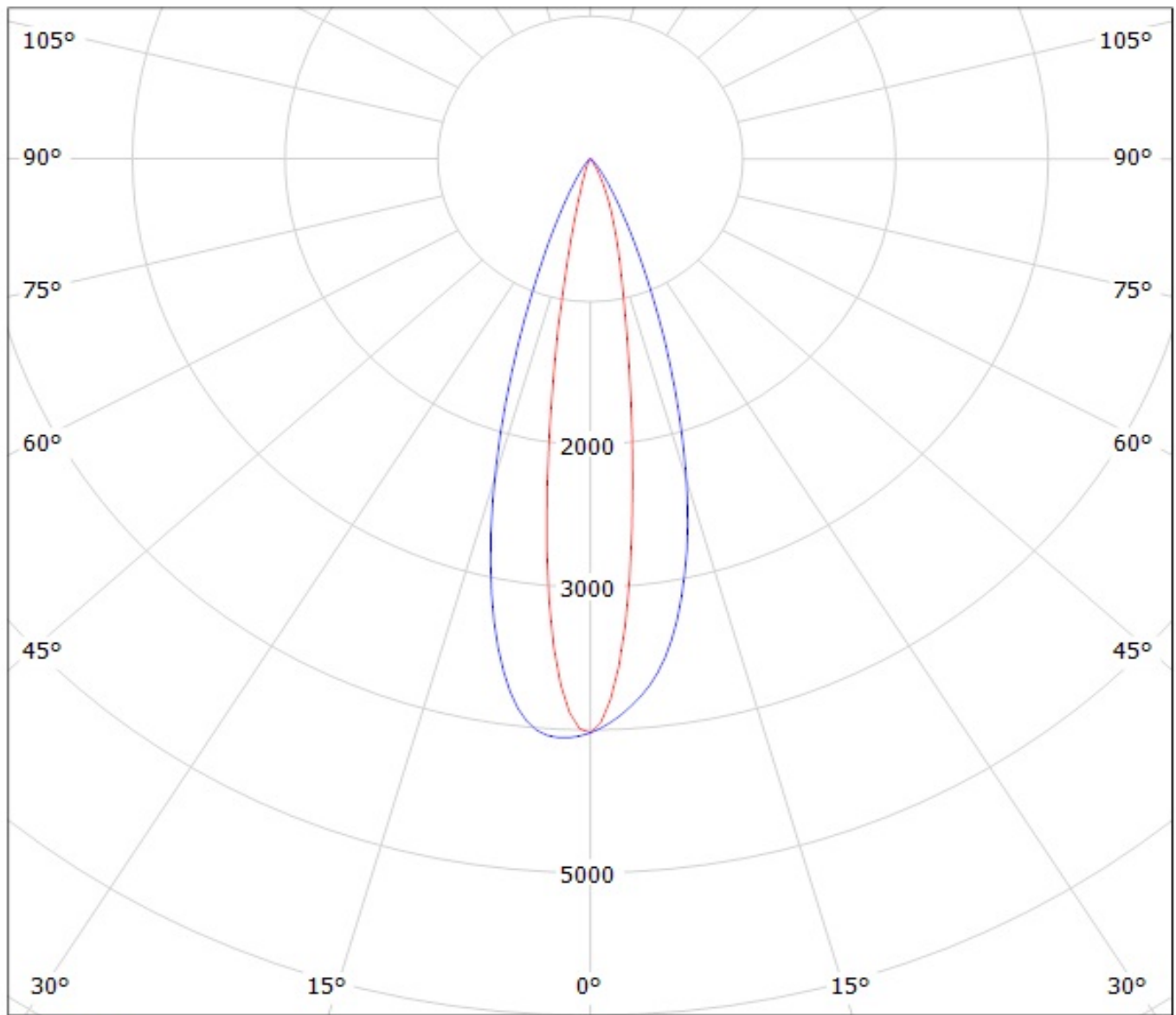

cd/klm

— C0 - C180

— C90 - C270

Luminaire: Ledil Oy CA11052_TINA2-O (CREE XP-E2 92 lm @ 250 mA) Efficiency=86%
Lamps: 1 x CREE XP-E2 92 lm @ 250 mA

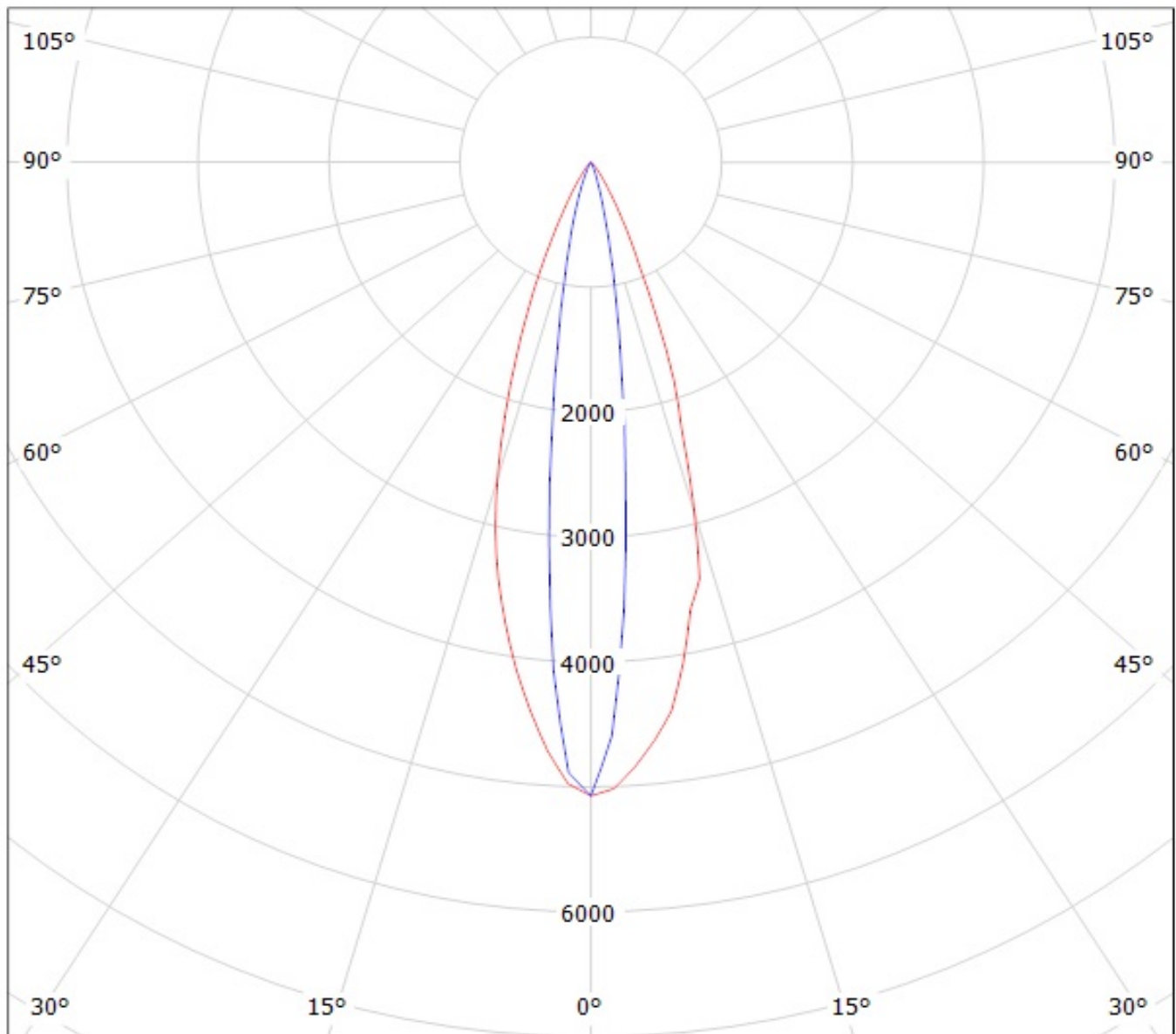

cd/klm

— C0 - C180 — C90 - C270

LEDiL Oy CA11052_TINA2-O_(3535_Ceramic)_2 Eff.85.5% / LDC (Polar)

Luminaire: LEDiL Oy CA11052_TINA2-O_(3535_Ceramic)_2 Eff.85.5%

Lamps: 1 x LG 3535 Ceramic (95lm@250mA)

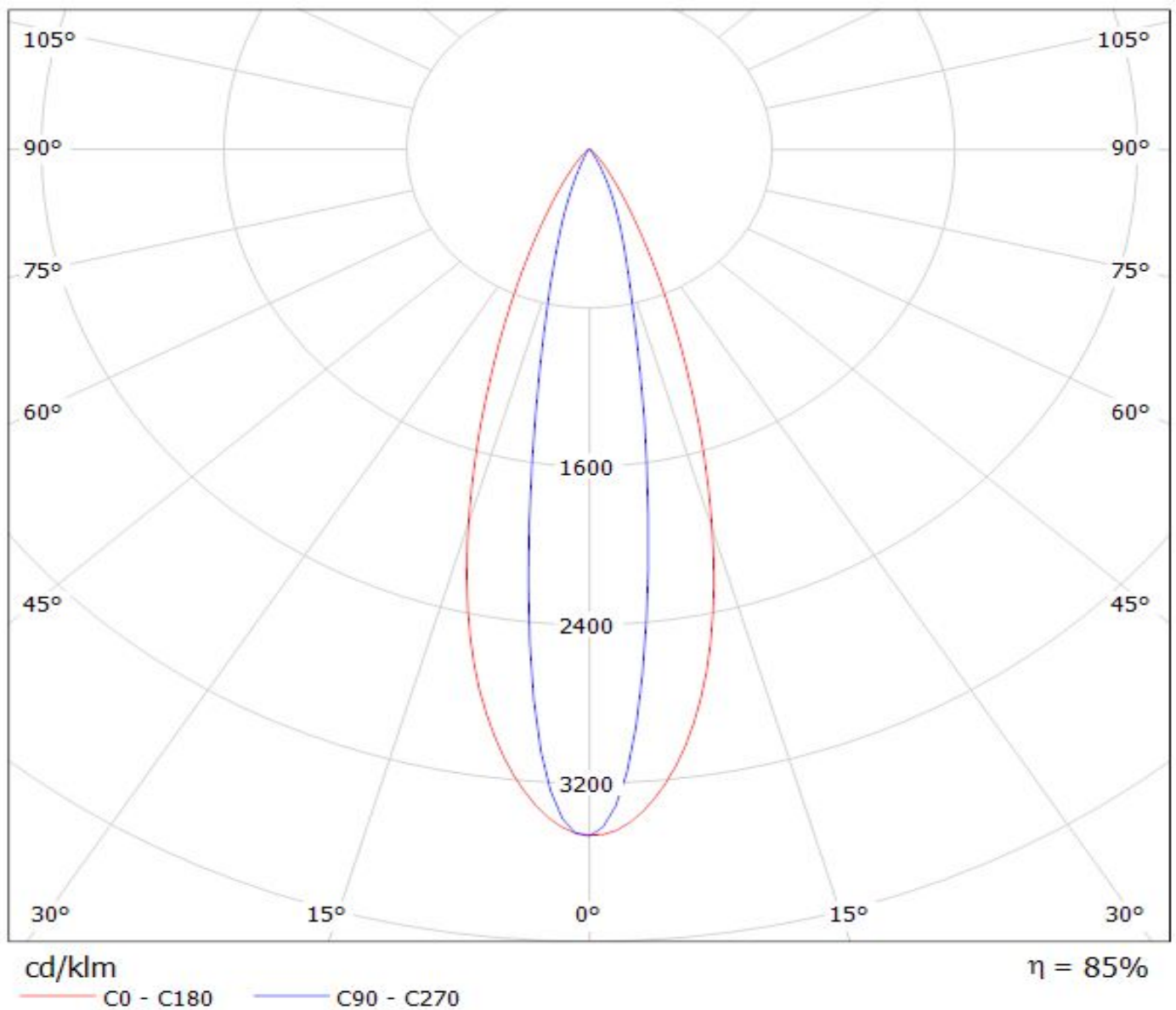

LEDiL Oy CA11052_TINA2_O_(LG3535_2W) Eff.86.5% / LDC (Polar)

Luminaire: LEDiL Oy CA11052_TINA2_O_(LG3535_2W) Eff.86.5%

Lamps: 1 x LG3535_2W (97.2479lm@250mA)

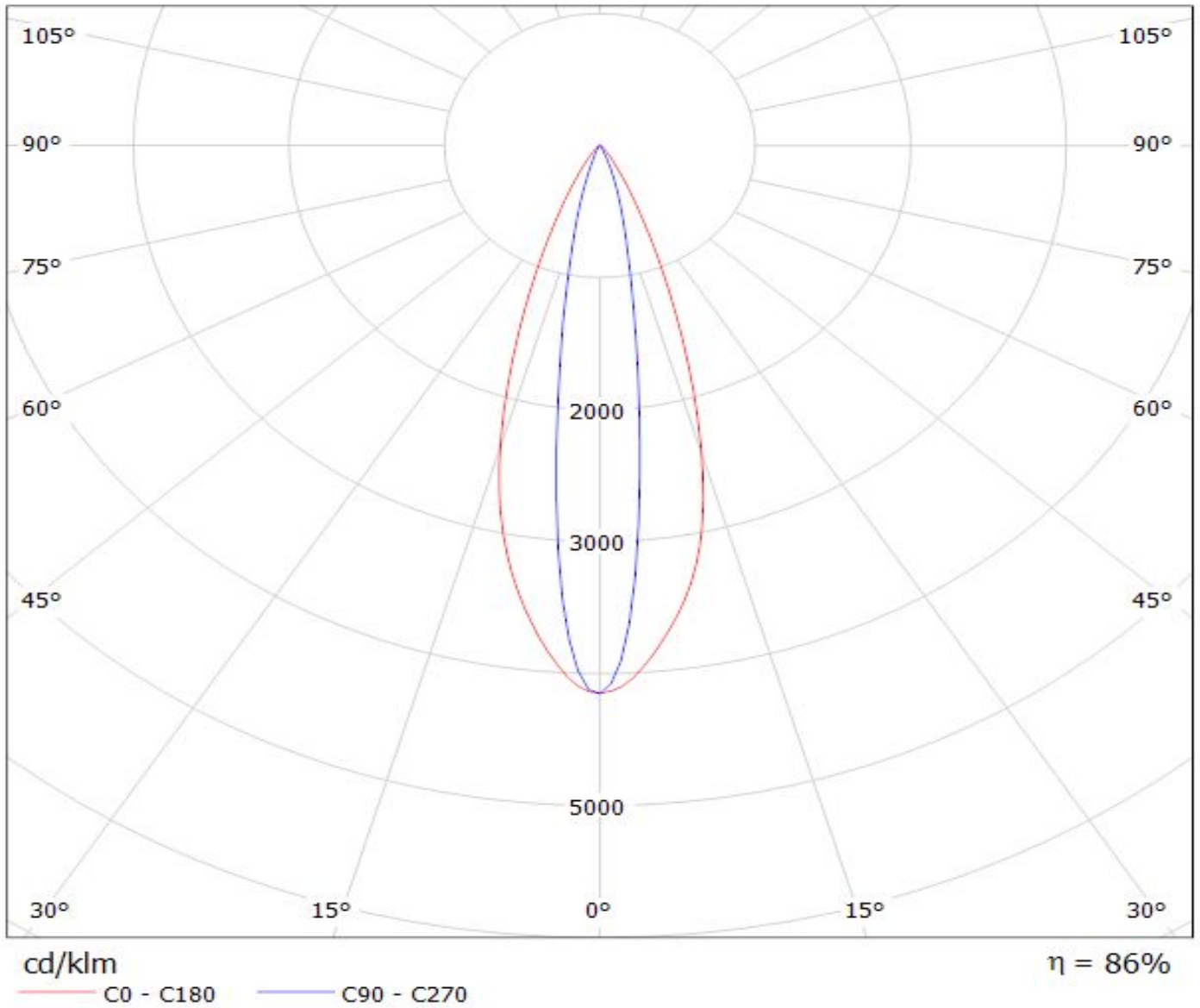

Luminaire: Ledil Oy CA11052_TINA2-O_(3535_Ceramic_gen2) Efficiency=85%
Lamps: 1 x LG 3535 Ceramic gen2 (PKG5700K) 116lm @ 250mA CCT=6200K P=0.7W I=250mA

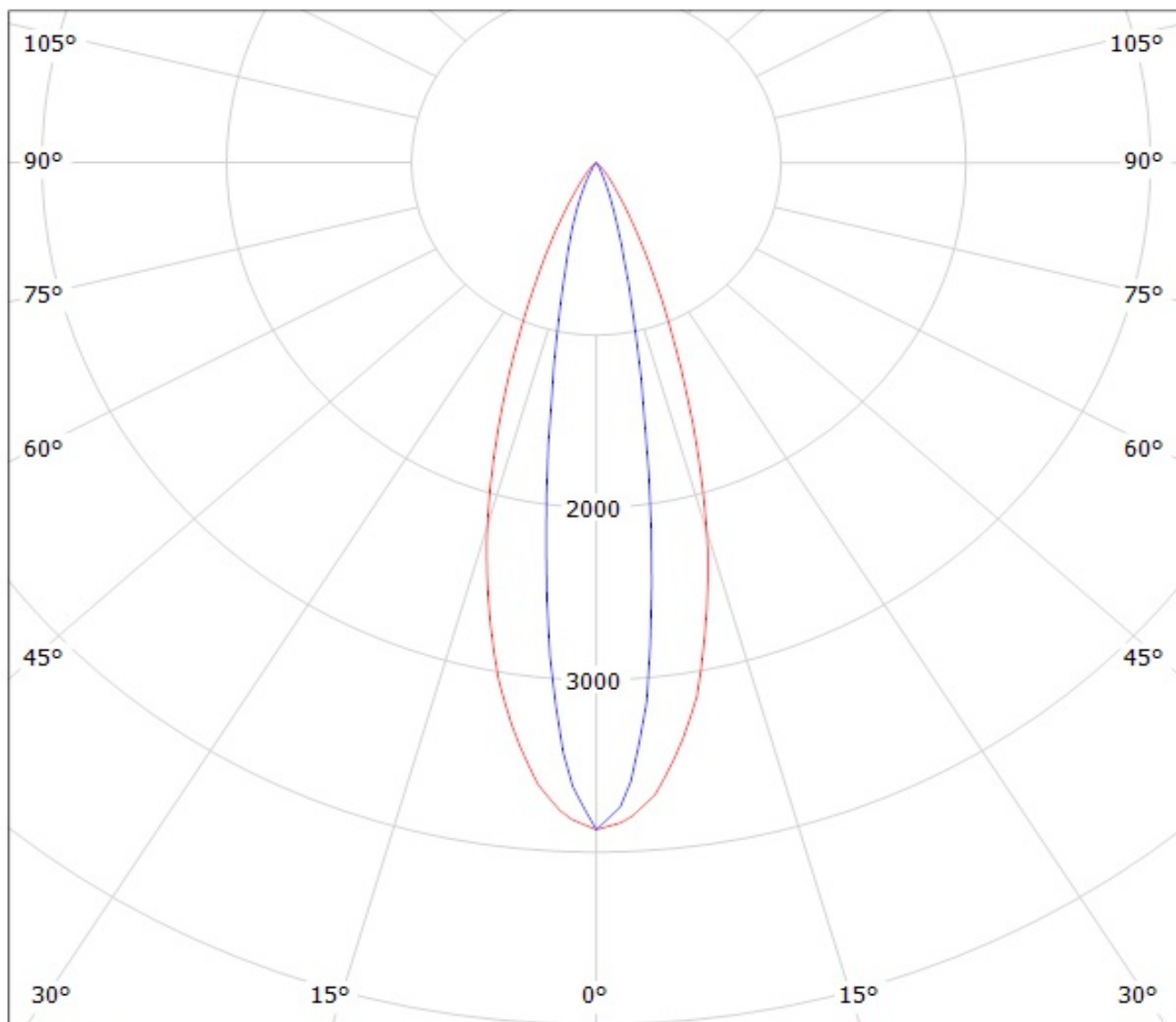

cd/klm

— C0 - C180 — C90 - C270

Ledil CA11052_TINA2-O_(Fortimo_FastFlex_LED_board 2x8-757_DS_G3) / LDC (Polar)

Luminaire: Ledil CA11052_TINA2-O_(Fortimo_FastFlex_LED_board 2x8-757_DS_G3)
Lamps: 1 x Philips_Fortimo_FastFlex_LED_board 2x8/757_DS_G3_(XP-G2)
_3428.78lm@500mA_P=23.7W_I=0.5A

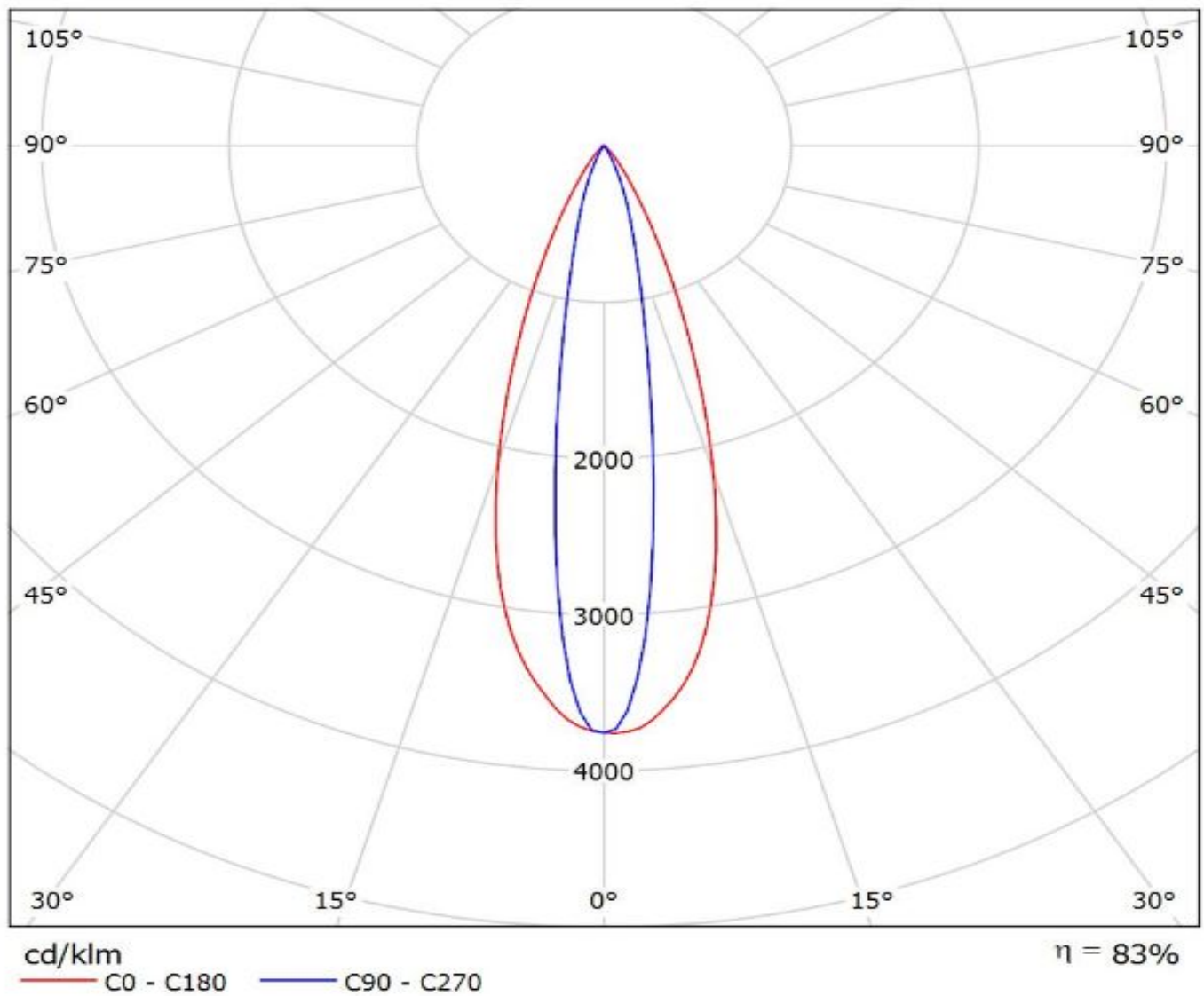

Luminaire: Ledil Oy CA11052_TINA2-O_(Z5)_SIMULATED
Lamps: 1 x Seoul Z5 (SZW05A0B)

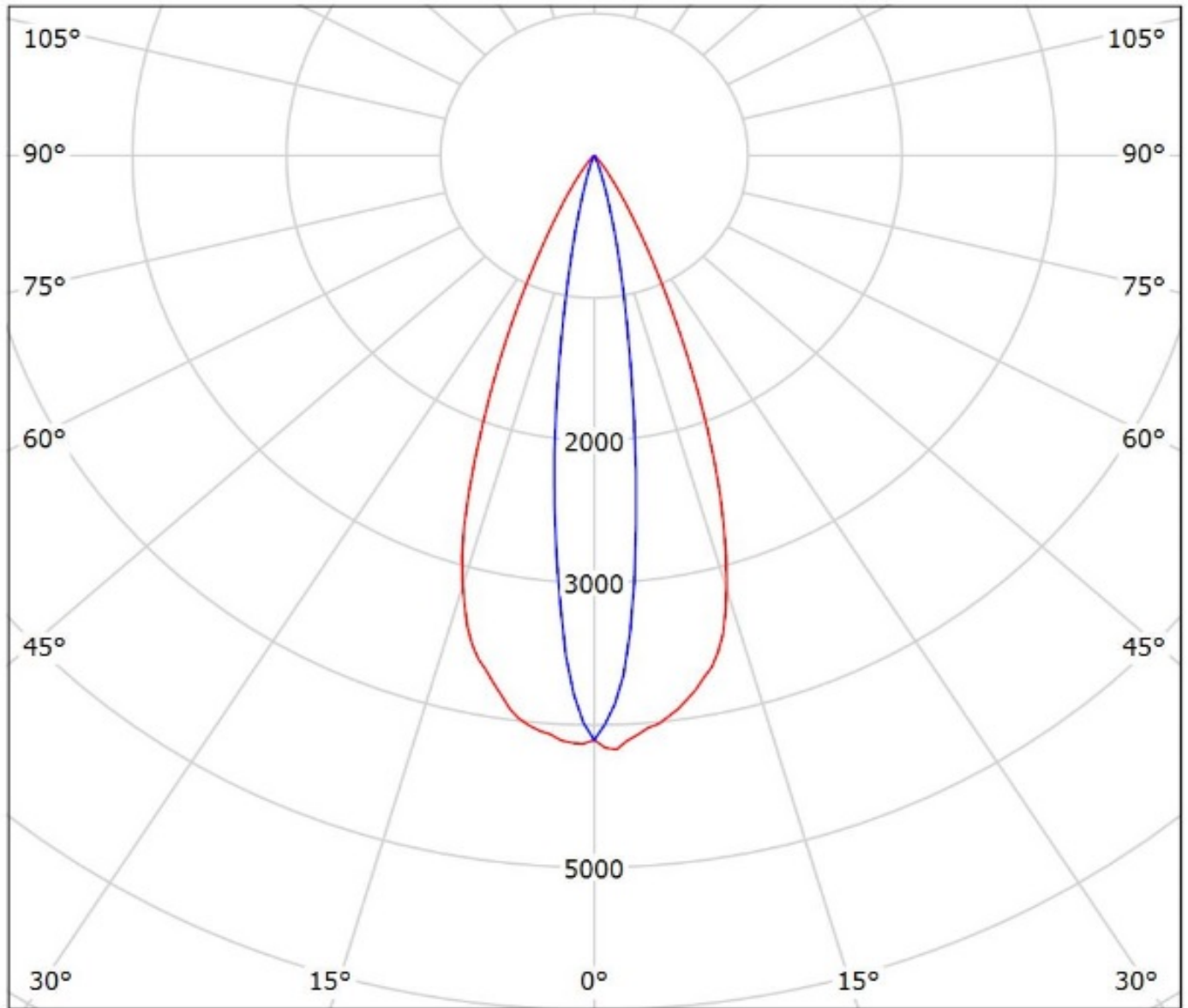

cd/klm

— C0 - C180 — C90 - C270

$\eta = 90\%$

NOTE: The typical divergence will be changed by different color, chip size and chip position tolerance. The typical total divergence is the full angle measured where the luminous intensity is half of the peak value.