

1

2

3

4

5

6

7

Signature	Revision History	Date	Rev.
Sean	For Bulk Production	Sep.17.2013	01

RoHS Compliant

DVI (24+1)P MALE

DVI (24+1)P MALE

2000±30MM

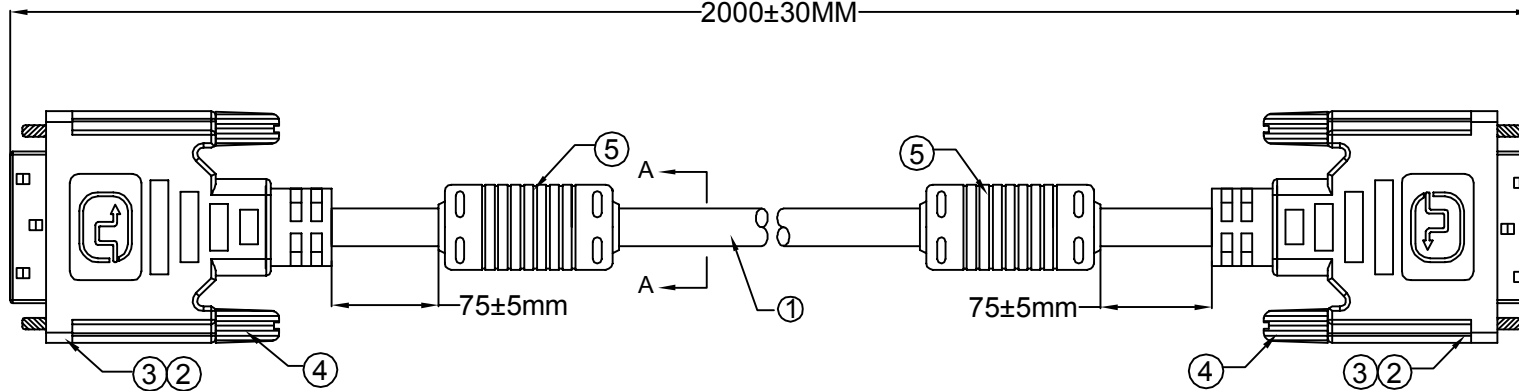
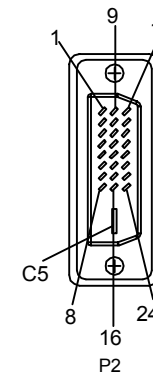
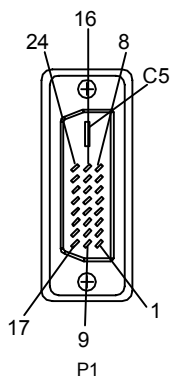

NOTES:

1. CABLE: UL 20276[30AWG(7/0.1BC)*1P +AL/MY]*7C+30AWG(7/0.1BC)*1P+30AWG(7/0.1BC)*3C
 +D30AWG(7/0.1BC)+AL/MY+B(65% COVERAGE ALM) OD=7.3±0.20mm JACKET COLOR: BLACK
 CABLE MUST PRINT: E***** AWM 20276 80°C 30V VW-1

2. CONNECTOR:

P1&P2: DVI (24+1)P/M, SOLDER, BLACK INSULATION, GOLD FLASH PLATED CONTACTS, NICKEL PLATED SHELL

3. HOOD: MOLDED TYPE, ABS, COLOR: BLACK.

4. THUMB SCREW: #4-40 UNC, MOLDED TYPE, PVC 45P, COLOR: BLACK

5. FERRITE CORE: (Ø17.5 X Ø9.5 X 28.5mm), MOLDED BLACK PVC.

6. ELECTRIC TEST:

- (1) 100% OPEN SHORT & MIS WIRE TEST.
- (2) CONTACT RESISTANCE 3 ohm Max .
- (3) INSULATION RESISTANCE 10M ohm Min .
- (4) HI-POT TEST: DC 300V/10ms

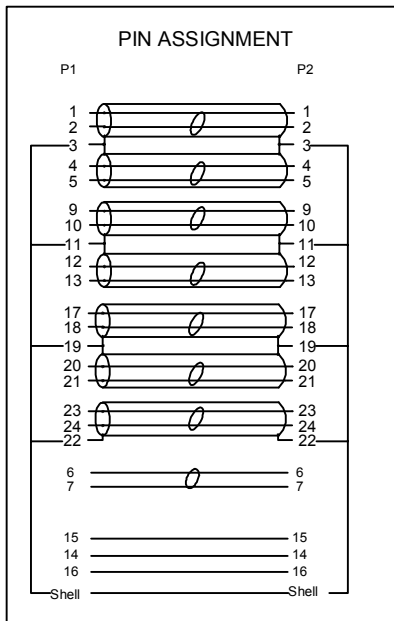

Cross Section:

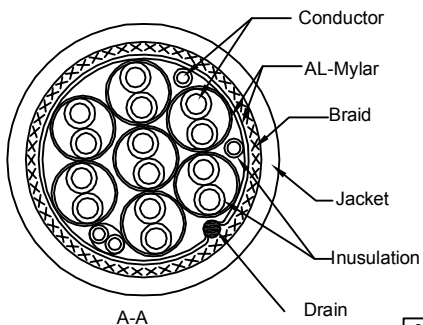

80496

	Date	Name	Part No.
Drawn by	Sep.17.2013	Sean	AK-320101-020-S
Checked by	Sep.17.2013	Joe	EAN:4016032298366
Approved by	Sep.17.2013	Andy	Title
ASSMANN Electronic GmbH			DVI (24+1)P/M - DVI (24+1)P/M CABLE
			Scale Unit

1

2

3

4

5

6

7

Package Details

RoHS Compliant

Signature	Revision History	Date	Rev.
Sean	For Bulk Production	Sep.17.2013	01

Single Cable

P/N	Cable Length	Rolling Size (Single Cable)	Polybag Type (Single Cable)	Bag Size (Single Cable)	Article Weight (Single Cable)
AK-320101-020-S	2m	mm max.	Ordinary Polybag (Heat Sealed)	*0.05mm	kg

Inner Packing Unit

P/N	Cable Length	Quantity (Inner Packing Unit)	Type (Inner Packing Unit)	Size (Inner Packing Unit)	Weight (Inner Packing Unit)
AK-320101-020-S	2m	10 pcs	Polybag (Heat Sealed)	*0.05mm	kg

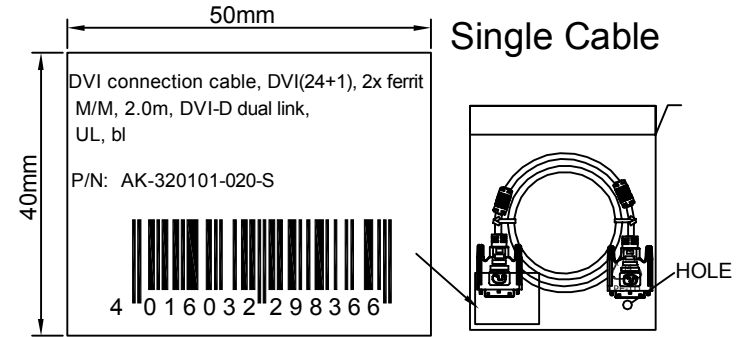

Inner Packing Unit

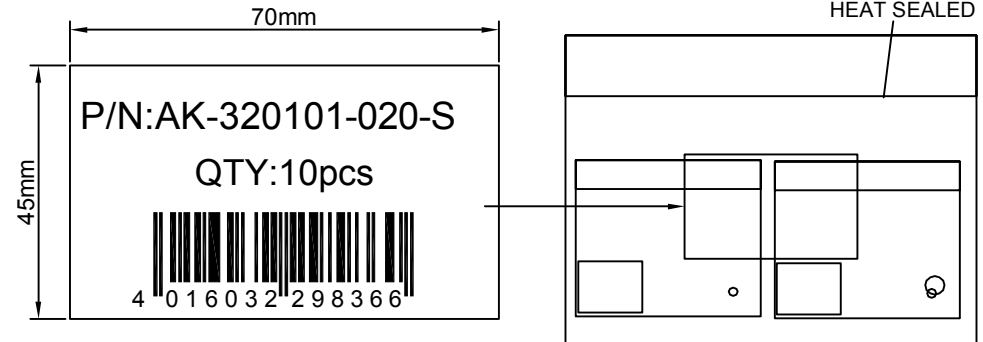

CARTON DETAILS

P/N	Cable Length	Quantity (Carton)	Measurement (Carton)	N.W. (Carton)	G.W. (Carton)
AK-320101-020-S	2m	pcs	cm	kg	kg

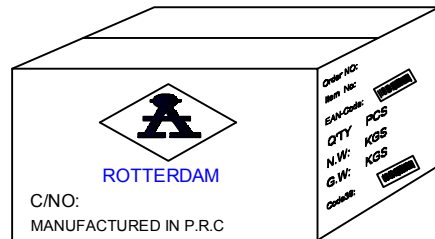

* "ROTTERDAM" is for Sea Freight shipment
 * "COLOGNE" is for Air Freight shipment
 * "LUDENSCHIED" is for Fedex or UPS shipment

	Date	Name	Part No.
Drawn by	Sep.17,2013	Sean	AK-320101-020-S
Checked by	Sep.17,2013	Joe	EAN:4016032298366
Approved by	Sep.17,2013	Andy	
ASSMANN Electronic GmbH			Title
			DVI (24+1)P/M - DVI (24+1)P/M CABLE
			Scale
	Unit	MM	2/2

80496