

Material:

- Insulator: L.C.P. UL 94V-0 rated
- Contact: Brass, t=0.25mm
- Contact plating: 5µ" selective gold on contact
- Shell: Brass, t=0.20mm
- Shell plating: Nickel
- Number of pins: 4
- Contact type: Female
- Insulator color: Black high temperature

Electrical:

- Current rating: 1A Max.
- Dielectric withstanding voltage: 500V(AC) for 1 min.
- Contact resistance: 30mW Max.
- Insulation resistance: 1000MW Min at DC 500V
- Total mating force: 3.57 Kgf Max.
- Total unmating force: 0.71 Kgf Min.
- Temperature range: -40°C~+85°C

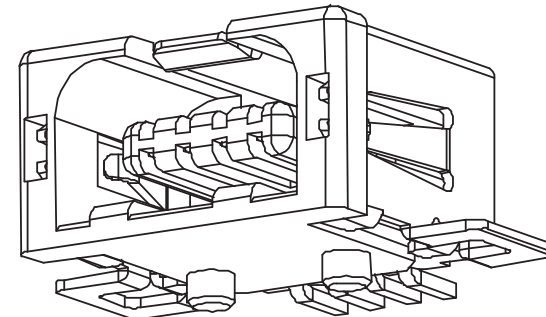
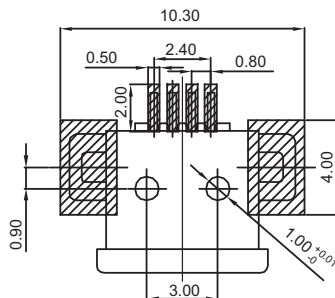
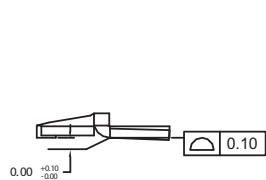
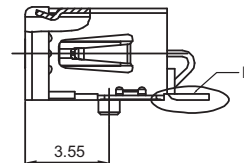
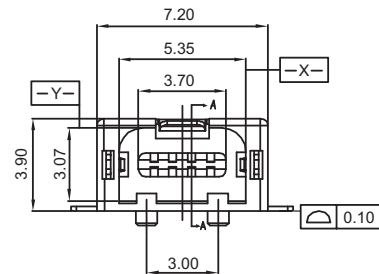
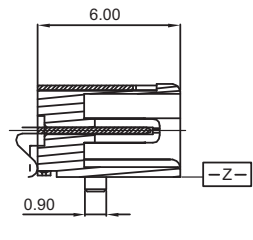

RECOMMENDED PCB LAYOUT

Scale	4:1					Date	Name	Title USB 1.1 Mini Connector H-Type SMT 4-poles for PCB Mount, B Female type ASSMANN WSW-No.
TOLERANCE						Drawn	Wilson	
X.	±0.38					Approved		A-USB-B-M4-H-R
X.X	±0.25							Drawing-No.
X.XX	±0.13							rev00
Size	A3							Replace
X.°	±3°							Sheet
X.X°	±1.0°	ⓐ						1/1
		Id.	Modification	Date	Name			

Unit: mm



1840 W. Drake Drive, Suite 101 • Tempe, AZ 85283
Toll Free: 1-877-277-6266 • Email: info@assmann.us