



THTS-1AA542006MZ

THTS

TEMPERATURE SENSORS

SICK
Sensor Intelligence.



Illustration may differ



Ordering information

| Type | Part no. |
|------------------|----------|
| THTS-1AA542006MZ | 6047614 |

Other models and accessories → www.sick.com/THTS

Detailed technical data

Features

| | |
|---|--|
| Measuring range | -50 °C +150 °C |
| Sensor element | Pt100, Pt1000 (for 4 mA ... 20 mA version) |
| Analog signal output and ohmic load R_A | 4 mA ... 20 mA, 2-wire ($R_A \leq (L^+ - 10 \text{ V}) / 0.023 \text{ A [Ohm]}$) |

Performance

| | |
|-----------------------------------|---|
| Accuracy of sensor element | Class A according to IEC 60751 ¹⁾ |
| Transmitter accuracy | ± 0,25 K |
| Transmitter linearity | ≤ ± 0.1 % of span |
| Response time | $t_{50} \leq 3,3 \text{ s}$ $t_{90} \leq 9,7 \text{ s}^{2)}$ |

¹⁾ Class B (measuring range -50 °C ... -30 °C).

²⁾ Depending on sensor configuration, according to IEC 60751.

Mechanics/electronics

| | |
|---|---|
| Process connection | Conical coupling (DIN 11851) DN 40 with union nut |
| Insertion length/diameter of probe | 200 mm / 6 mm |
| Wetted parts | Stainless steel 1.4435 / 316L, $R_a \leq 0.8 \mu\text{m}$ |
| Pressure resistance | Max. 40 bar at room temperature |
| Housing material | Stainless steel (CrNi) |
| Electrical connection | Round connector M12 x 1, 4-pin, IP 67 and IP 69 ¹⁾ |
| Supply voltage | 10 V DC ... 35 V DC |
| Maximum current consumption | Ca. 30 mA |
| Electrical safety | Protection class: III, dielectric strength: 500 V AC, Reverse polarity protection: L^+ to M |
| Protection class III | ✓ |
| CE-conformity | 2004/108/EC, EN 61326-2-3 |
| RoHS certificate | ✓ |
| Initialization time | Max. 4 s |

¹⁾ IP enclosure rating as per IEC 60529. The enclosure rating classes specified only apply while the device is connected with male cable connectors of the corresponding enclosure rating.

Ambient data

| | |
|--|---|
| Ambient temperature | -40 °C ... +85 °C |
| Storage and transport temperature | -40 °C ... +85 °C |
| Shock resistance | 50 g, 6ms (according to IEC 60068-2-27) |
| Relative humidity | 100 % ¹⁾ |

¹⁾ , Condensation allowed.

Classifications

| | |
|-----------------------|----------|
| ECl@ss 5.0 | 27200208 |
| ECl@ss 5.1.4 | 27200208 |
| ECl@ss 6.0 | 27200208 |
| ECl@ss 6.2 | 27200208 |
| ECl@ss 7.0 | 27200208 |
| ECl@ss 8.0 | 27200208 |
| ECl@ss 8.1 | 27200208 |
| ECl@ss 9.0 | 27200208 |
| ETIM 5.0 | EC001446 |
| ETIM 6.0 | EC001446 |
| UNSPSC 16.0901 | 41112211 |

Dimensional drawing (Dimensions in mm (inch))

Conical coupling (DIN 11851) with union nut

4 mA...20 mA,
up to 150 °C

4 mA...20 mA,
up to 250 °C

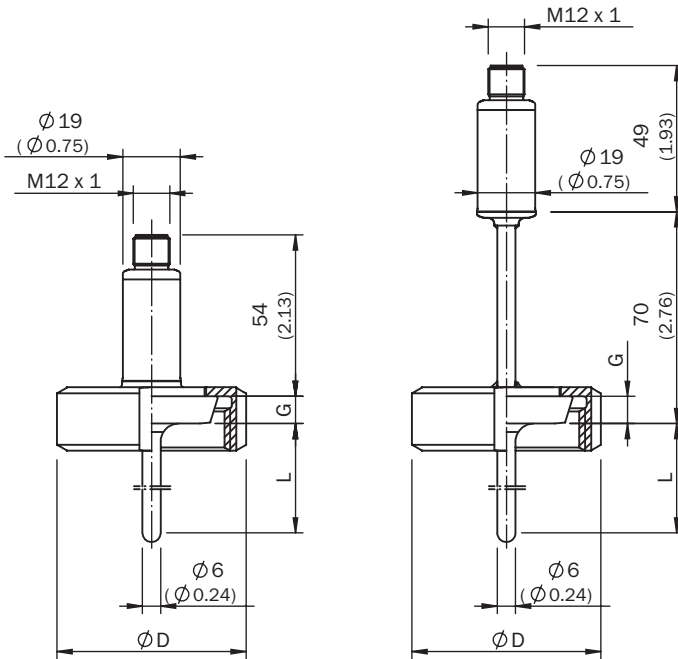

All dimensions in mm (inch)

| Design | | Ø D | G |
|------------------|-------|-------------|-----------|
| DIN 11851 | DN 20 | 54.0 (2.13) | 8 (0.31) |
| | DN 25 | 63.0 (2.48) | 10 (0.39) |
| | DN 32 | 70.0 (2.76) | 10 (0.39) |
| | DN 40 | 78.0 (3.07) | 10 (0.39) |
| | DN 50 | 92.0 (3.62) | 11 (0.43) |

Application



Connection type



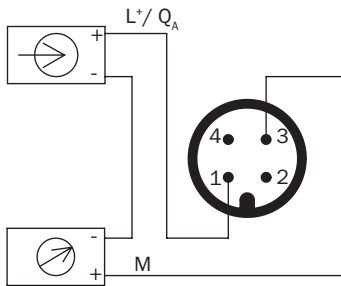





Plug M12 x 1, output signal 4 mA ... 20 mA



Recommended accessories

Other models and accessories → www.sick.com/THTS

| | Brief description | Type | Part no. |
|---|--|----------------|----------|
| Plug connectors and cables | | | |
|  | Head A: female connector, M12, 4-pin, straight Head B: cable Cable: PVC, unshielded, 2 m | DOL-1204-G02M | 6009382 |
|  | Head A: female connector, M12, 4-pin, straight Head B: cable Cable: drag chain use, PUR, halogen-free, unshielded, 2 m | DOL-1204-G02MC | 6025900 |
|  | Head A: female connector, M12, 4-pin, straight Head B: cable Cable: PVC, unshielded, 5 m | DOL-1204-G05M | 6009866 |
|  | Head A: female connector, M12, 4-pin, straight Head B: cable Cable: drag chain use, PUR, halogen-free, unshielded, 5 m | DOL-1204-G05MC | 6025901 |
|  | Head A: female connector, M12, 4-pin, straight Head B: cable Cable: PVC, unshielded, 10 m | DOL-1204-G10M | 6010543 |

| | Brief description | Type | Part no. |
|---|---|----------------|----------|
|  | Head A: female connector, M12, 4-pin, straight Head B: cable Cable: drag chain use, PUR, halogen-free, unshielded, 10 m | DOL-1204-G10MC | 6025902 |
|  | Head A: female connector, M12, 4-pin, straight Head B: cable Cable: PVC, unshielded, 15 m | DOL-1204-G15M | 6010753 |
|  | Head A: female connector, M12, 4-pin, angled Head B: cable Cable: PVC, unshielded, 2 m | DOL-1204-W02M | 6009383 |
|  | Head A: female connector, M12, 4-pin, angled Head B: cable Cable: drag chain use, PUR, halogen-free, unshielded, 2 m | DOL-1204-W02MC | 6025903 |
|  | Head A: female connector, M12, 4-pin, angled Head B: cable Cable: PVC, unshielded, 5 m | DOL-1204-W05M | 6009867 |
|  | Head A: female connector, M12, 4-pin, angled Head B: cable Cable: drag chain use, PUR, halogen-free, unshielded, 5 m | DOL-1204-W05MC | 6025904 |
|  | Head A: female connector, M12, 4-pin, angled Head B: cable Cable: PVC, unshielded, 10 m | DOL-1204-W10M | 6010541 |
|  | Head A: female connector, M12, 4-pin, angled Head B: cable Cable: drag chain use, PUR, halogen-free, unshielded, 10 m | DOL-1204-W10MC | 6025905 |

SICK AT A GLANCE

SICK is one of the leading manufacturers of intelligent sensors and sensor solutions for industrial applications. A unique range of products and services creates the perfect basis for controlling processes securely and efficiently, protecting individuals from accidents and preventing damage to the environment.

We have extensive experience in a wide range of industries and understand their processes and requirements. With intelligent sensors, we can deliver exactly what our customers need. In application centers in Europe, Asia and North America, system solutions are tested and optimized in accordance with customer specifications. All this makes us a reliable supplier and development partner.

Comprehensive services complete our offering: SICK LifeTime Services provide support throughout the machine life cycle and ensure safety and productivity.

For us, that is “Sensor Intelligence.”

WORLDWIDE PRESENCE:

Contacts and other locations –www.sick.com