

## N-channel 100 V, 0.02 $\Omega$ typ., 32 A STripFET™ F7 Power MOSFET in a TO-220 package

Datasheet - production data

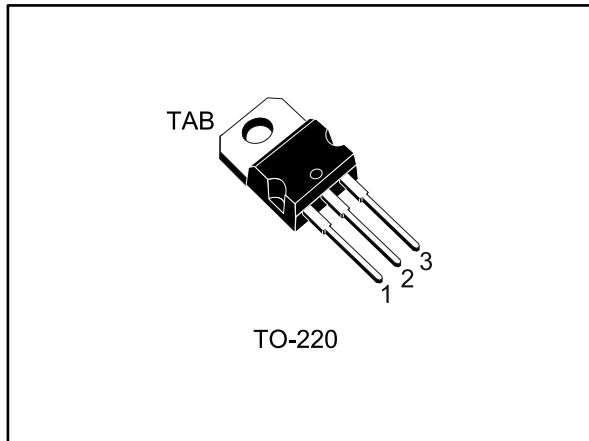

Figure 1: Internal schematic diagram

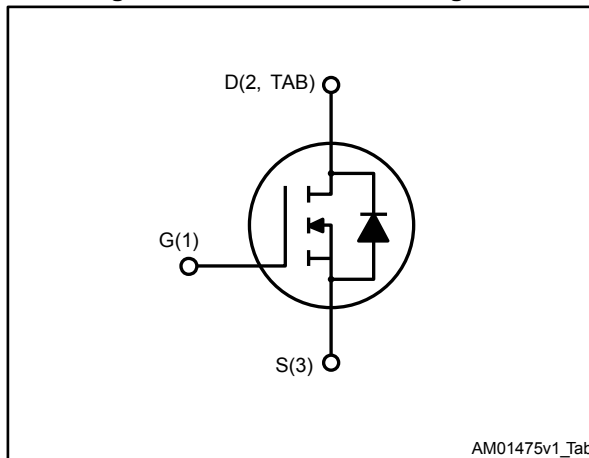

Table 1: Device summary

Order code	Marking	Package	Packing
STP30N10F7	30N10F7	TO-220	Tube

### Features

Order code	V <sub>DS</sub>	R <sub>DS(on)</sub> max.	I <sub>D</sub>	P <sub>TOT</sub>
STP30N10F7	100 V	0.024 $\Omega$	32 A	50 W

- Among the lowest R<sub>DS(on)</sub> on the market
- Excellent figure of merit (FOM)
- Low C<sub>rss</sub> / C<sub>iss</sub> ratio for EMI immunity
- High avalanche ruggedness

### Applications

- Switching applications

### Description

This N-channel Power MOSFET utilizes STripFET™ F7 technology with an enhanced trench gate structure that results in very low on-state resistance, while also reducing internal capacitance and gate charge for faster and more efficient switching.

---

## Contents

<b>1</b>	<b>Electrical ratings</b> .....	<b>3</b>
<b>2</b>	<b>Electrical characteristics</b> .....	<b>4</b>
	2.1 Electrical characteristics (curves).....	5
<b>3</b>	<b>Test circuits</b> .....	<b>8</b>
<b>4</b>	<b>Package information</b> .....	<b>9</b>
	4.1 TO-220 type A package information.....	10
<b>5</b>	<b>Revision history</b> .....	<b>12</b>

# 1 Electrical ratings

**Table 2: Absolute maximum ratings**

Symbol	Parameter	Value	Unit
$V_{DS}$	Drain-source voltage	100	V
$V_{GS}$	Gate source voltage	$\pm 20$	V
$I_D$	Drain current (continuous) at $T_C = 25\text{ }^\circ\text{C}$	32	A
$I_D$	Drain current (continuous) at $T_C = 100\text{ }^\circ\text{C}$	23	A
$I_{DM}^{(1)}$	Drain current (pulsed)	132	A
$P_{TOT}$	Total dissipation at $T_C = 25\text{ }^\circ\text{C}$	50	W
$T_J$	Operating junction temperature range	-55 to 175	$^\circ\text{C}$
$T_{stg}$	Storage temperature range		

**Notes:**

<sup>(1)</sup>Pulse width limited by safe operating area.

**Table 3: Thermal data**

Symbol	Parameter	Value	Unit
$R_{thj-case}$	Thermal resistance junction-case	3	$^\circ\text{C/W}$
$R_{thj-amb}$	Thermal resistance junction-ambient	62.5	$^\circ\text{C/W}$

## 2 Electrical characteristics

( $T_C = 25\text{ °C}$  unless otherwise specified)

**Table 4: On /off states**

Symbol	Parameter	Test conditions	Min.	Typ.	Max.	Unit
$V_{(BR)DSS}$	Drain-source breakdown voltage	$V_{GS} = 0\text{ V}$ , $I_D = 250\text{ }\mu\text{A}$	100			V
$I_{DSS}$	Zero gate voltage drain current	$V_{GS} = 0\text{ V}$ , $V_{DS} = 100\text{ V}$			1	$\mu\text{A}$
		$V_{GS} = 0\text{ V}$ , $V_{DS} = 100\text{ V}$ , $T_C = 125\text{ °C}$			100	$\mu\text{A}$
$I_{GSS}$	Gate-body leakage current	$V_{DS} = 0\text{ V}$ , $V_{GS} = +20\text{ V}$			100	nA
$V_{GS(th)}$	Gate threshold voltage	$V_{DS} = V_{GS}$ , $I_D = 250\text{ }\mu\text{A}$	2.5		4.5	V
$R_{DS(on)}$	Static drain-source on-resistance	$V_{GS} = 10\text{ V}$ , $I_D = 16\text{ A}$		0.02	0.024	$\Omega$

**Table 5: Dynamic**

Symbol	Parameter	Test conditions	Min.	Typ.	Max.	Unit
$C_{iss}$	Input capacitance	$V_{DS} = 50\text{ V}$ , $f = 1\text{ MHz}$ , $V_{GS} = 0\text{ V}$	-	1270	-	pF
$C_{oss}$	Output capacitance		-	290	-	pF
$C_{rss}$	Reverse transfer capacitance		-	24	-	pF
$Q_g$	Total gate charge	$V_{DD} = 50\text{ V}$ , $I_D = 32\text{ A}$ ,	-	19	-	nC
$Q_{gs}$	Gate-source charge	$V_{GS} = 10\text{ V}$	-	9	-	nC
$Q_{gd}$	Gate-drain charge	(see <a href="#">Figure 14: "Test circuit for gate charge behavior"</a> )	-	4.5	-	nC

**Table 6: Switching times**

Symbol	Parameter	Test conditions	Min.	Typ.	Max.	Unit
$t_{d(on)}$	Turn-on delay time	$V_{DD} = 50\text{ V}$ , $I_D = 16\text{ A}$ , $R_G = 4.7\text{ }\Omega$ , $V_{GS} = 10\text{ V}$ (see <a href="#">Figure 13: "Test circuit for resistive load switching times"</a> )	-	12	-	ns
$t_r$	Rise time		-	17.5	-	ns
$t_{d(off)}$	Turn-off delay time		-	22	-	ns
$t_f$	Fall time		-	5.6	-	ns

Table 7: Source-drain diode

Symbol	Parameter	Test conditions	Min.	Typ.	Max.	Unit
$V_{SD}^{(1)}$	Forward on voltage	$I_{SD} = 32\text{ A}$ , $V_{GS} = 0\text{ V}$	-		1.1	V
$t_{rr}$	Reverse recovery time	$I_{SD} = 32\text{ A}$ , $di/dt = 100\text{ A}/\mu\text{s}$ $V_{DD} = 80\text{ V}$ , $T_J = 150\text{ }^\circ\text{C}$ , <i>Figure 15: "Test circuit for inductive load switching and diode recovery times"</i>	-	41		ns
$Q_{rr}$	Reverse recovery charge		-	47		nC
$I_{RRM}$	Reverse recovery current		-	2.3		A

Notes:

(1) Pulsed: pulse duration = 300  $\mu\text{s}$ , duty cycle 1.5%.

## 2.1 Electrical characteristics (curves)

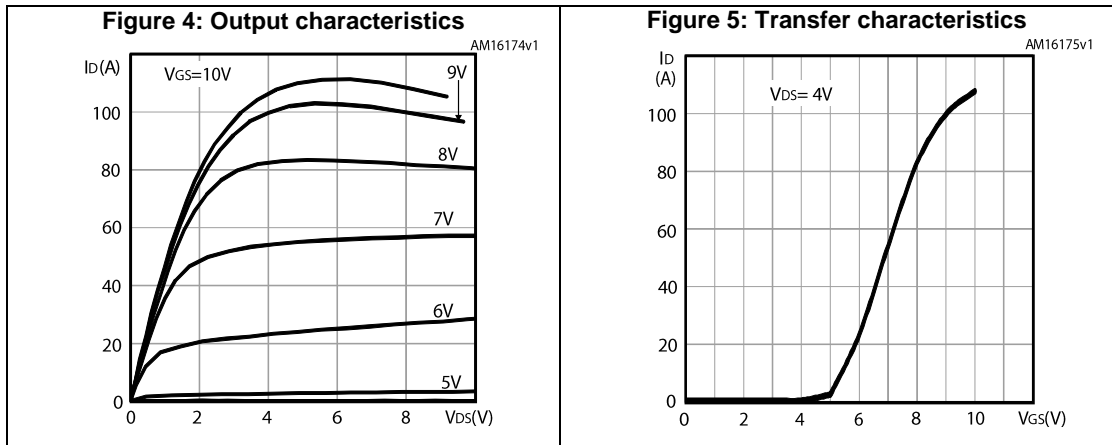
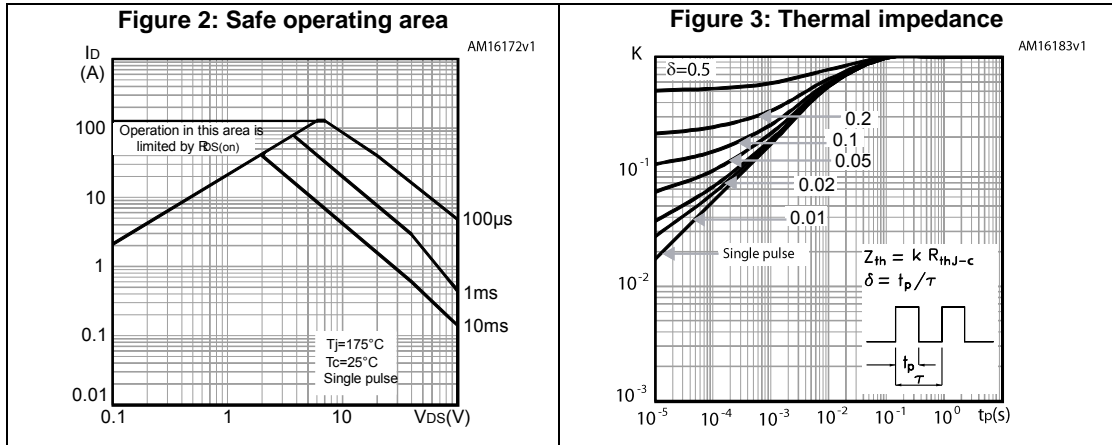

Figure 6: Gate charge vs gate-source voltage

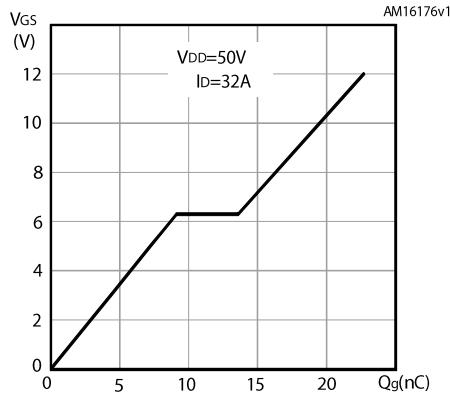

Figure 7: Static drain-source on-resistance

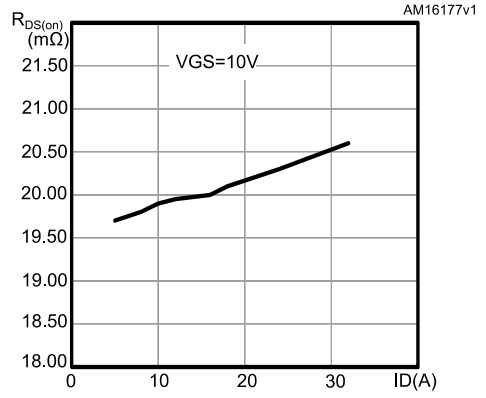

Figure 8: Capacitance variations

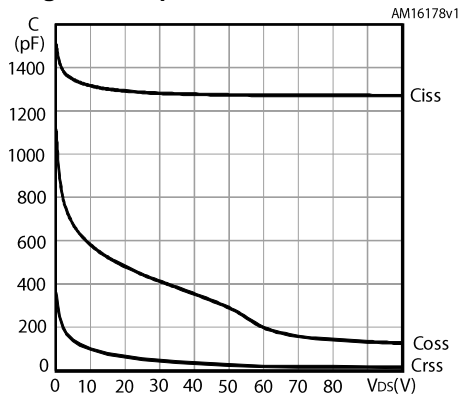

Figure 9: Normalized gate threshold voltage vs temperature

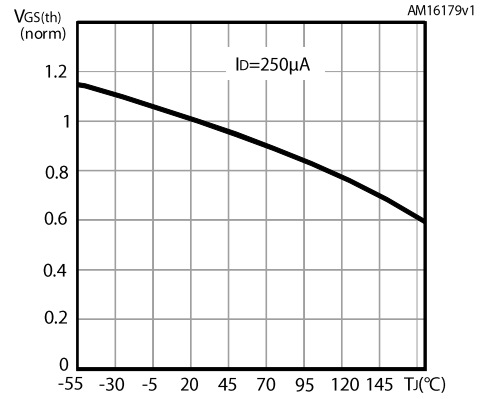

Figure 10: Normalized on-resistance vs temperature

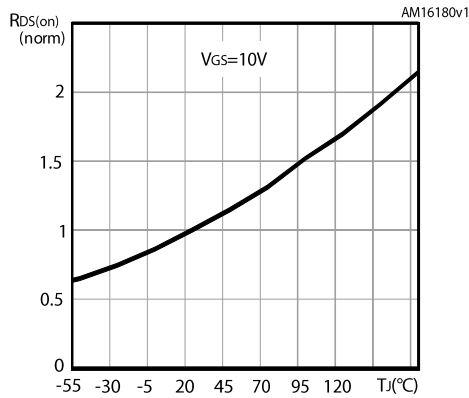
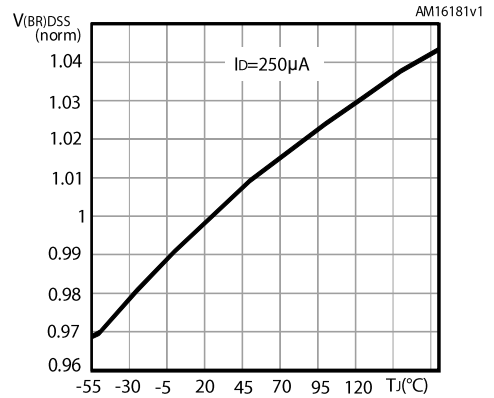
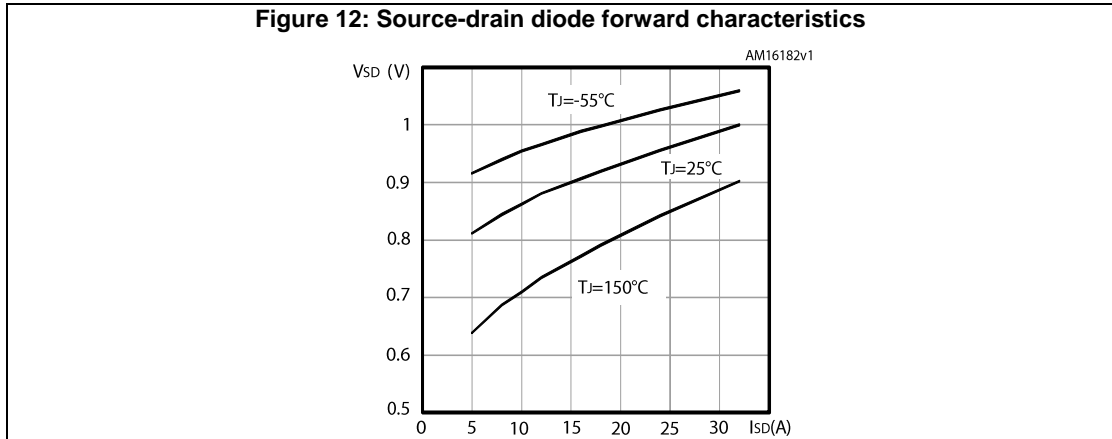

Figure 11: Normalized V(BR)DSS vs temperature



essaggio

Figure 12: Source-drain diode forward characteristics



### 3 Test circuits

**Figure 13: Test circuit for resistive load switching times**

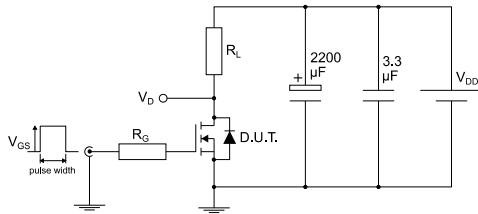

AM01468v1

**Figure 14: Test circuit for gate charge behavior**

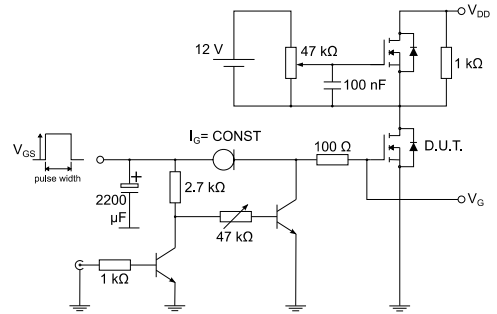

AM01469v1

**Figure 15: Test circuit for inductive load switching and diode recovery times**

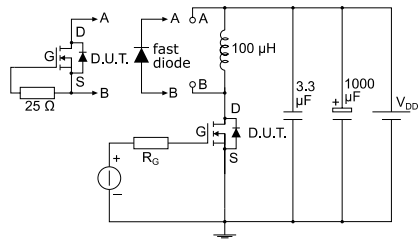

AM01470v1

**Figure 16: Unclamped inductive load test circuit**

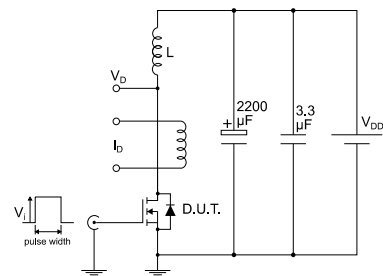

AM01471v1

**Figure 17: Unclamped inductive waveform**

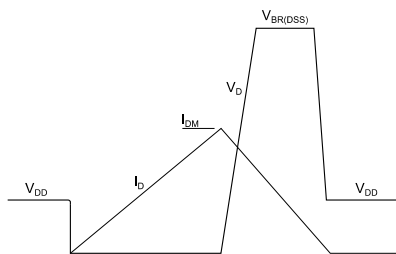

AM01472v1

**Figure 18: Switching time waveform**

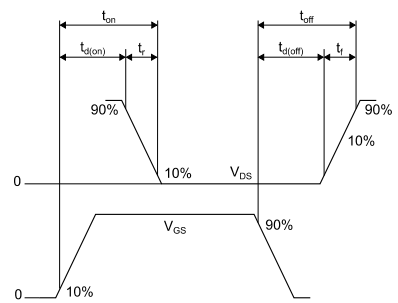

AM01473v1



## 4 Package information

In order to meet environmental requirements, ST offers these devices in different grades of ECOPACK<sup>®</sup> packages, depending on their level of environmental compliance. ECOPACK<sup>®</sup> specifications, grade definitions and product status are available at: [www.st.com](http://www.st.com). ECOPACK<sup>®</sup> is an ST trademark.

### 4.1 TO-220 type A package information

Figure 19: TO-220 type A package outline

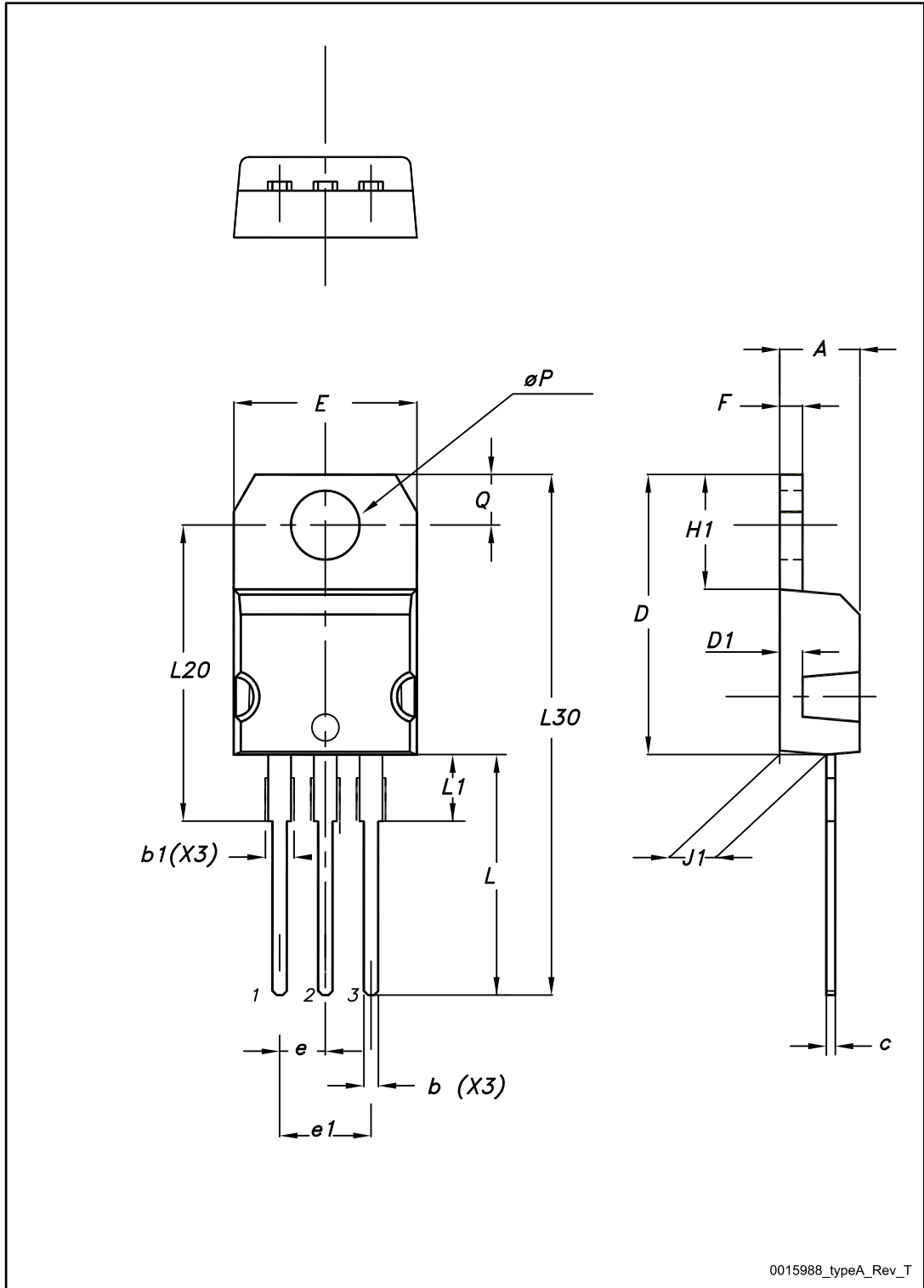

0015988\_typeA\_Rev\_T

Table 8: TO-220 type A mechanical data

Dim.	mm		
	Min.	Typ.	Max.
A	4.40		4.60
b	0.61		0.88
b1	1.14		1.70
c	0.48		0.70
D	15.25		15.75
D1		1.27	
E	10		10.40
e	2.40		2.70
e1	4.95		5.15
F	1.23		1.32
H1	6.20		6.60
J1	2.40		2.72
L	13		14
L1	3.50		3.93
L20		16.40	
L30		28.90	
øP	3.75		3.85
Q	2.65		2.95

## 5 Revision history

Table 9: Document revision history

Date	Revision	Changes
01-Feb-2016	1	First release.

**IMPORTANT NOTICE – PLEASE READ CAREFULLY**

STMicroelectronics NV and its subsidiaries ("ST") reserve the right to make changes, corrections, enhancements, modifications, and improvements to ST products and/or to this document at any time without notice. Purchasers should obtain the latest relevant information on ST products before placing orders. ST products are sold pursuant to ST's terms and conditions of sale in place at the time of order acknowledgement.

Purchasers are solely responsible for the choice, selection, and use of ST products and ST assumes no liability for application assistance or the design of Purchasers' products.

No license, express or implied, to any intellectual property right is granted by ST herein.

Resale of ST products with provisions different from the information set forth herein shall void any warranty granted by ST for such product.

ST and the ST logo are trademarks of ST. All other product or service names are the property of their respective owners.

Information in this document supersedes and replaces information previously supplied in any prior versions of this document.

© 2016 STMicroelectronics – All rights reserved