

V_{DS}	100	V
$V_{GS\ max}$	± 20	V
$R_{DS(on)\ max}$ (@ $V_{GS} = 10V$)	195	mΩ
$Q_g\ typ$	4.2	nC
I_D (@ $T_{c(Bottom)} = 25^\circ C$)	3.4 Ⓣ	A

HEXFET® Power MOSFET

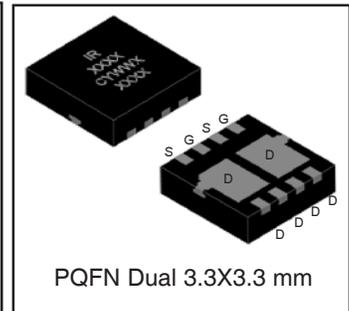
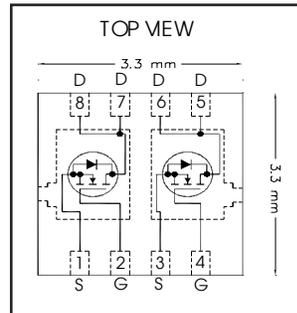

Applications

- DC-DC Primary Switch
- 48V Battery Monitoring

Features and Benefits

Features

Low $R_{DS(on)}$ (<195mΩ)
Low Thermal Resistance to PCB (< 12°C/W)
Low Profile (<1.2mm)
Industry-Standard Pinout
Compatible with Existing Surface Mount Techniques
RoHS Compliant Containing no Lead, no Bromide and no Halogen
MSL1, Industrial Qualification

results in
⇒

Benefits

Lower Conduction Losses
Enable better thermal dissipation
Increased Power Density
Multi-Vendor Compatibility
Easier Manufacturing
Environmentally Friendlier
Increased Reliability

Orderable part number	Package Type	Standard Pack		Note
		Form	Quantity	
IRFHM792TRPBF	PQFN Dual 3.3mm x 3.3mm	Tape and Reel	4000	
IRFHM792TR2PBF	PQFN Dual 3.3mm x 3.3mm	Tape and Reel	400	EOL notice # 259

Absolute Maximum Ratings

	Parameter	Max.	Units
V_{DS}	Drain-to-Source Voltage	100	V
V_{GS}	Gate-to-Source Voltage	± 20	
$I_D @ T_A = 25^\circ C$	Continuous Drain Current, $V_{GS} @ 10V$	2.3	A
$I_D @ T_A = 70^\circ C$	Continuous Drain Current, $V_{GS} @ 10V$	1.8	
$I_D @ T_{c(Bottom)} = 25^\circ C$	Continuous Drain Current, $V_{GS} @ 10V$	4.8 Ⓣ	
$I_D @ T_{c(Bottom)} = 100^\circ C$	Continuous Drain Current, $V_{GS} @ 10V$	3.1	
$I_D @ T_C = 25^\circ C$	Continuous Drain Current, $V_{GS} @ 10V$ (Wirebond Limited)	3.4 Ⓣ	
I_{DM}	Pulsed Drain Current Ⓣ	14	
$P_D @ T_A = 25^\circ C$	Power Dissipation Ⓣ	2.3	W
$P_D @ T_{c(Bottom)} = 25^\circ C$	Power Dissipation Ⓣ	10.4	
	Linear Derating Factor Ⓣ	0.018	W/°C
T_J	Operating Junction and	-55 to + 150	°C
T_{STG}	Storage Temperature Range		

Notes Ⓣ through Ⓣ are on page 9

Static @ T_J = 25°C (unless otherwise specified)

	Parameter	Min.	Typ.	Max.	Units	Conditions
BV _{DSS}	Drain-to-Source Breakdown Voltage	100	—	—	V	V _{GS} = 0V, I _D = 250μA
ΔBV _{DSS} /ΔT _J	Breakdown Voltage Temp. Coefficient	—	0.11	—	V/°C	Reference to 25°C, I _D = 1.0mA
R _{DS(on)}	Static Drain-to-Source On-Resistance	—	164	195	mΩ	V _{GS} = 10V, I _D = 2.9A ③
V _{GS(th)}	Gate Threshold Voltage	2.0	3.0	4.0	V	V _{DS} = V _{GS} , I _D = 10μA
ΔV _{GS(th)}	Gate Threshold Voltage Coefficient	—	-8.2	—	mV/°C	
I _{DSS}	Drain-to-Source Leakage Current	—	—	20	μA	V _{DS} = 100V, V _{GS} = 0V
		—	—	250	mA	V _{DS} = 100V, V _{GS} = 0V, T _J = 125°C
I _{GSS}	Gate-to-Source Forward Leakage	—	—	100	nA	V _{GS} = 20V
	Gate-to-Source Reverse Leakage	—	—	-100		V _{GS} = -20V
g _{fs}	Forward Transconductance	3.5	—	—	S	V _{DS} = 50V, I _D = 2.9A
Q _g	Total Gate Charge	—	4.2	6.3	nC	V _{DS} = 50V V _{GS} = 10V I _D = 2.9A
Q _{gs1}	Pre-V _{th} Gate-to-Source Charge	—	0.7	—		
Q _{gs2}	Post-V _{th} Gate-to-Source Charge	—	0.3	—		
Q _{gd}	Gate-to-Drain Charge	—	1.3	—		
Q _{godr}	Gate Charge Overdrive	—	1.9	—		
Q _{sw}	Switch Charge (Q _{gs2} + Q _{gd})	—	1.6	—		
Q _{oss}	Output Charge	—	6.7	—	nC	V _{DS} = 16V, V _{GS} = 0V
R _G	Gate Resistance	—	1.6	—	Ω	
t _{d(on)}	Turn-On Delay Time	—	3.4	—	ns	V _{DD} = 50V, V _{GS} = 10V I _D = 2.9A R _G = 1.8Ω
t _r	Rise Time	—	4.7	—		
t _{d(off)}	Turn-Off Delay Time	—	5.2	—		
t _f	Fall Time	—	2.6	—		
C _{iss}	Input Capacitance	—	251	—	pF	V _{GS} = 0V V _{DS} = 25V f = 1.0MHz
C _{oss}	Output Capacitance	—	31	—		
C _{rss}	Reverse Transfer Capacitance	—	13	—		

Avalanche Characteristics

	Parameter	Typ.	Max.	Units
E _{AS}	Single Pulse Avalanche Energy ②	—	10.2	mJ
I _{AR}	Avalanche Current ①	—	2.9	A

Diode Characteristics

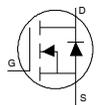
	Parameter	Min.	Typ.	Max.	Units	Conditions
I _S	Continuous Source Current (Body Diode)	—	—	3.4⑥	A	MOSFET symbol showing the integral reverse p-n junction diode. 
I _{SM}	Pulsed Source Current (Body Diode) ①	—	—	14		
V _{SD}	Diode Forward Voltage	—	—	1.3	V	T _J = 25°C, I _S = 2.9A, V _{GS} = 0V ③
t _{rr}	Reverse Recovery Time	—	15	23	ns	T _J = 25°C, I _F = 2.9A, V _{DD} = 50V
Q _{rr}	Reverse Recovery Charge	—	45	68	nC	di/dt = 500A/μs ③
t _{on}	Forward Turn-On Time	Time is dominated by parasitic Inductance				

Thermal Resistance

	Parameter	Typ.	Max.	Units
R _{θJC} (Bottom)	Junction-to-Case ④	—	12	°C/W
R _{θJC} (Top)	Junction-to-Case ④	—	85	
R _{θJA}	Junction-to-Ambient ⑤	—	55	
R _{θJA} (<10s)	Junction-to-Ambient ⑤	—	38	

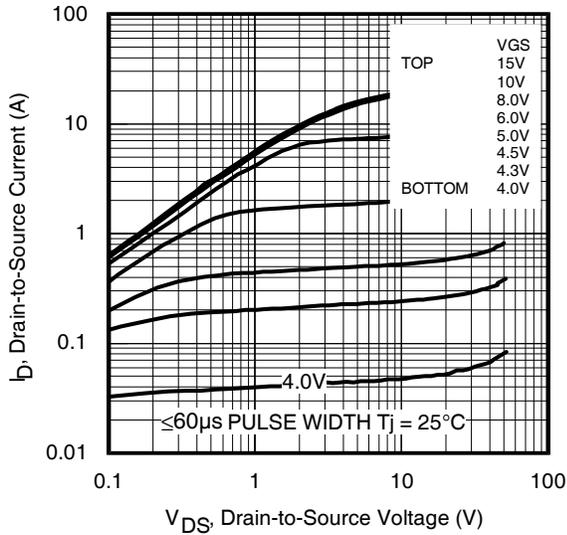
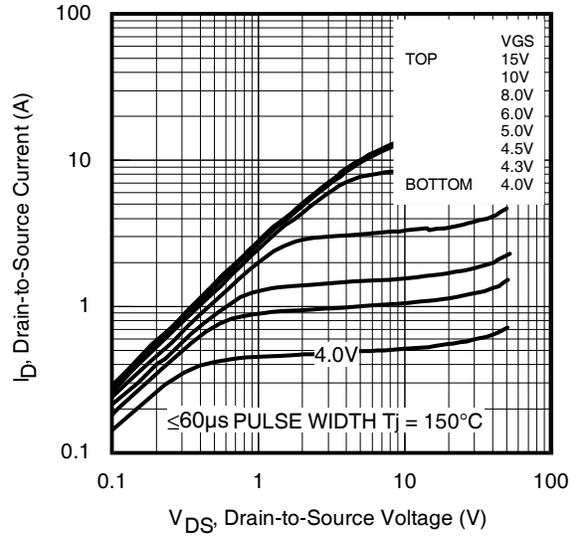
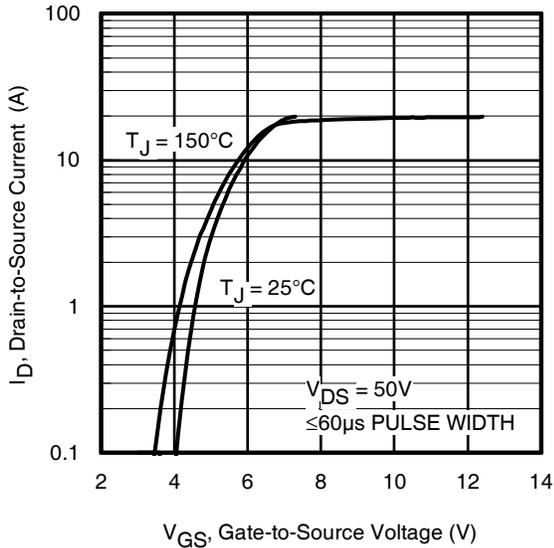
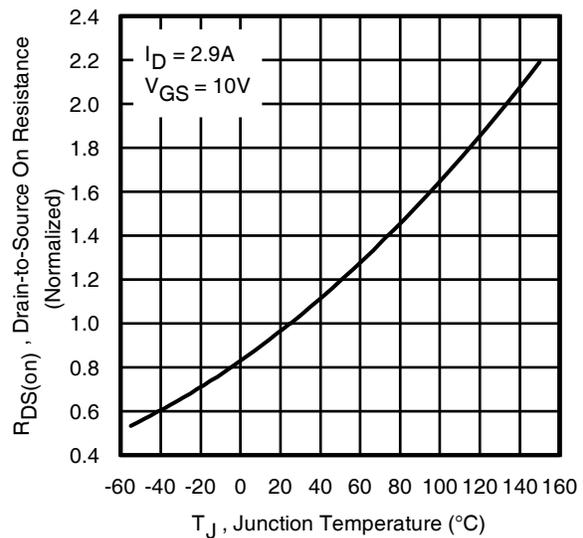
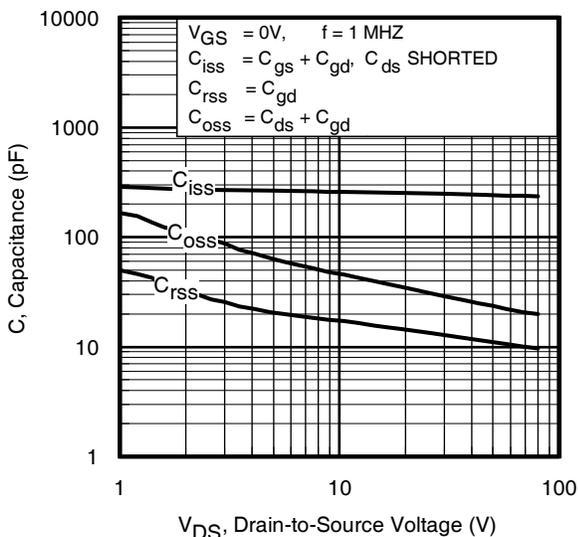
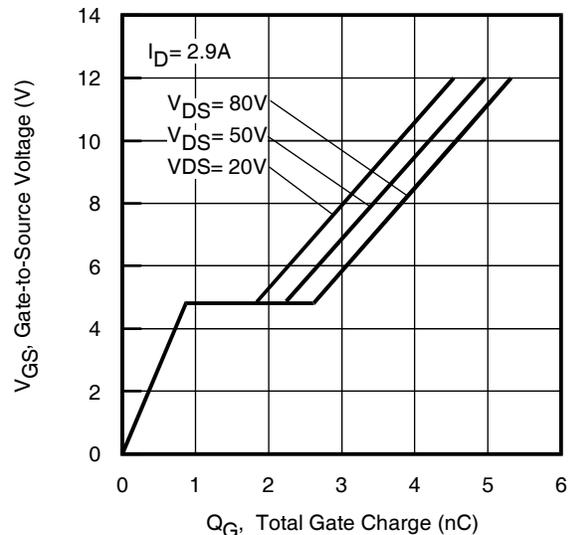
Fig 1. Typical Output Characteristics

Fig 2. Typical Output Characteristics

Fig 3. Typical Transfer Characteristics

Fig 4. Normalized On-Resistance vs. Temperature

Fig 5. Typical Capacitance vs. Drain-to-Source Voltage

Fig 6. Typical Gate Charge vs. Gate-to-Source Voltage

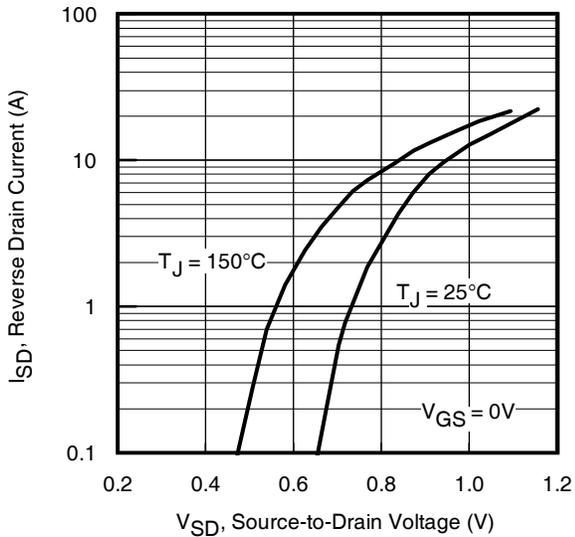

Fig 7. Typical Source-Drain Diode Forward Voltage

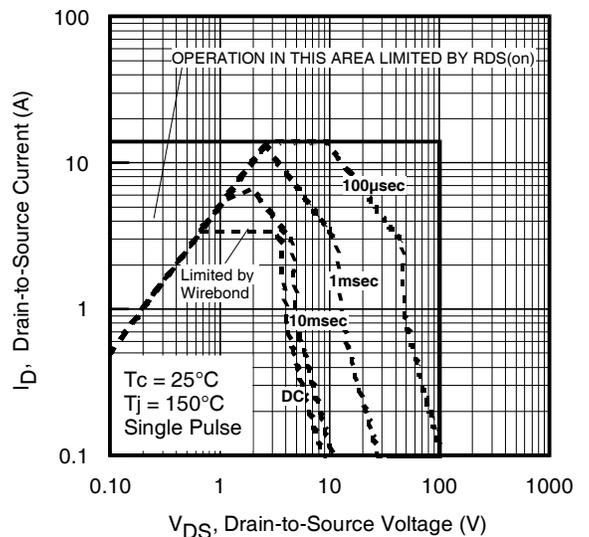

Fig 8. Maximum Safe Operating Area

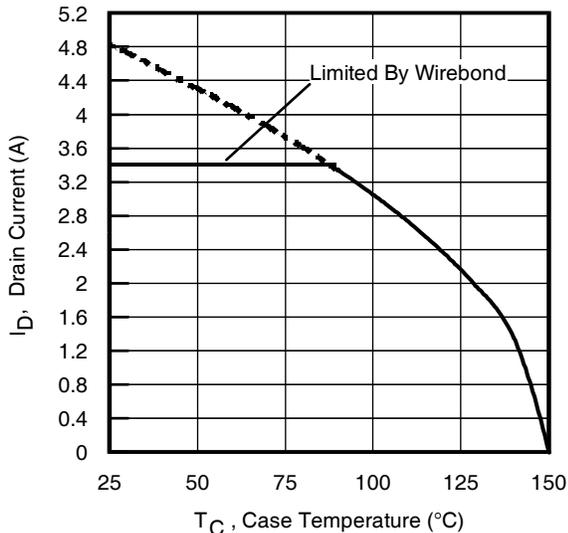

Fig 9. Maximum Drain Current vs. Case (Bottom) Temperature

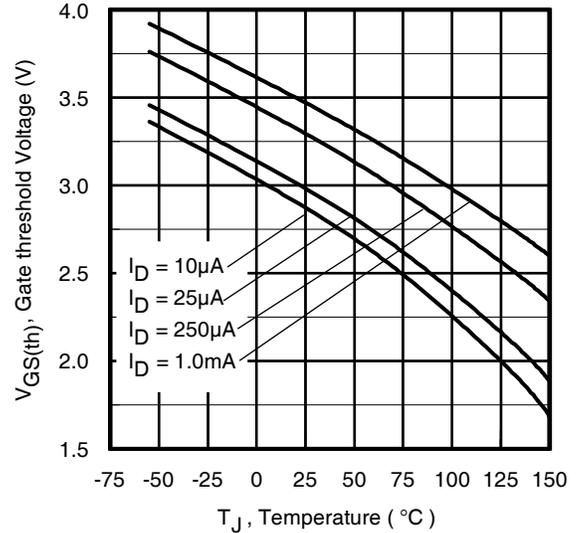

Fig 10. Threshold Voltage vs. Temperature

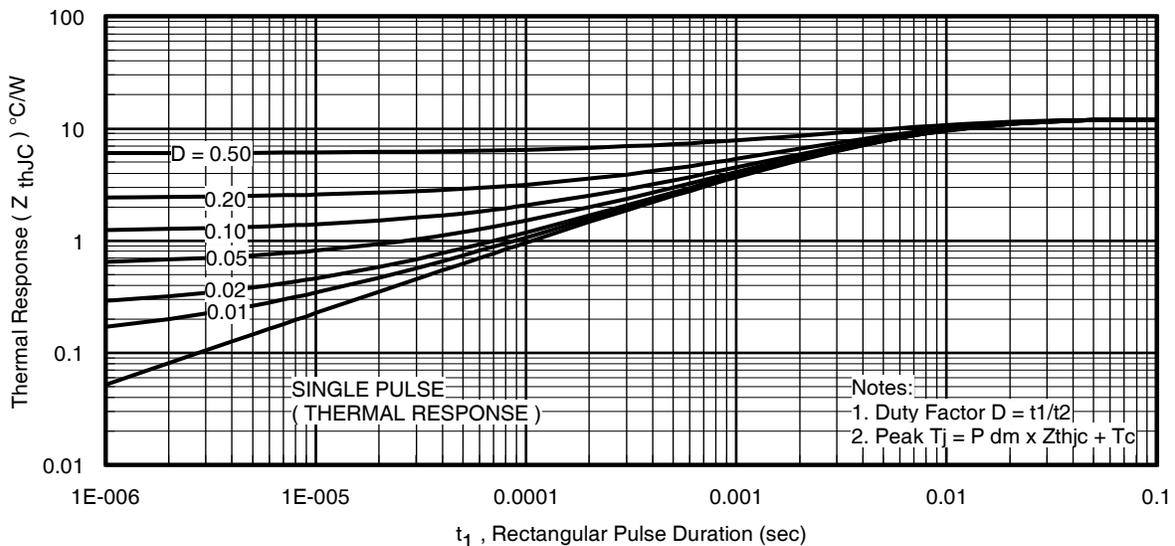

Fig 11. Maximum Effective Transient Thermal Impedance, Junction-to-Case (Bottom)

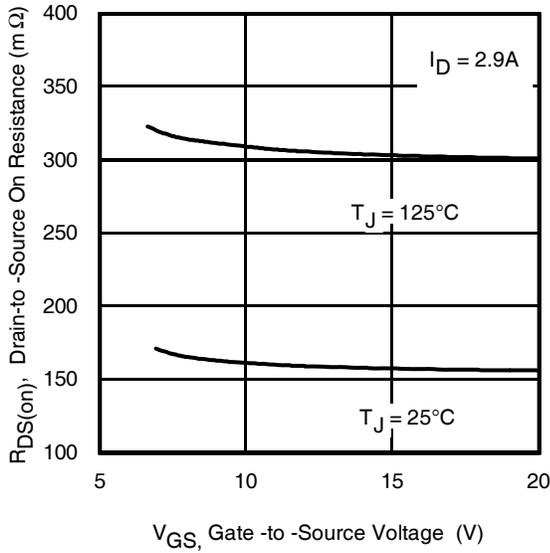

Fig 12. On-Resistance vs. Gate Voltage

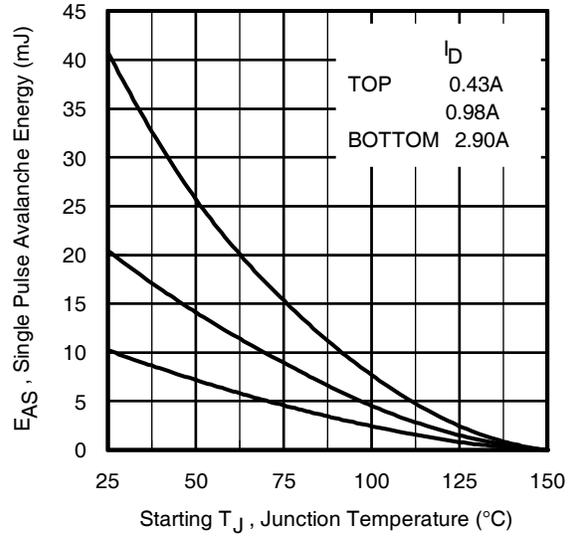

Fig 13. Maximum Avalanche Energy vs. Drain Current

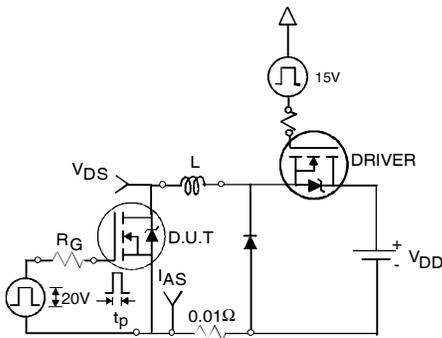

Fig 14a. Unclamped Inductive Test Circuit

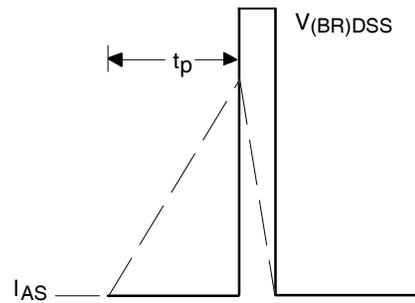

Fig 14b. Unclamped Inductive Waveforms

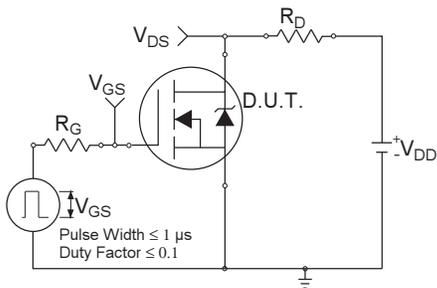

Fig 15a. Switching Time Test Circuit

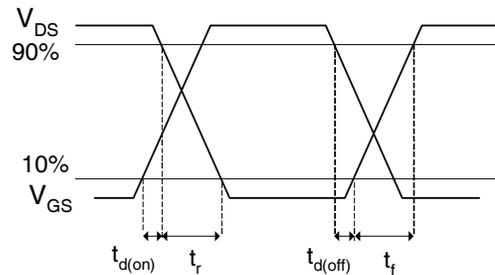

Fig 15b. Switching Time Waveforms

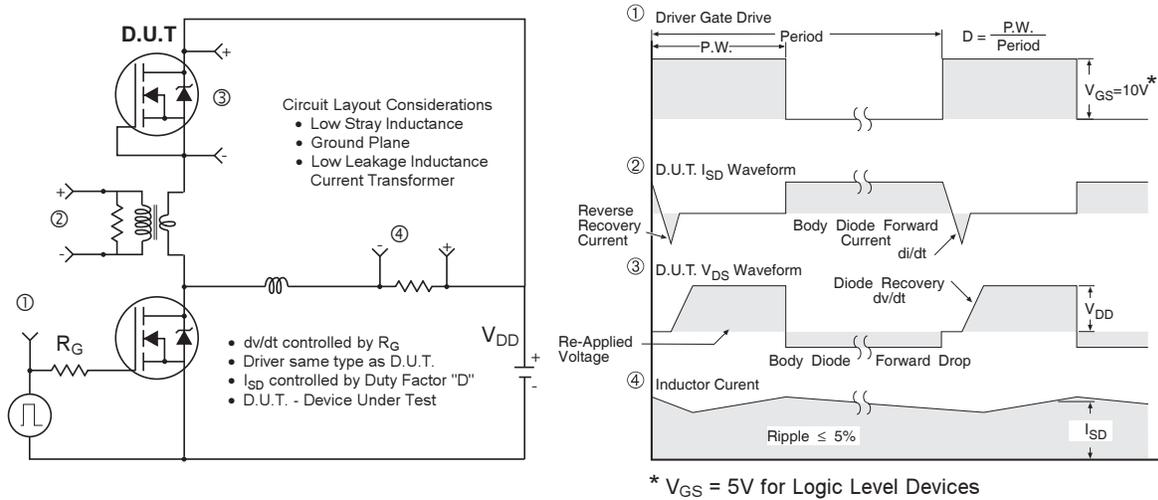

Fig 16. Peak Diode Recovery dv/dt Test Circuit for N-Channel HEXFET[®] Power MOSFETs

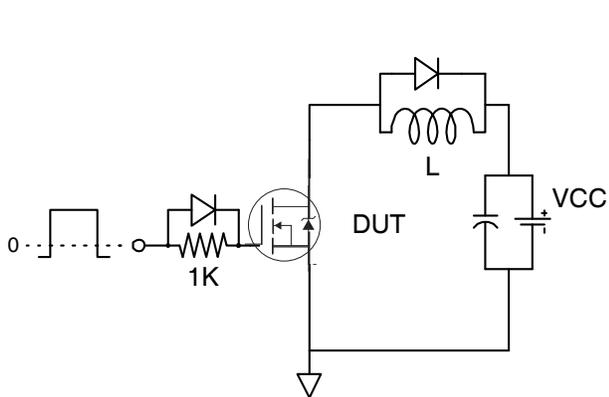

Fig 17. Gate Charge Test Circuit

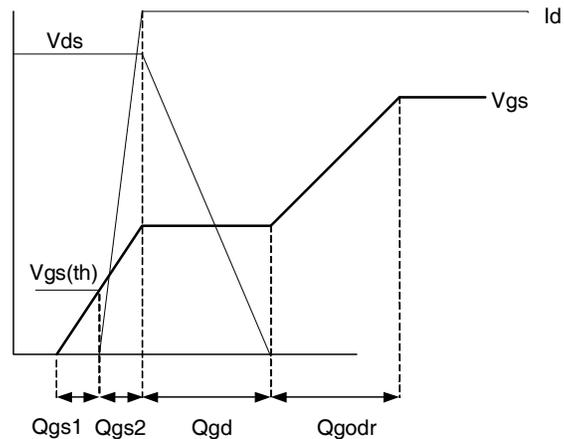
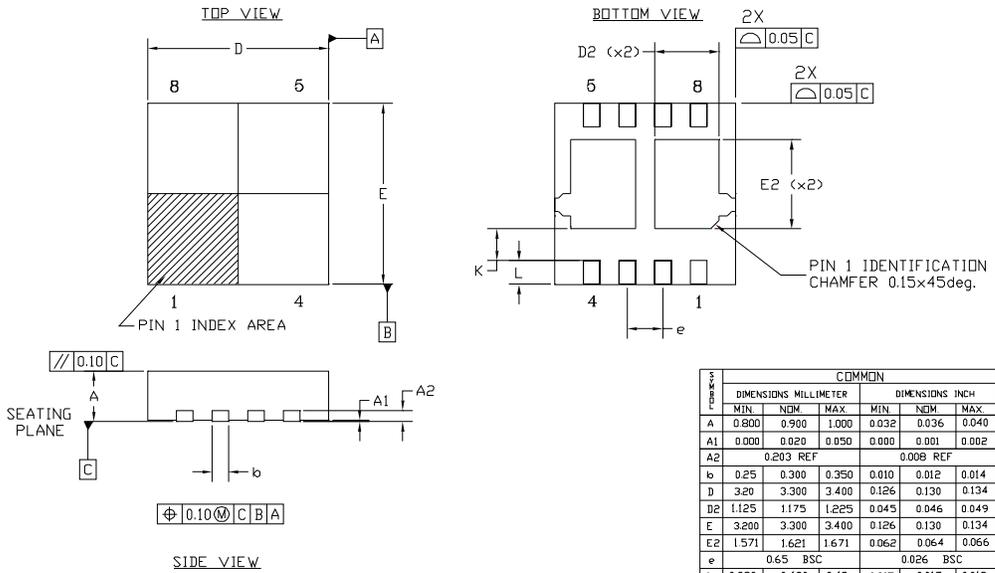

Fig 18. Gate Charge Waveform

PQFN Dual 3.3x3.3 Package Details



- NOTES :
1. DIMENSION AND TOLERANCING CONFORM TO ASME Y14.5M-1994.
 2. CONTROLLING DIMENSIONS : MILLIMETER. CONVERTED INCH DIMENSION ARE NOT NECESSARILY EXACT.
 3. DIMENSION b APPLIES TO METALLIZED TERMINAL AND IS MEASURED BETWEEN 0.15 AND 0.30 mm FROM TERMINAL TIP.

For footprint and stencil design recommendations, please refer to application note AN-1154 at <http://www.irf.com/technical-info/appnotes/an-1154.pdf>

PQFN Dual 3.3x3.3 Part Marking

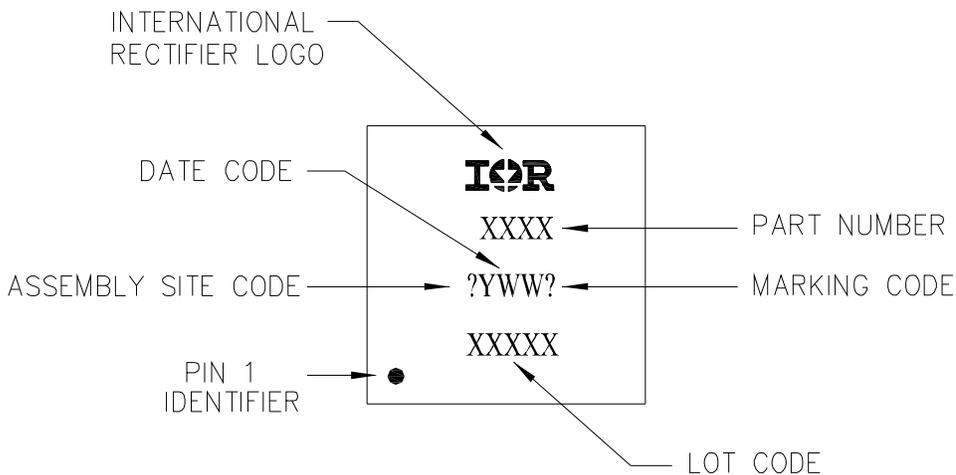

Note: For the most current drawing please refer to IR website at: <http://www.irf.com/package/>

PQFN Dual 3.3x3.3 Tape and Reel

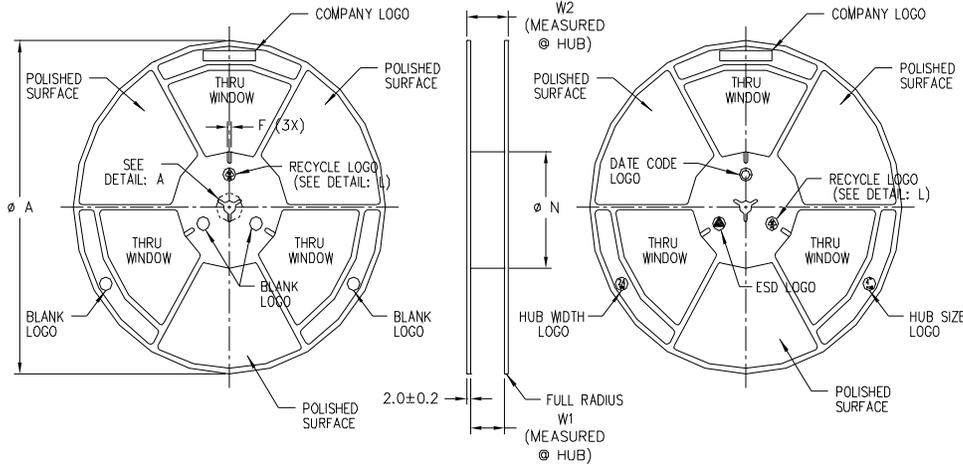

NOTES:

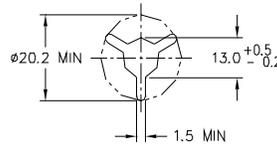
1. GENERIC PRODUCT.
2. FOR PRODUCT DRAWING ONLY.
3. SUNBLAST ALL SURFACE UNLESS OTHERWISE STATED.
4. MOLD 2

DETAIL: L

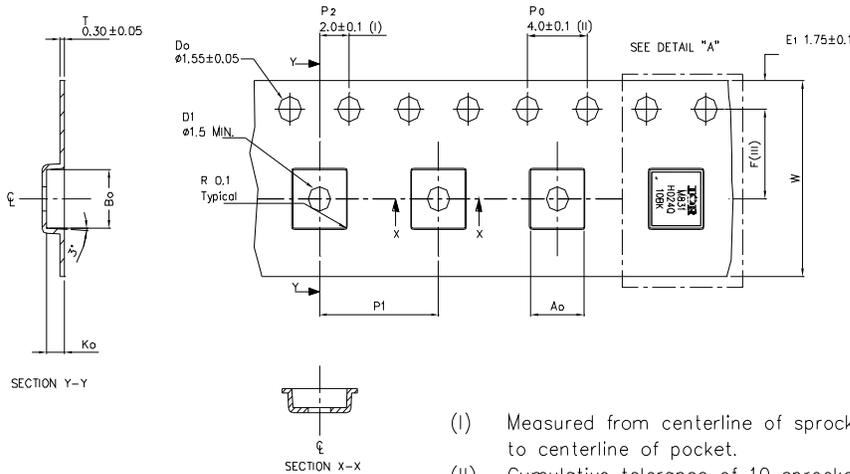

LEGEND	SURFACE	RESISTIVITY	COLOUR
A	BELOW 10^{12}	ANTISTATIC	ALL TYPES
B	10^6 TO 10^{11}	STATIC DISSIPATIVE	BLACK ONLY
C	10^5 & BELOW 10^5	CONDUCTIVE (GENERIC)	BLACK ONLY
D	10^5 TO 10^9	CONDUCTIVE (CUSTOM)	BLACK ONLY
E	BELOW 10^{12}	COATED ANTISTATIC	ALL COLOR

TAPE WIDTH	PRODUCT SPECIFICATION				
	$\phi A \pm 2.0$	$\phi N \pm 2.0$	W1	W2 (MAX)	E (MIN)
08MM	330	100	$8.4^{+1.5}_{-0.0}$	14.4	2.5
12MM	330	100	$12.4^{+2.0}_{-0.0}$	18.4	2.5
16MM	330	100	$16.4^{+2.0}_{-0.0}$	22.4	2.5
24MM	330	100	$24.4^{+2.0}_{-0.0}$	30.4	2.5
32MM	330	100	$32.4^{+2.0}_{-0.0}$	38.4	2.5

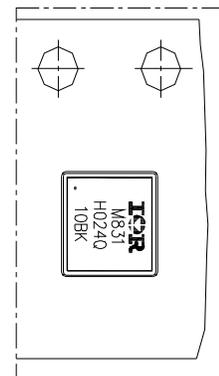

Ao	3.60 +/- 0.1
Bo	3.60 +/- 0.1
Ko	1.20 +/- 0.1
F	5.50 +/- 0.1
P1	8.00 +/- 0.1
W	12.00 +/- 0.3

- (I) Measured from centerline of sprocket hole to centerline of pocket.
- (II) Cumulative tolerance of 10 sprocket holes is ± 0.20 .
- (III) Measured from centerline of sprocket hole to centerline of pocket.
- (IV) Other material available.
- (V) Typical SR of form tape Max 10^9 OHM/SQ

DETAIL "A"

Note: For the most current drawing please refer to IR website at: <http://www.irf.com/package/>

Qualification information[†]

Qualification level	Industrial ^{††} (per JEDEC JESD47F ^{†††} guidelines)	
Moisture Sensitivity Level	PQFN Dual 3.3mm x 3.3mm	MSL1 (per JEDEC J-STD-020D ^{†††})
RoHS compliant	Yes	

† Qualification standards can be found at International Rectifier's web site
<http://www.irf.com/product-info/reliability>

†† Higher qualification ratings may be available should the user have such requirements.
 Please contact your International Rectifier sales representative for further information:
<http://www.irf.com/whoto-call/salesrep/>

††† Applicable version of JEDEC standard at the time of product release.

Notes:

- ① Repetitive rating; pulse width limited by max. junction temperature.
- ② Starting $T_J = 25^\circ\text{C}$, $L = 2.43\text{mH}$, $R_G = 50\Omega$, $I_{AS} = 2.9\text{A}$.
- ③ Pulse width $\leq 400\mu\text{s}$; duty cycle $\leq 2\%$.
- ④ R_θ is measured at T_J of approximately 90°C .
- ⑤ When mounted on 1 inch square 2 oz copper pad on 1.5x1.5 in. board of FR-4 material.
- ⑥ Calculated continuous current based on maximum allowable junction temperature. Package is limited to 3.4A by wirebond capability.

Revision History

Date	Comments
12/16/2013	<ul style="list-style-type: none"> • Updated ordering information to reflect the End-Of-life (EOL) of the mini-reel option (EOL notice #259) • Updated data sheet with new IR corporate template