

# Clock Generator for Audio/Video Equipment

## BU2362FV

### General Description

BU2362FV is a clock generator IC capable of generating three types of clocks - VIDEO, AUDIO and SYSTEM clocks that are necessary for DVD player systems. It is a single chip solution that uses PLL technology. Particularly, the AUDIO clock is a DVD-Video reference and yet achieves high C/N characteristics that have low level of distortion factor.

### Features

- Connecting a crystal oscillator generates multiple clock signals from a built-in PLL circuit.
- AUDIO clock of high C/N characteristics providing a low level of distortion factor
- The AUDIO clock provides switching selection outputs.
- Single power supply of 3.3V

### Applications

DVD players

### Key Specifications

Part Name		BU2362FV	
Power Source Voltage [V]		2.7 to 3.6	
Reference Frequency [MHz]		27.0000	
Output Frequency [MHz]	DVD VIDEO	1	27.0000
	DVD AUDIO, CD (Switching outputs)	512fs	24.5760 22.5792
		other	36.8640 16.9344
	SYSTEM	768 (48k type)	36.8640
		768 (44.1k type)	33.8688
		384 (44.1k type)	16.9344
Jitter 1σ [psec]		70	
Long-term-Jitter p-p [nsec]		5.0	
Operating Temperature Range [°C]		-25 to +85	

### Package

W(Typ) x D(Typ) x H(Max)



### Typical Application Circuit

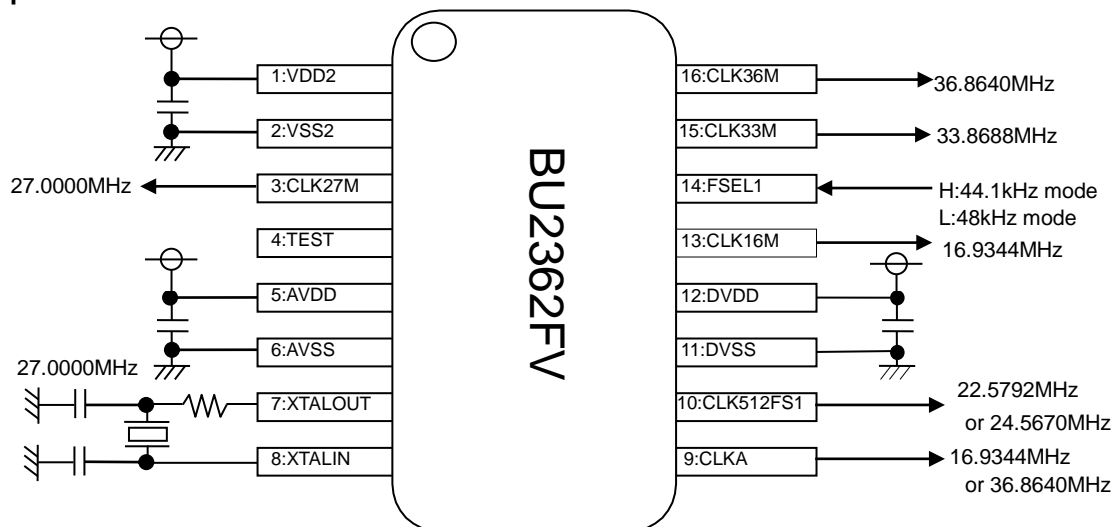

(Note) We believe that this circuit is to be recommended. However, to use it, make further thorough check for the characteristics.

○Product structure : Silicon monolithic integrated circuit ○This product has no designed protection against radioactive rays

www.rohm.com

© 2015 ROHM Co., Ltd. All rights reserved.  
TSZ22111 · 14 · 001

Pin Configuration

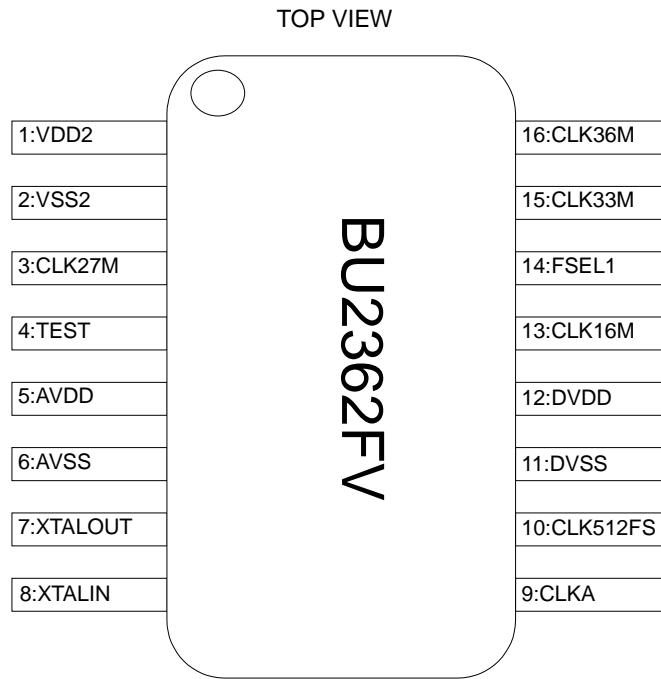

FSEL1	CLK512FS	CLKA
OPEN	22.5792MHz	16.9344MHz
L	24.5760MHz	36.8640MHz

Pin Descriptions

Pin No.	Pin Name	Function
1	VDD2	Power supply for CLK27M, CLK36M
2	VSS2	GND for CLK27M, CLK36M
3	CLK27M	27MHz Clock output terminal
4	TEST	Input pin for TEST : with pull-down (Please set "L" or OPEN, normally)
5	AVDD	Power supply for Analog block
6	AVSS	GND for Analog block
7	XTALOUT	Crystal output terminal
8	XTALIN	Crystal input terminal
9	CLKA	CLKA output terminal (16.9344MHz or 36.8640MHz)
10	CLK512FS	512fs Clock output terminal (22.5792MHz or 24.5760MHz)
11	DVSS	Power supply for Digital block
12	DVDD	GND for Digital block
13	CLK16M	16.9344MHz Clock output terminal
14	FSEL1	CLKA or CLK512FS pin output select : with pull-up
15	CLK33M	33.8688MHz Clock output terminal
16	CLK36M	36.8640MHz Clock output terminal

(Note) Basically, mount ICs to the printed circuit board for use. (If the ICs are not mounted to the printed circuit board, the characteristics of ICs may not be fully demonstrated.)  
 Mount 0.1μF capacitors in the vicinity of the IC PINs between PIN 1 (VDD2) and PIN 2 (VSS2), PIN 5 (AVDD) and PIN 6 (AVSS), PIN 11 (DVSS) and PIN 12 (DVDD), respectively.  
 For the fine-tuning of frequencies, insert several numbers of pF in the PIN 7 and PIN 8 to GND.  
 Depending on the conditions of the printed circuit board, mount an additional electrolytic capacitor between the power supply and GND terminal.  
 For EMI protection, it is effective to put ferrite beads in the origin of power to be supplied to the BU2362FV from the board or to insert a capacitor (of not more than 1Ω), which bypasses high frequency desired, between the power supply and the GND.

Block Diagram

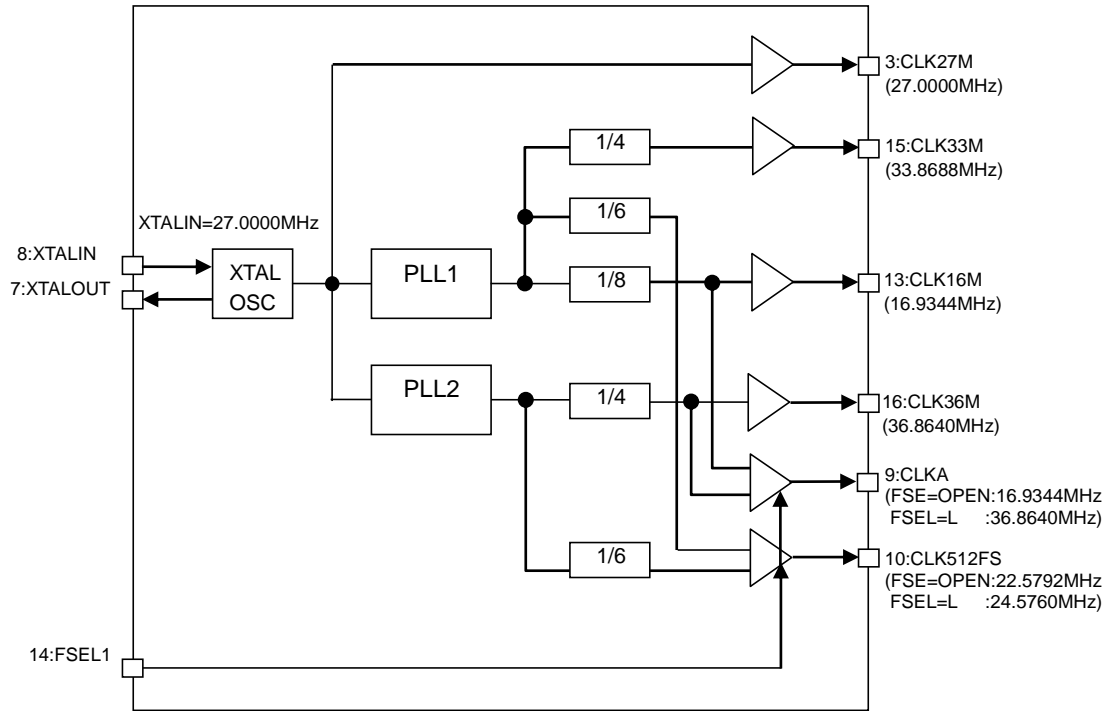

## Absolute Maximum Ratings (Ta=25°C)

Parameter	Symbol	Rating	Unit
Supply Voltage	V <sub>DD</sub>	-0.5 to +7.0	V
Input Voltage	V <sub>IN</sub>	-0.5 to V <sub>DD</sub> +0.5	V
Storage Temperature Range	T <sub>stg</sub>	-30 to +125	°C
Power Dissipation	P <sub>d</sub>	0.45 (Note 1)	W

(Note 1) In the case of exceeding Ta = 25°C, 4.5mW to be reduced per 1°C

(Note) Operating is not guaranteed.

(Note) Power dissipation is measured when the IC is mounted to the printed circuit board.

**Caution:** Operating the IC over the absolute maximum ratings may damage the IC. The damage can either be a short circuit between pins or an open circuit between pins and the internal circuitry. Therefore, it is important to consider circuit protection measures, such as adding a fuse, in case the IC is operated over the absolute maximum ratings.

## Recommended Operating Conditions

Parameter	Symbol	Limit	Unit
Supply Voltage	V <sub>DD</sub>	2.7 to 3.6	V
Input "H" Voltage	V <sub>IH</sub>	0.8V <sub>DD</sub> to V <sub>DD</sub>	V
Input "L" Voltage	V <sub>IL</sub>	0.0 to 0.2V <sub>DD</sub>	V
Operating Temperature	T <sub>opr</sub>	-25 to +85	°C
Output Load	C <sub>L</sub>	15	pF

Electrical Characteristics (V<sub>DD</sub>=3.3V, Ta=25°C, Crystal frequency 27.0000MHz, unless otherwise specified.)

Parameter	Symbol	Limit			Unit	Conditions
		Min	Typ	Max		
Output L Voltage	V <sub>OH</sub>	2.4	-	-	V	I <sub>OH</sub> =-4.0mA
Output H Voltage	V <sub>OL</sub>	-	-	0.4	V	I <sub>OL</sub> =4.0mA
Action Circuit Current	I <sub>DD</sub>	-	35	45	mA	At no load
CLK512FS	CLK512-44	-	22.5792	-	MHz	At FSEL1=OPEN XTAL x 3136/625/6
	CLK512-48	-	24.5760	-	MHz	At FSEL1=L XTAL x 2048/375/6
CLKA	CLKA-A	-	16.9344	-	MHz	At FSEL1=OPEN XTAL x 3136/625/8
	CLKA-B	-	36.8640	-	MHz	At FSEL1=L XTAL x 2048/375/8
CLK36M	CLK36M	-	36.8640	-	MHz	XTAL x 2048/375/4
CLK33M	CLK33M	-	33.8688	-	MHz	XTAL x 3136/625/4
CLK16M	CLK16M	-	16.9344	-	MHz	XTAL x 3136/625/8
CLK27M	CLK27M	-	27.0000	-	MHz	XTAL direct out
Duty	Duty	45	50	55	%	Measured at a voltage of 1/2 of VDD
Period-Jitter 1σ	P-J 1σ	-	70	-	psec	(Note 1)
Period-Jitter MIN-MAX	P-J MIN-MAX	-	420	-	psec	(Note 2)
Rise Time	t <sub>R</sub>	-	2.5	-	nsec	Period of transition time required for The output reach 80% from 20% of VDD.
Fall Time	t <sub>F</sub>	-	2.5	-	nsec	Period of transition time required for The output reach 20% from 80% of VDD.
Output Lock-Time	t <sub>LOCK</sub>	-	-	1	msec	(Note 3)

(Note) The output frequency is determined by the arithmetic (frequency division) expression of a frequency input to XTALIN.  
If the input frequency is set to 27.0000MHz, the output frequency will be as listed above.

(Note 1) Period-Jitter 1σ

This parameter represents standard deviation (=1 σ) on cycle distribution data at the time when the output clock cycles are sampled 1000 times consecutively with the TDS7104 Digital Phosphor Oscilloscope of Tektronix Japan, Ltd.

(Note 2) Period-Jitter MIN-MAX

This parameter represents a maximum distribution width on cycle distribution data at the time when the output clock cycles are sampled 1000 times consecutively with the TDS7104 Digital Phosphor Oscilloscope of Tektronix Japan, Ltd.

(Note 3) Output Lock-Time

The Lock-Time represents elapsed time after power supply turns ON to reach a 3.0V voltage, after the system is switched from Power-Down state to normal operation state, or after the output frequency is switched, until it is stabilized at a specified frequency, respectively.

Typical Performance Curves  
(Basic Data)

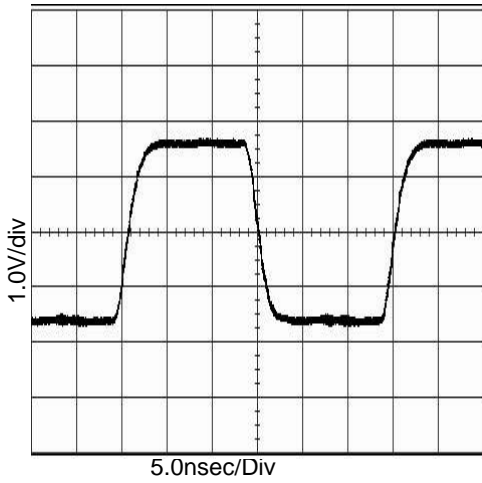

Figure 1. 33.9MHz Output Waveform  
(V<sub>DD</sub>=3.3V, at C<sub>L</sub>=15pF)

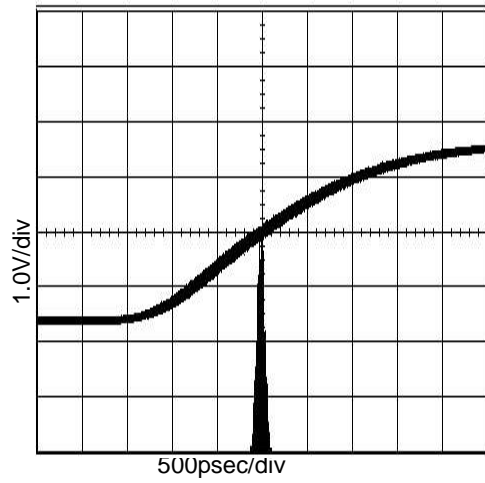

Figure 2. 33.9MHz Period-Jitter  
(V<sub>DD</sub>=3.3V, at C<sub>L</sub>=15pF)

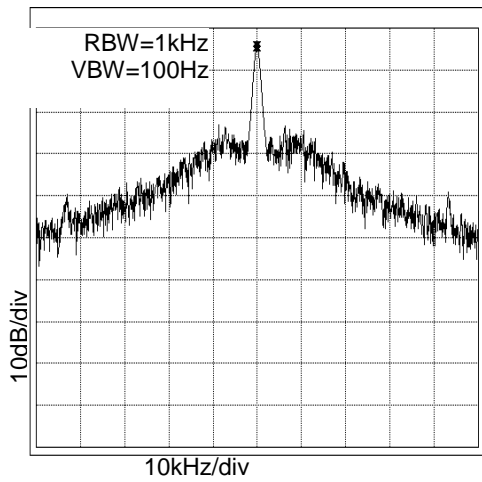

Figure 3. 33.9MHz Spectrum  
(V<sub>DD</sub>=3.3V, at C<sub>L</sub>=15pF)

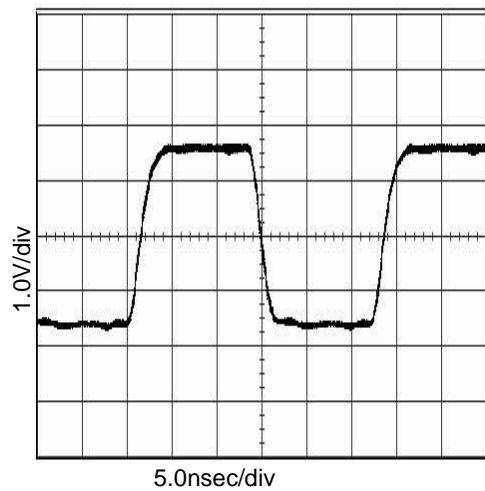

Figure 4. 36.9MHz Output Waveform  
(V<sub>DD</sub>=3.3V, at C<sub>L</sub>=15pF)

Typical Performance Curves – continued

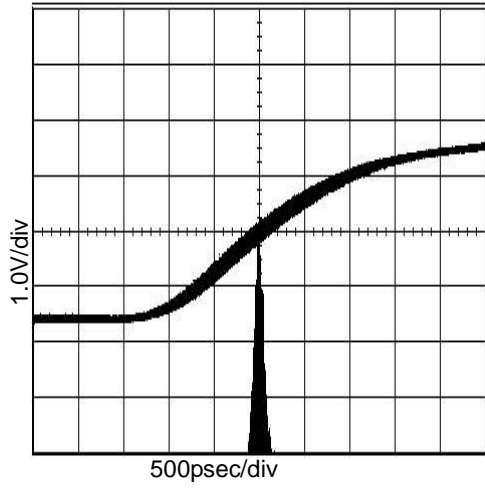

Figure 5. 36.9MHz Period-Jitter  
( $V_{DD}=3.3V$ , at  $C_L=15pF$ )

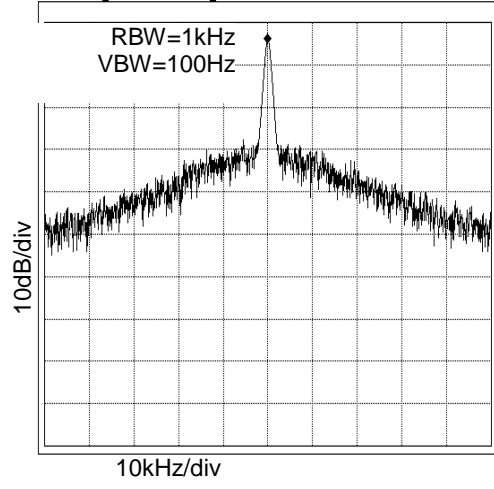

Figure 6. 36.9MHz Spectrum  
( $V_{DD}=3.3V$ , at  $C_L=15pF$ )

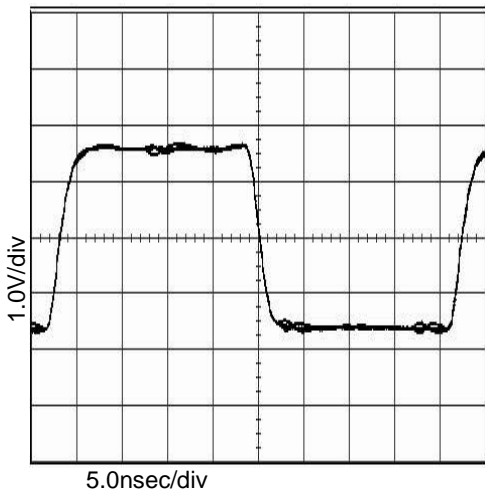

Figure 7. 22.6MHz Output Waveform  
( $V_{DD}=3.3V$ , at  $C_L=15pF$ )

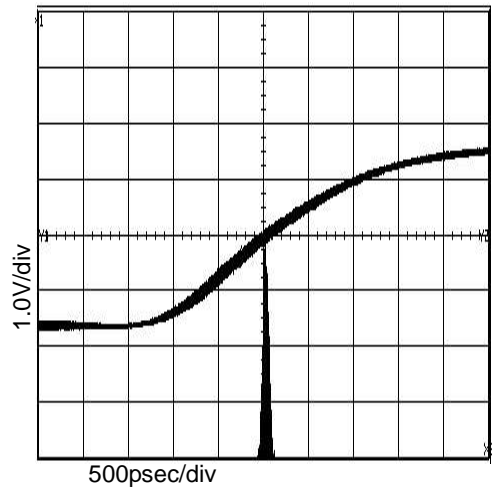

Figure 8. 22.6MHz Period-Jitter  
( $V_{DD}=3.3V$ , at  $C_L=15pF$ )

Typical Performance Curves – continued

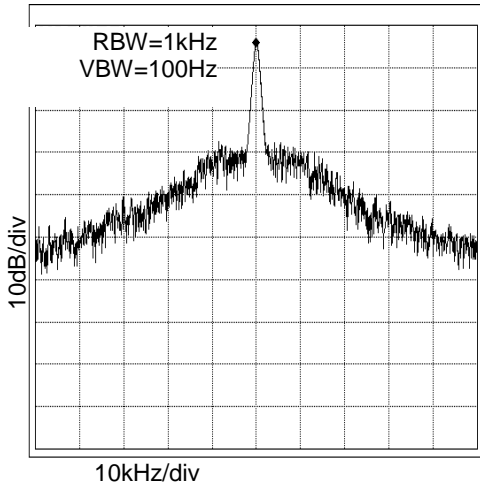

Figure 9. 22.6MHz Spectrum  
( $V_{DD}=3.3V$ , at  $C_L=15pF$ )

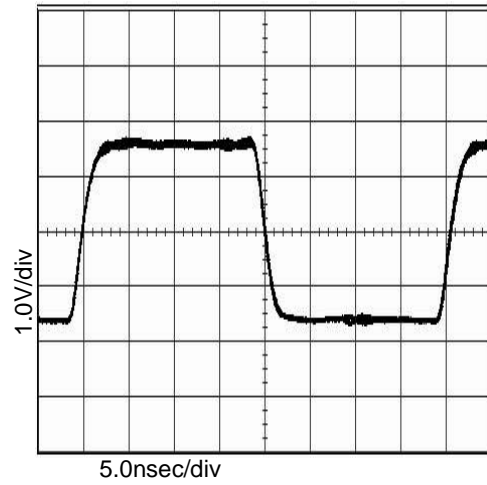

Figure 10. 24.6MHz Output Waveform  
( $V_{DD}=3.3V$ , at  $C_L=15pF$ )

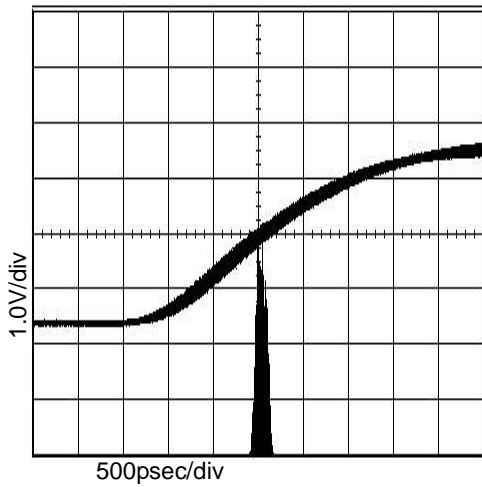

Figure 11. 24.6MHz Period-Jitter  
( $V_{DD}=3.3V$ , at  $C_L=15pF$ )

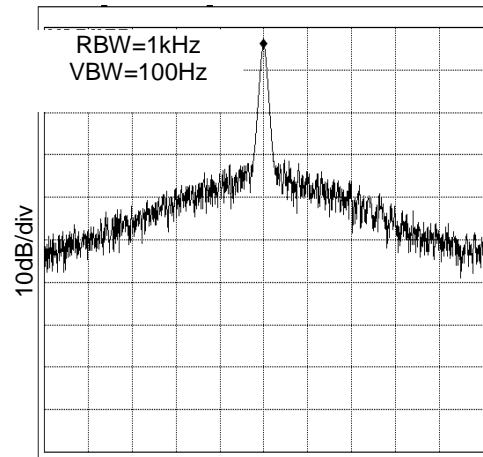

Figure 12. 24.6MHz Spectrum  
( $V_{DD}=3.3V$ , at  $C_L=15pF$ )

Typical Performance Curves – continued

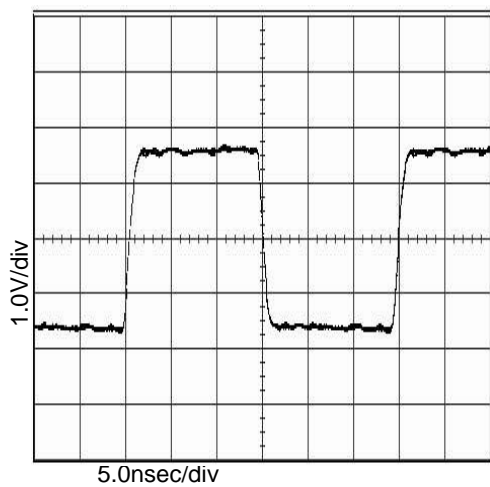

Figure 13. 16.9MHz Output Waveform  
( $V_{DD}=3.3V$ , at  $C_L=15pF$ )

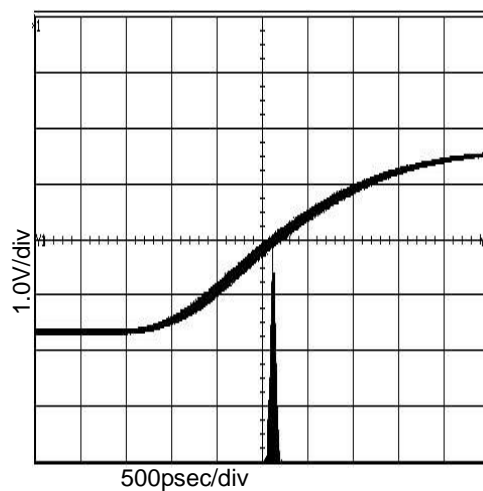

Figure 14. 16.9MHz Period-Jitter  
( $V_{DD}=3.3V$ , at  $C_L=15pF$ )

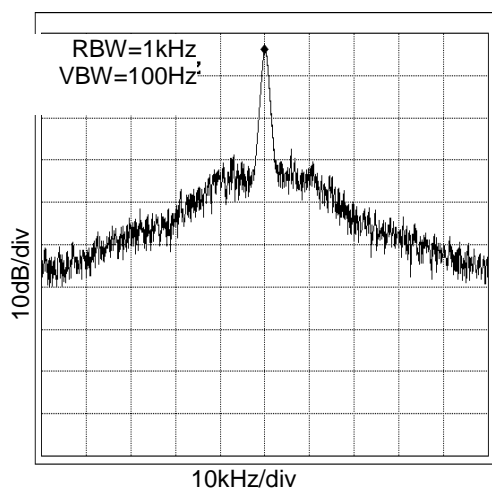

Figure 15. 16.9MHz Spectrum  
( $V_{DD}=3.3V$ , at  $C_L=15pF$ )

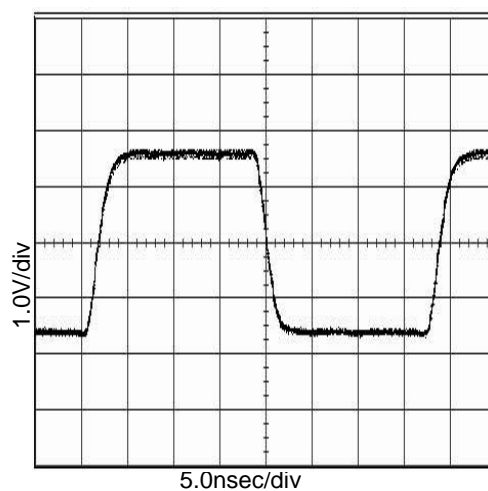

Figure 16. 27MHz Output Waveform  
( $V_{DD}=3.3V$ , at  $C_L=15pF$ )



Typical Performance Curves – continued

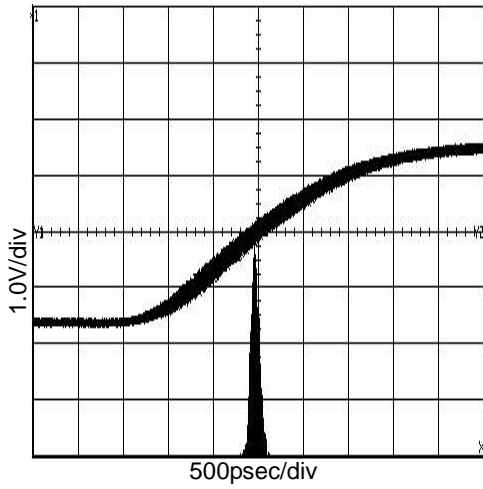

Figure 17. 27MHz Period-Jitter  
( $V_{DD}=3.3V$ , at  $C_L=15pF$ )

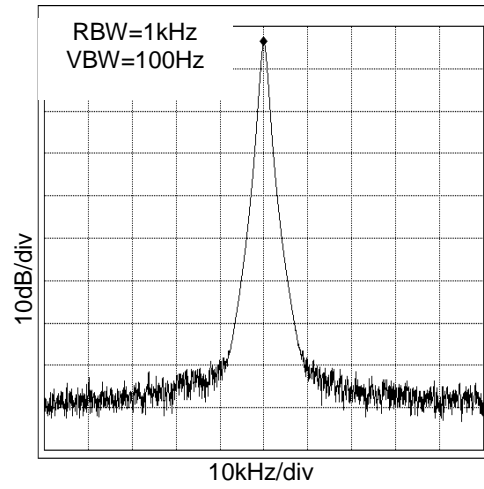

Figure 18. 27MHz Spectrum  
( $V_{DD}=3.3V$ , at  $C_L=15pF$ )

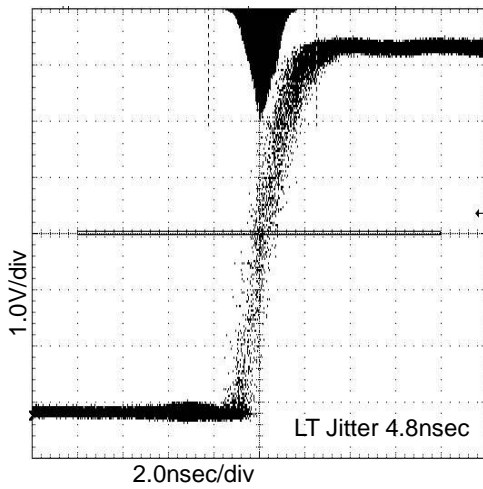

Figure 19 24.6MHz LT Jitter  
( $V_{DD}=3.3V$ , at  $C_L=15pF$ )

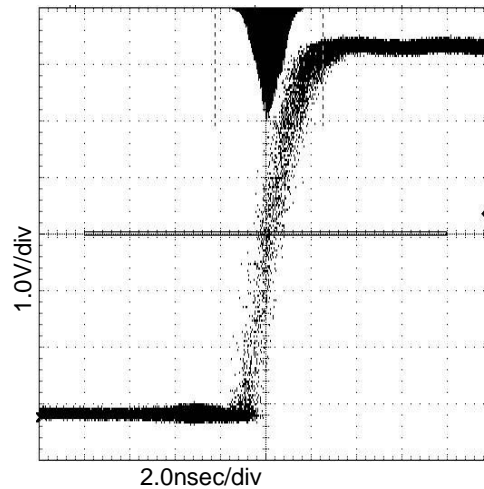

Figure 20. 22.6MHz LT Jitter  
( $V_{DD}=3.3V$ , at  $C_L=15pF$ )

**Typical Performance Curves – continued**  
 (Temperature and Supply voltage variations data)

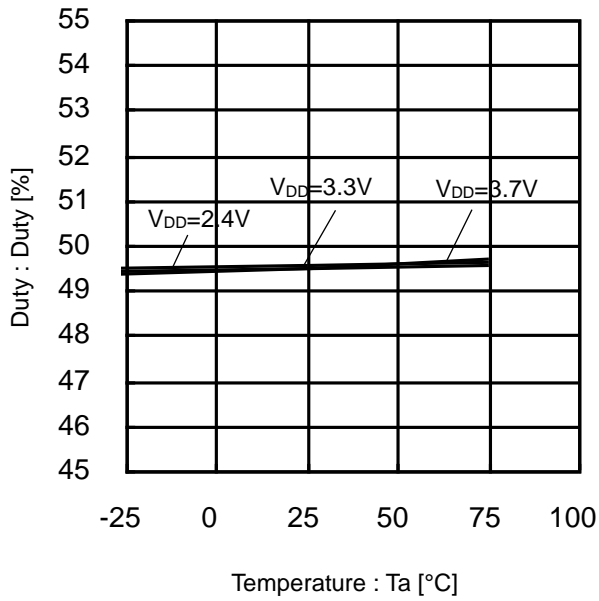

Figure 21. Duty vs Temperature (33.9MHz)

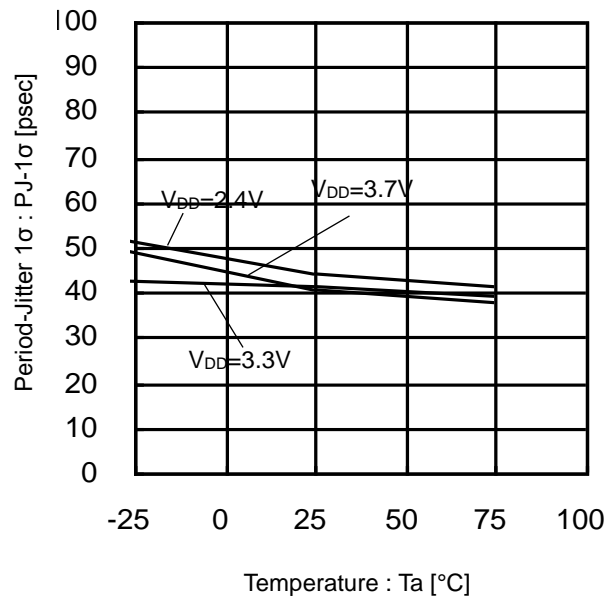

Figure 22. Period-Jitter 1σ vs Temperature (33.9MHz)

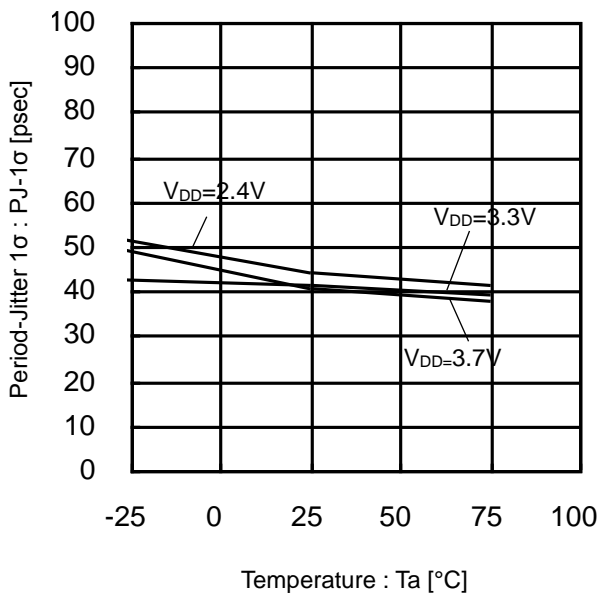

Figure 23. Period-Jitter MIN-MAX vs Temperature (33.9MHz)

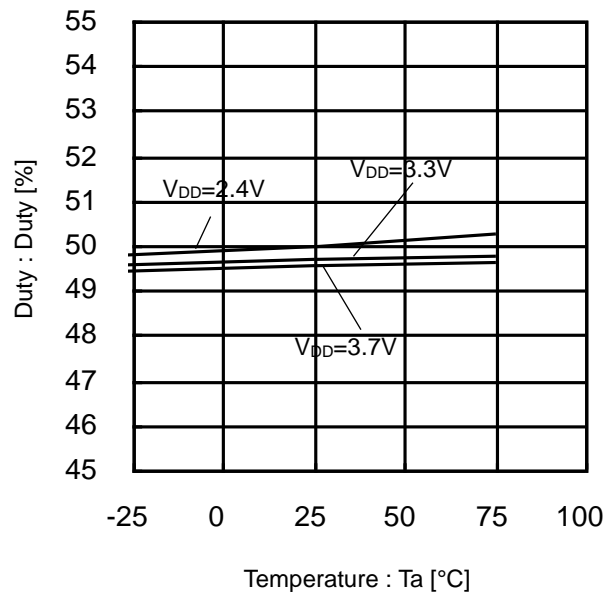

Figure 24. Duty vs Temperature (36.9MHz)

Typical Performance Curves – continued

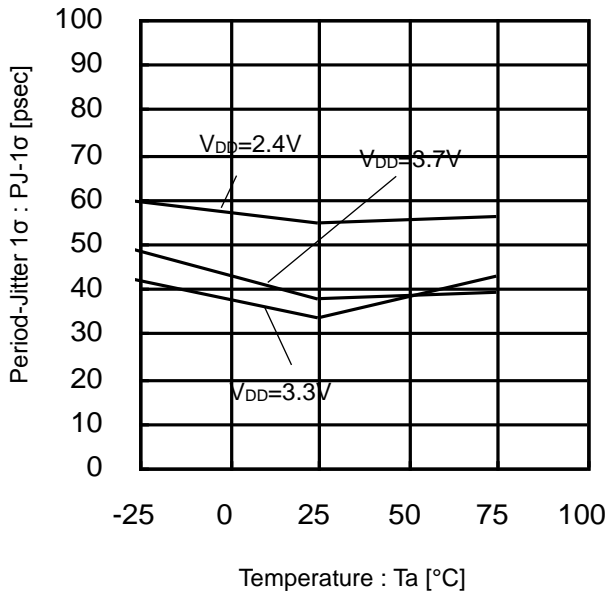

Figure 25. Period-Jitter 1σ vs Temperature (36.9MHz)

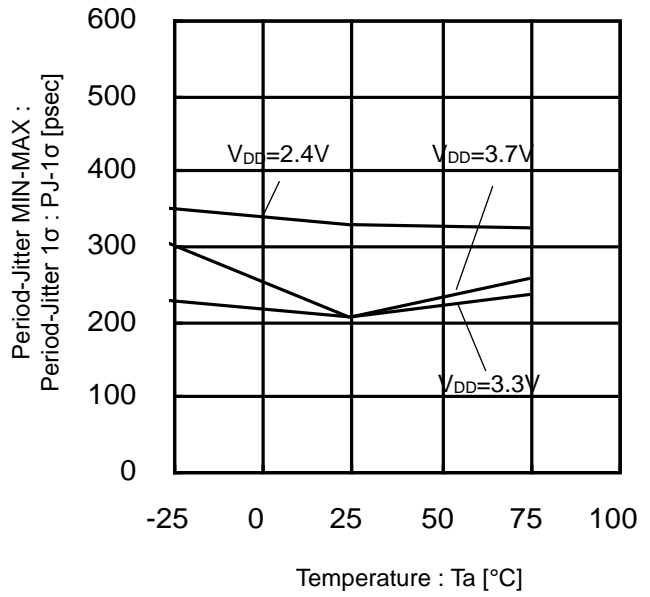

Figure 26. Period-Jitter MIN-MAX vs Temperature (36.9MHz)

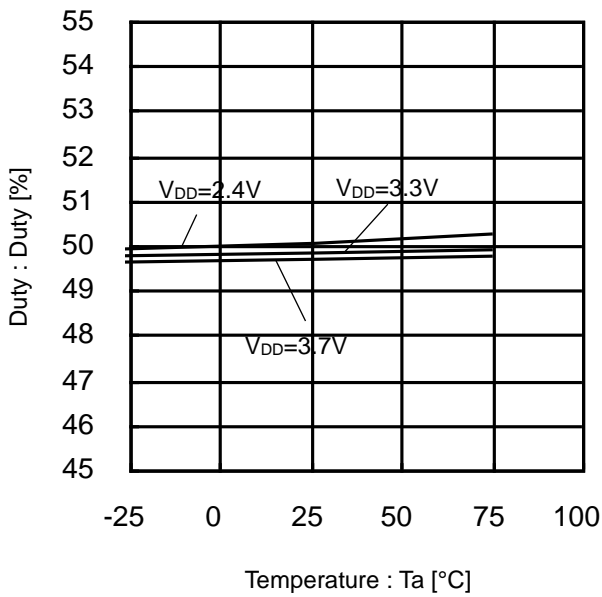

Figure 27. Duty vs Temperature (22.6MHz)

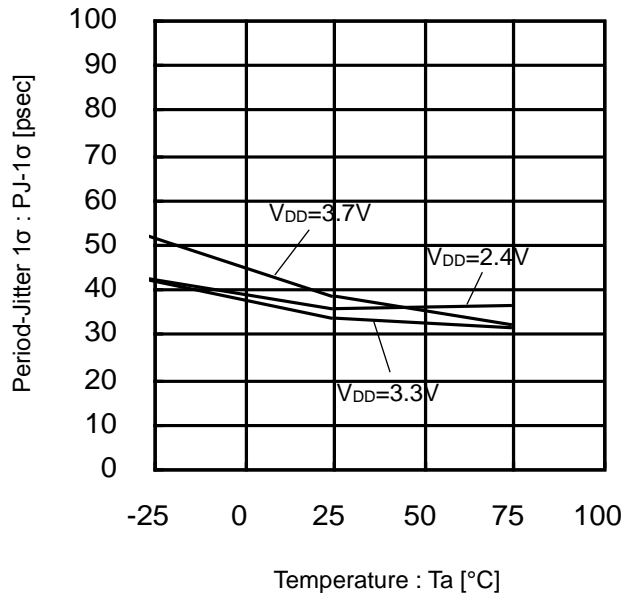

Figure 28. Period-Jitter 1σ vs Temperature (22.6MHz)

Typical Performance Curves – continued

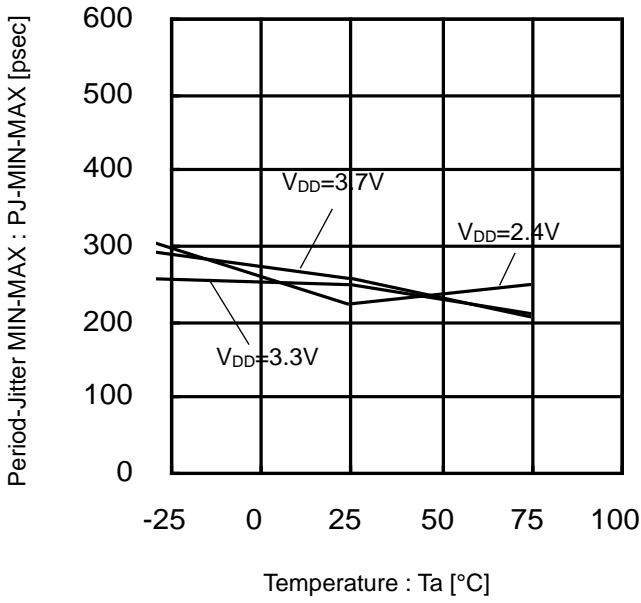

Figure 29. Period-Jitter MIN-MAX vs Temperature (22.6MHz)

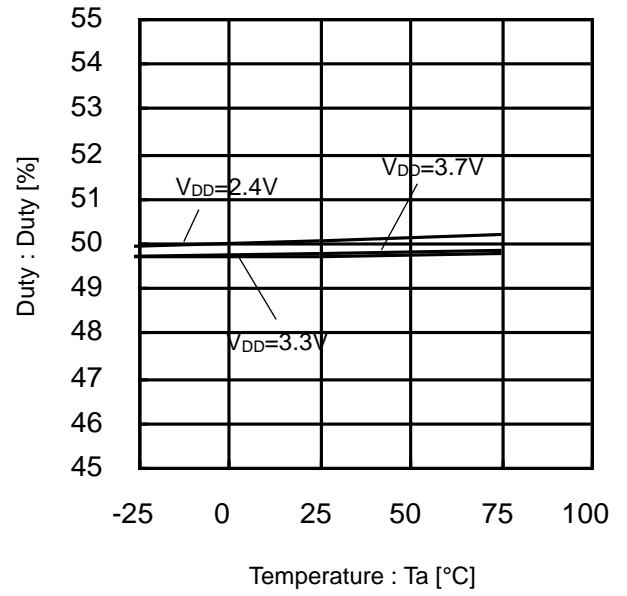

Figure 30. Duty vs Temperature (24.6MHz)

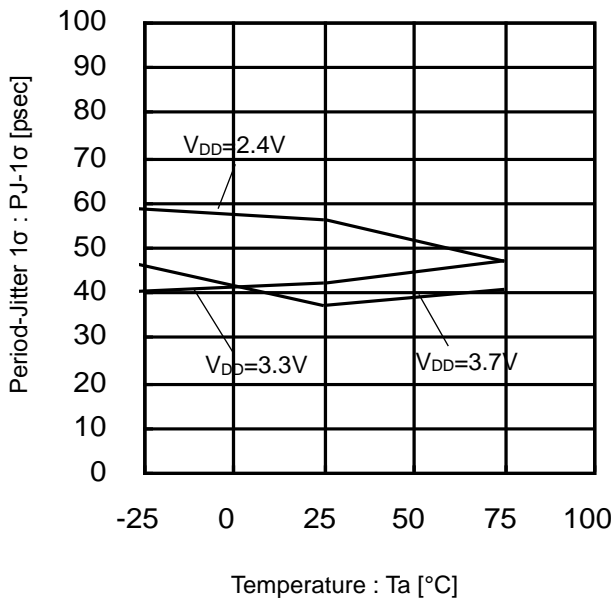

Figure 31. Period-Jitter 1σ vs Temperature (24.6MHz)

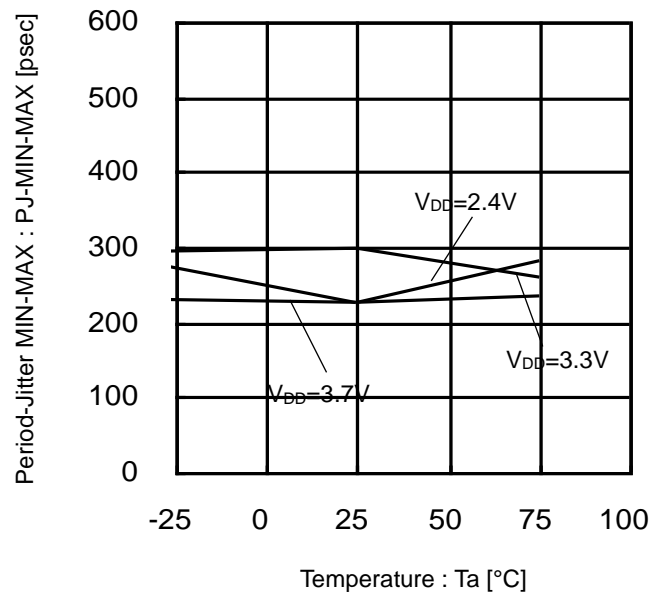

Figure 32. Period-Jitter MIN-MAX vs Temperature (24.6MHz)

Typical Performance Curves – continued

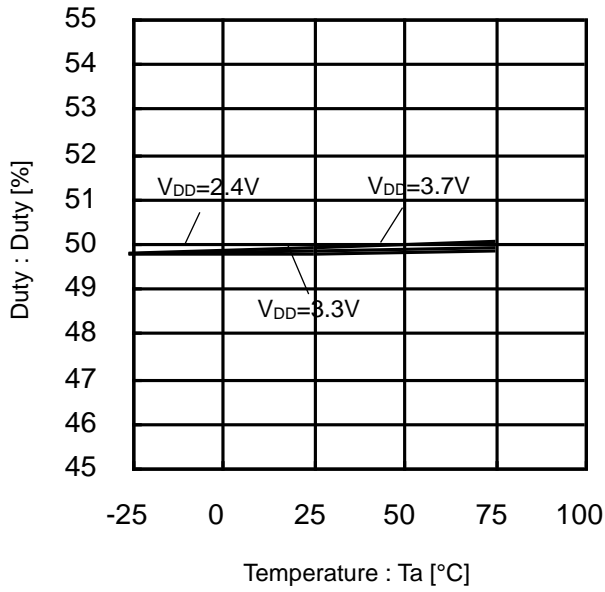

Figure 33. Duty vs Temperature (16.9MHz)

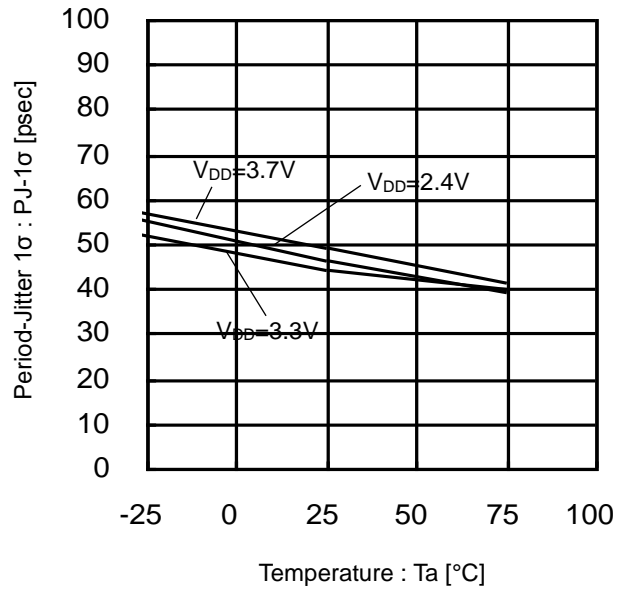

Figure 34. Period-Jitter 1σ vs Temperature (16.9MHz)

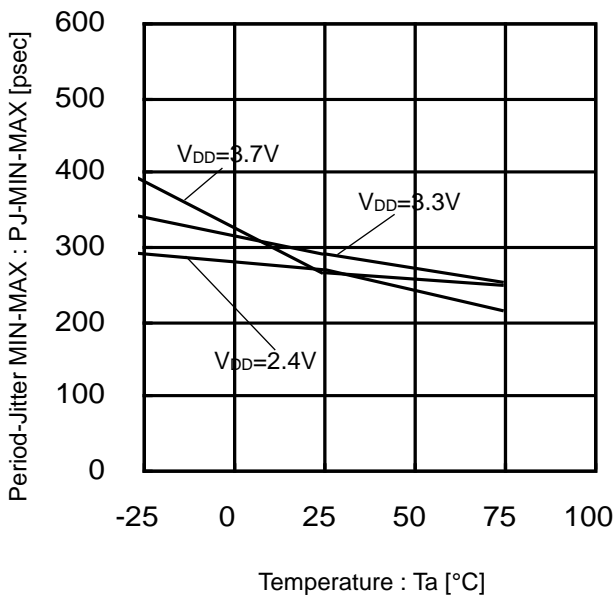

Figure 35. Period-Jitter MIN-MAX vs Temperature (16.9MHz)

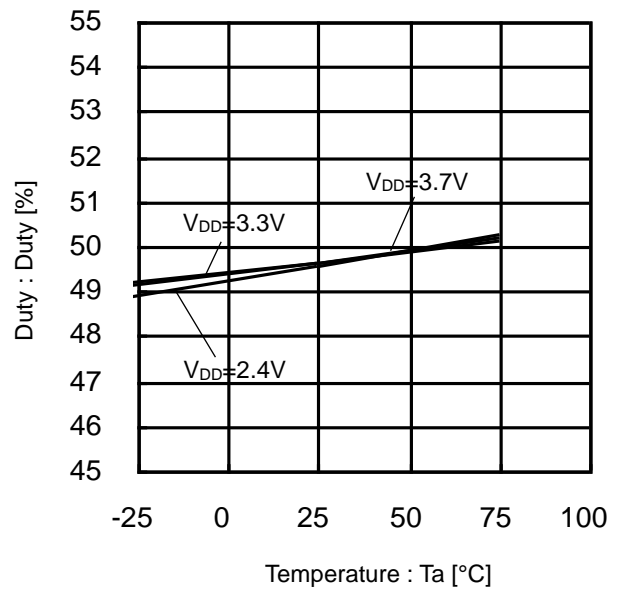

Figure 36. Duty vs Temperature (27MHz)

Typical Performance Curves – continued

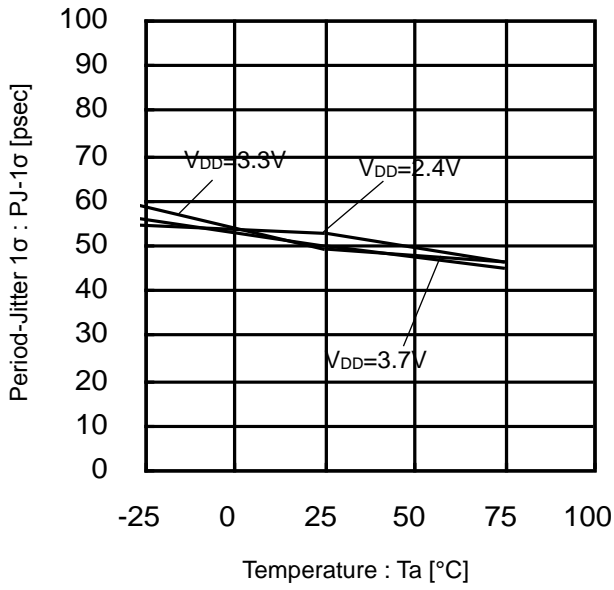

Figure 37. Period-Jitter 1σ vs Temperature (27MHz)

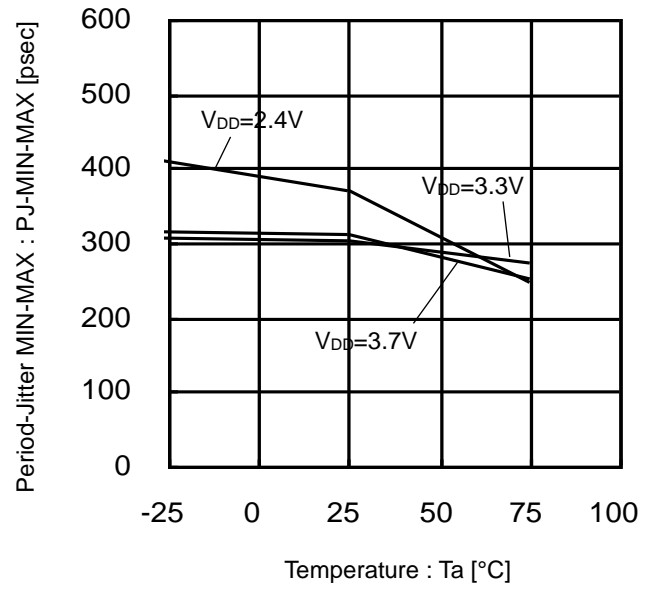

Figure 38. Period-Jitter MIN-MAX vs Temperature (27MHz)

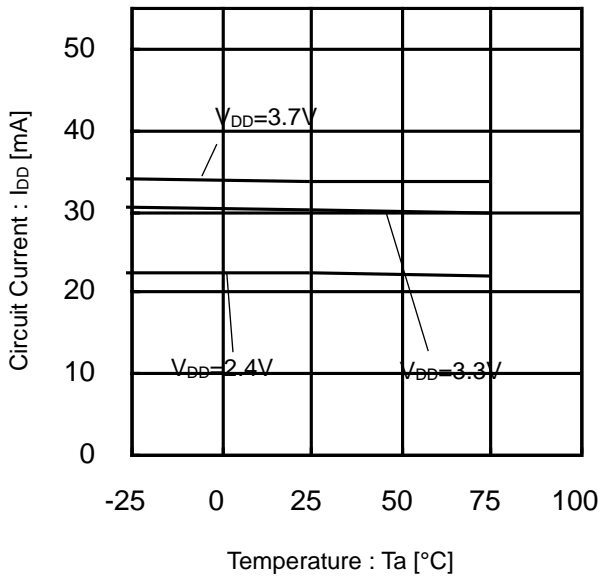

Figure 39. Consumption Current vs Temperature  
Action Circuit Current  
(With Maximum Output Load)

## Operational Notes

### 1. Reverse Connection of Power Supply

Connecting the power supply in reverse polarity can damage the IC. Take precautions against reverse polarity when connecting the power supply, such as mounting an external diode between the power supply and the IC's power supply pins.

### 2. Power Supply Lines

Design the PCB layout pattern to provide low impedance supply lines. Separate the ground and supply lines of the digital and analog blocks to prevent noise in the ground and supply lines of the digital block from affecting the analog block. Furthermore, connect a capacitor to ground at all power supply pins. Consider the effect of temperature and aging on the capacitance value when using electrolytic capacitors.

### 3. Ground Voltage

Ensure that no pins are at a voltage below that of the ground pin at any time, even during transient condition.

### 4. Ground Wiring Pattern

When using both small-signal and large-current ground traces, the two ground traces should be routed separately but connected to a single ground at the reference point of the application board to avoid fluctuations in the small-signal ground caused by large currents. Also ensure that the ground traces of external components do not cause variations on the ground voltage. The ground lines must be as short and thick as possible to reduce line impedance.

### 5. Thermal Consideration

Should by any chance the power dissipation rating be exceeded the rise in temperature of the chip may result in deterioration of the properties of the chip. In case of exceeding this absolute maximum rating, increase the board size and copper area to prevent exceeding the Pd rating.

### 6. Recommended Operating Conditions

These conditions represent a range within which the expected characteristics of the IC can be approximately obtained. The electrical characteristics are guaranteed under the conditions of each parameter.

### 7. Inrush Current

When power is first supplied to the IC, it is possible that the internal logic may be unstable and inrush current may flow instantaneously due to the internal powering sequence and delays, especially if the IC has more than one power supply. Therefore, give special consideration to power coupling capacitance, power wiring, width of ground wiring, and routing of connections.

### 8. Operation Under Strong Electromagnetic Field

Operating the IC in the presence of a strong electromagnetic field may cause the IC to malfunction.

### 9. Testing on Application Boards

When testing the IC on an application board, connecting a capacitor directly to a low-impedance output pin may subject the IC to stress. Always discharge capacitors completely after each process or step. The IC's power supply should always be turned off completely before connecting or removing it from the test setup during the inspection process. To prevent damage from static discharge, ground the IC during assembly and use similar precautions during transport and storage.

### 10. Inter-pin Short and Mounting Errors

Ensure that the direction and position are correct when mounting the IC on the PCB. Incorrect mounting may result in damaging the IC. Avoid nearby pins being shorted to each other especially to ground, power supply and output pin. Inter-pin shorts could be due to many reasons such as metal particles, water droplets (in very humid environment) and unintentional solder bridge deposited in between pins during assembly to name a few.

### 11. Unused Input Pins

Input pins of an IC are often connected to the gate of a MOS transistor. The gate has extremely high impedance and extremely low capacitance. If left unconnected, the electric field from the outside can easily charge it. The small charge acquired in this way is enough to produce a significant effect on the conduction through the transistor and cause unexpected operation of the IC. So unless otherwise specified, unused input pins should be connected to the power supply or ground line.

**Operational Notes – continued****12. Regarding the Input Pin of the IC**

In the construction of this IC, P-N junctions are inevitably formed creating parasitic diodes or transistors. The operation of these parasitic elements can result in mutual interference among circuits, operational faults, or physical damage. Therefore, conditions which cause these parasitic elements to operate, such as applying a voltage to an input pin lower than the ground voltage should be avoided. Furthermore, do not apply a voltage to the input pins when no power supply voltage is applied to the IC. Even if the power supply voltage is applied, make sure that the input pins have voltages within the values specified in the electrical characteristics of this IC.

**13. Ceramic Capacitor**

When using a ceramic capacitor, determine the dielectric constant considering the change of capacitance with temperature and the decrease in nominal capacitance due to DC bias and others.



Ordering Information

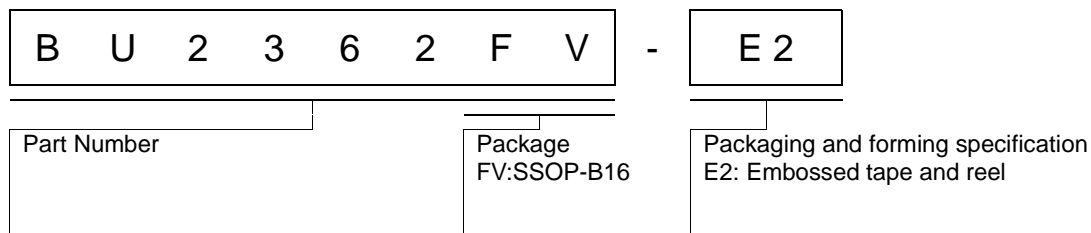

Marking Diagram

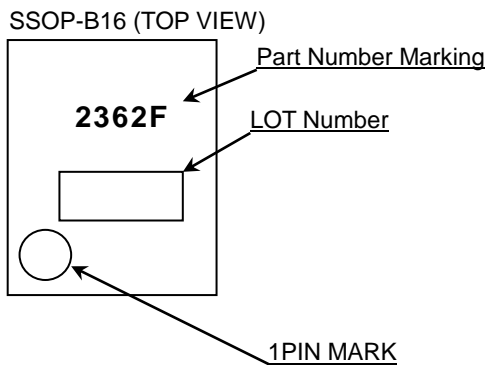

Physical Dimension, Tape and Reel Information

Package Name	SSOP-B16
--------------	----------

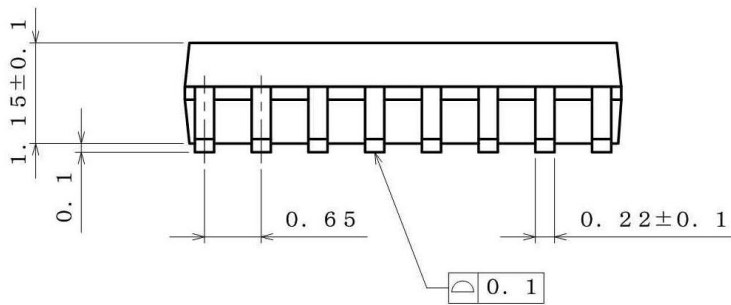
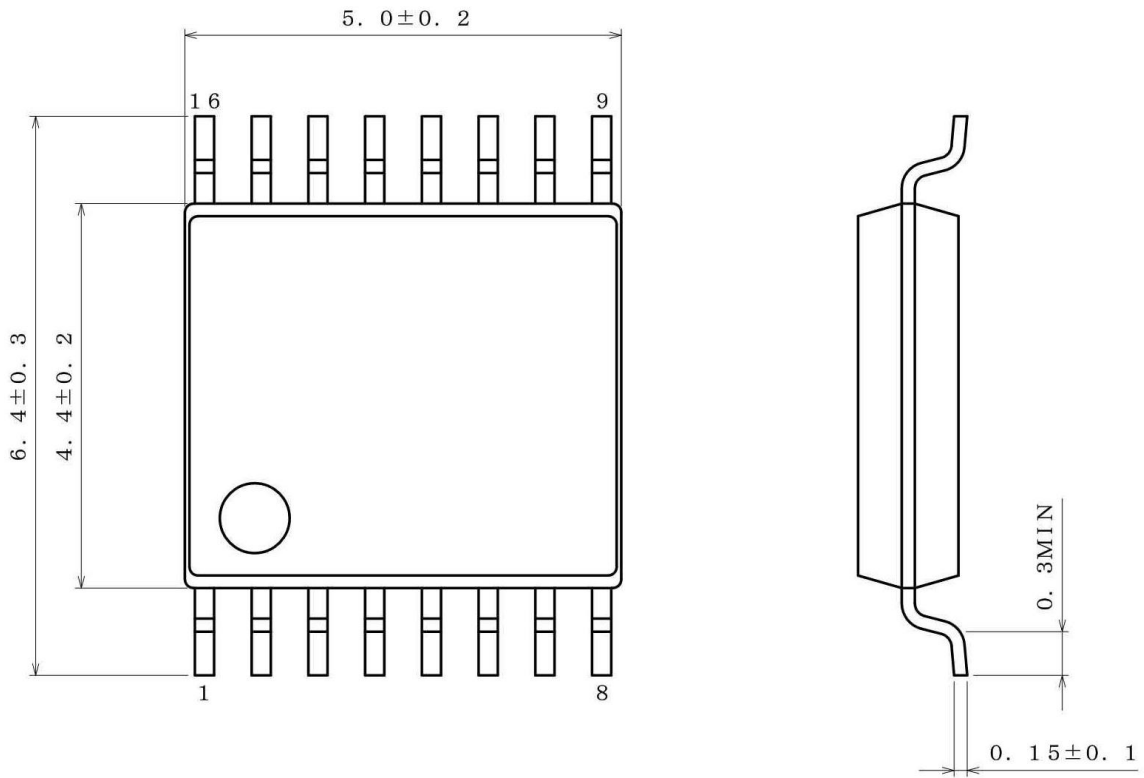

(UNIT : mm)  
 PKG : SSOP-B16  
 Drawing No. B0771

**<Tape and Reel information>**

Tape	Embossed carrier tape
Quantity	2500pcs
Direction of feed	E2 ( The direction is the 1pin of product is at the upper left when you hold reel on the left hand and you pull out the tape on the right hand )

Reel

1pin

Direction of feed

\*Order quantity needs to be multiple of the minimum quantity.

## Revision History

Date	Revision	Changes
04.Nov.2015	001	New Release

# Notice

## Precaution on using ROHM Products

- Our Products are designed and manufactured for application in ordinary electronic equipments (such as AV equipment, OA equipment, telecommunication equipment, home electronic appliances, amusement equipment, etc.). If you intend to use our Products in devices requiring extremely high reliability (such as medical equipment <sup>(Note 1)</sup>, transport equipment, traffic equipment, aircraft/spacecraft, nuclear power controllers, fuel controllers, car equipment including car accessories, safety devices, etc.) and whose malfunction or failure may cause loss of human life, bodily injury or serious damage to property ("Specific Applications"), please consult with the ROHM sales representative in advance. Unless otherwise agreed in writing by ROHM in advance, ROHM shall not be in any way responsible or liable for any damages, expenses or losses incurred by you or third parties arising from the use of any ROHM's Products for Specific Applications.

(Note1) Medical Equipment Classification of the Specific Applications

JAPAN	USA	EU	CHINA
CLASS III	CLASS III	CLASS II b	CLASS III
CLASS IV		CLASS III	

- ROHM designs and manufactures its Products subject to strict quality control system. However, semiconductor products can fail or malfunction at a certain rate. Please be sure to implement, at your own responsibilities, adequate safety measures including but not limited to fail-safe design against the physical injury, damage to any property, which a failure or malfunction of our Products may cause. The following are examples of safety measures:
  - Installation of protection circuits or other protective devices to improve system safety
  - Installation of redundant circuits to reduce the impact of single or multiple circuit failure
- Our Products are designed and manufactured for use under standard conditions and not under any special or extraordinary environments or conditions, as exemplified below. Accordingly, ROHM shall not be in any way responsible or liable for any damages, expenses or losses arising from the use of any ROHM's Products under any special or extraordinary environments or conditions. If you intend to use our Products under any special or extraordinary environments or conditions (as exemplified below), your independent verification and confirmation of product performance, reliability, etc. prior to use, must be necessary:
  - Use of our Products in any types of liquid, including water, oils, chemicals, and organic solvents
  - Use of our Products outdoors or in places where the Products are exposed to direct sunlight or dust
  - Use of our Products in places where the Products are exposed to sea wind or corrosive gases, including Cl<sub>2</sub>, H<sub>2</sub>S, NH<sub>3</sub>, SO<sub>2</sub>, and NO<sub>2</sub>
  - Use of our Products in places where the Products are exposed to static electricity or electromagnetic waves
  - Use of our Products in proximity to heat-producing components, plastic cords, or other flammable items
  - Sealing or coating our Products with resin or other coating materials
  - Use of our Products without cleaning residue of flux (even if you use no-clean type fluxes, cleaning residue of flux is recommended); or Washing our Products by using water or water-soluble cleaning agents for cleaning residue after soldering
  - Use of the Products in places subject to dew condensation
- The Products are not subject to radiation-proof design.
- Please verify and confirm characteristics of the final or mounted products in using the Products.
- In particular, if a transient load (a large amount of load applied in a short period of time, such as pulse. is applied, confirmation of performance characteristics after on-board mounting is strongly recommended. Avoid applying power exceeding normal rated power; exceeding the power rating under steady-state loading condition may negatively affect product performance and reliability.
- De-rate Power Dissipation depending on ambient temperature. When used in sealed area, confirm that it is the use in the range that does not exceed the maximum junction temperature.
- Confirm that operation temperature is within the specified range described in the product specification.
- ROHM shall not be in any way responsible or liable for failure induced under deviant condition from what is defined in this document.

## Precaution for Mounting / Circuit board design

- When a highly active halogenous (chlorine, bromine, etc.) flux is used, the residue of flux may negatively affect product performance and reliability.
- In principle, the reflow soldering method must be used on a surface-mount products, the flow soldering method must be used on a through hole mount products. If the flow soldering method is preferred on a surface-mount products, please consult with the ROHM representative in advance.

For details, please refer to ROHM Mounting specification

**Precautions Regarding Application Examples and External Circuits**

1. If change is made to the constant of an external circuit, please allow a sufficient margin considering variations of the characteristics of the Products and external components, including transient characteristics, as well as static characteristics.
2. You agree that application notes, reference designs, and associated data and information contained in this document are presented only as guidance for Products use. Therefore, in case you use such information, you are solely responsible for it and you must exercise your own independent verification and judgment in the use of such information contained in this document. ROHM shall not be in any way responsible or liable for any damages, expenses or losses incurred by you or third parties arising from the use of such information.

**Precaution for Electrostatic**

This Product is electrostatic sensitive product, which may be damaged due to electrostatic discharge. Please take proper caution in your manufacturing process and storage so that voltage exceeding the Products maximum rating will not be applied to Products. Please take special care under dry condition (e.g. Grounding of human body / equipment / solder iron, isolation from charged objects, setting of Ionizer, friction prevention and temperature / humidity control).

**Precaution for Storage / Transportation**

1. Product performance and soldered connections may deteriorate if the Products are stored in the places where:
  - [a] the Products are exposed to sea winds or corrosive gases, including Cl<sub>2</sub>, H<sub>2</sub>S, NH<sub>3</sub>, SO<sub>2</sub>, and NO<sub>2</sub>
  - [b] the temperature or humidity exceeds those recommended by ROHM
  - [c] the Products are exposed to direct sunshine or condensation
  - [d] the Products are exposed to high Electrostatic
2. Even under ROHM recommended storage condition, solderability of products out of recommended storage time period may be degraded. It is strongly recommended to confirm solderability before using Products of which storage time is exceeding the recommended storage time period.
3. Store / transport cartons in the correct direction, which is indicated on a carton with a symbol. Otherwise bent leads may occur due to excessive stress applied when dropping of a carton.
4. Use Products within the specified time after opening a humidity barrier bag. Baking is required before using Products of which storage time is exceeding the recommended storage time period.

**Precaution for Product Label**

QR code printed on ROHM Products label is for ROHM's internal use only.

**Precaution for Disposition**

When disposing Products please dispose them properly using an authorized industry waste company.

**Precaution for Foreign Exchange and Foreign Trade act**

Since concerned goods might be fallen under listed items of export control prescribed by Foreign exchange and Foreign trade act, please consult with ROHM in case of export.

**Precaution Regarding Intellectual Property Rights**

1. All information and data including but not limited to application example contained in this document is for reference only. ROHM does not warrant that foregoing information or data will not infringe any intellectual property rights or any other rights of any third party regarding such information or data.
2. ROHM shall not have any obligations where the claims, actions or demands arising from the combination of the Products with other articles such as components, circuits, systems or external equipment (including software).
3. No license, expressly or implied, is granted hereby under any intellectual property rights or other rights of ROHM or any third parties with respect to the Products or the information contained in this document. Provided, however, that ROHM will not assert its intellectual property rights or other rights against you or your customers to the extent necessary to manufacture or sell products containing the Products, subject to the terms and conditions herein.

**Other Precaution**

1. This document may not be reprinted or reproduced, in whole or in part, without prior written consent of ROHM.
2. The Products may not be disassembled, converted, modified, reproduced or otherwise changed without prior written consent of ROHM.
3. In no event shall you use in any way whatsoever the Products and the related technical information contained in the Products or this document for any military purposes, including but not limited to, the development of mass-destruction weapons.
4. The proper names of companies or products described in this document are trademarks or registered trademarks of ROHM, its affiliated companies or third parties.

**General Precaution**

1. Before you use our Products, you are requested to carefully read this document and fully understand its contents. ROHM shall not be in any way responsible or liable for failure, malfunction or accident arising from the use of any ROHM's Products against warning, caution or note contained in this document.
2. All information contained in this document is current as of the issuing date and subject to change without any prior notice. Before purchasing or using ROHM's Products, please confirm the latest information with a ROHM sales representative.
3. The information contained in this document is provided on an "as is" basis and ROHM does not warrant that all information contained in this document is accurate and/or error-free. ROHM shall not be in any way responsible or liable for any damages, expenses or losses incurred by you or third parties resulting from inaccuracy or errors of or concerning such information.



## BU2362FV - Web Page

[Distribution Inventory](#)

Part Number	BU2362FV
Package	SSOP-B16
Unit Quantity	2500
Minimum Package Quantity	2500
Packing Type	Taping
Constitution Materials List	inquiry
RoHS	Yes