

TO-92 Plastic-Encapsulate Transistors

2SC1815 TRANSISTOR (NPN)

FEATURES

- Power dissipation

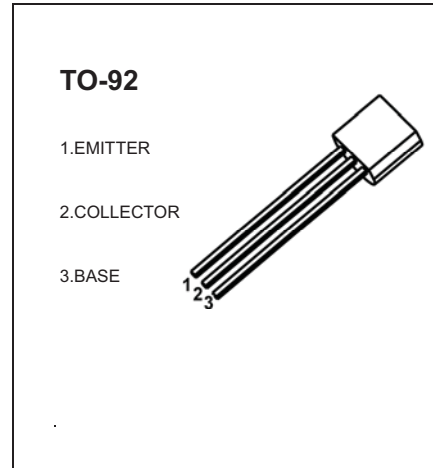

MARKING

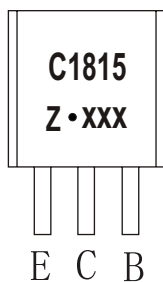

C1815=Device code
 Solid dot=Green molding compound device,
 if none,the normal device
 Z=Rank of h_{FE} ,
 XXX=Code

Equivalent Circuit

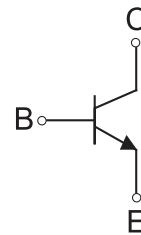

ORDERING INFORMATION

| Part Number | Package | Packing Method | Pack Quantity |
|-------------|---------|----------------|---------------|
| 2SC1815 | TO-92 | Bulk | 1000pcs/Bag |
| 2SC1815-TA | TO-92 | Tape | 2000pcs/Box |

MAXIMUM RATINGS ($T_a=25^{\circ}\text{C}$ unless otherwise noted)

| Symbol | Parameter | Value | Unit |
|-----------------|---|----------|-------------------------------|
| V_{CBO} | Collector-Base Voltage | 60 | V |
| V_{CEO} | Collector-Emitter Voltage | 50 | V |
| V_{EBO} | Emitter-Base Voltage | 5 | V |
| I_c | Collector Current -Continuous | 0.15 | A |
| P_D | Collector Power Dissipation | 400 | mW |
| $R_{\theta JA}$ | Thermal Resistance from Junction to Ambient | 312.5 | $^{\circ}\text{C} / \text{W}$ |
| T_j | Junction Temperature | 150 | $^{\circ}\text{C}$ |
| T_{stg} | Storage Temperature | -55~+150 | $^{\circ}\text{C}$ |

ELECTRICAL CHARACTERISTICS

$T_a=25^\circ\text{C}$ unless otherwise specified

| Parameter | Symbol | Test conditions | Min | Typ | Max | Unit |
|--------------------------------------|---------------|---|-----|-----|------|---------------|
| Collector-base breakdown voltage | $V_{(BR)CBO}$ | $I_C=100\mu\text{A}, I_E=0$ | 60 | | | V |
| Collector-emitter breakdown voltage | $V_{(BR)CEO}$ | $I_C=0.1\text{mA}, I_B=0$ | 50 | | | V |
| Emitter-base breakdown voltage | $V_{(BR)EBO}$ | $I_E=100\mu\text{A}, I_C=0$ | 5 | | | V |
| Collector cut-off current | I_{CBO} | $V_{CB}=60\text{V}, I_E=0$ | | | 0.1 | μA |
| Collector cut-off current | I_{CEO} | $V_{CE}=50\text{V}, I_B=0$ | | | 0.1 | μA |
| Emitter cut-off current | I_{EBO} | $V_{EB}=5\text{V}, I_C=0$ | | | 0.1 | μA |
| DC current gain | h_{FE} | $V_{CE}=6\text{V}, I_C=2\text{mA}$ | 70 | | 700 | |
| Collector-emitter saturation voltage | $V_{CE(sat)}$ | $I_C=100\text{mA}, I_B=10\text{mA}$ | | | 0.25 | V |
| Base-emitter saturation voltage | $V_{BE(sat)}$ | $I_C=100\text{mA}, I_B=10\text{mA}$ | | | 1 | V |
| Transition frequency | f_T | $V_{CE}=10\text{V}, I_C=1\text{mA}$ $f=30\text{MHz}$ | 80 | | | MHz |
| Collector Output Capacitance | C_{ob} | $V_{CB}=10\text{V}, I_E=0$ $f=1\text{MHz}$ | | | 3.5 | pF |
| Noise Figure | NF | $V_{CE}=6\text{V}, I_C=0.1\text{mA}$ $f=1\text{KHz}, R_G=10\text{K}$ | | | 10 | dB |

CLASSIFICATION OF h_{FE}

| Rank | O | Y | GR | BL |
|-------|--------|---------|---------|---------|
| Range | 70-140 | 120-240 | 200-400 | 350-700 |

Typical Characteristics

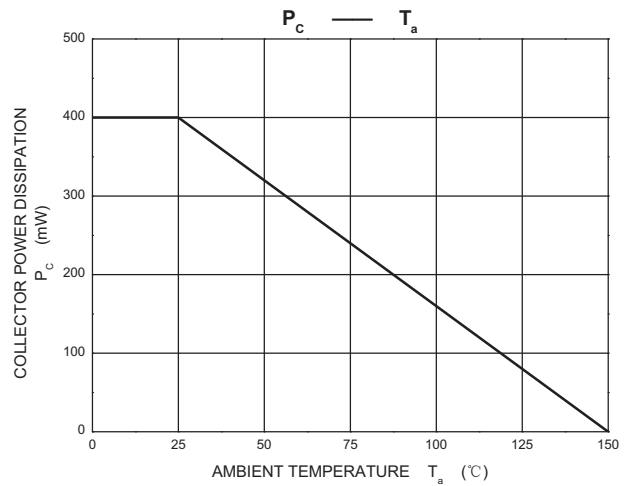
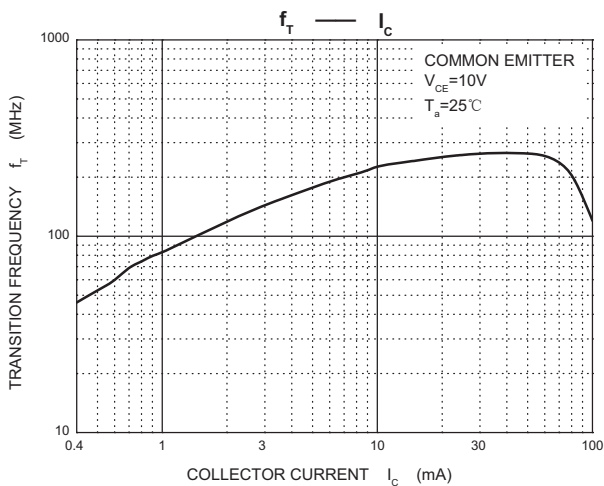
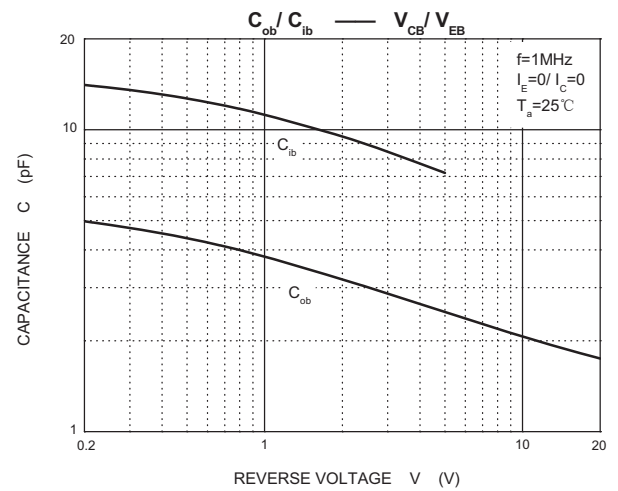
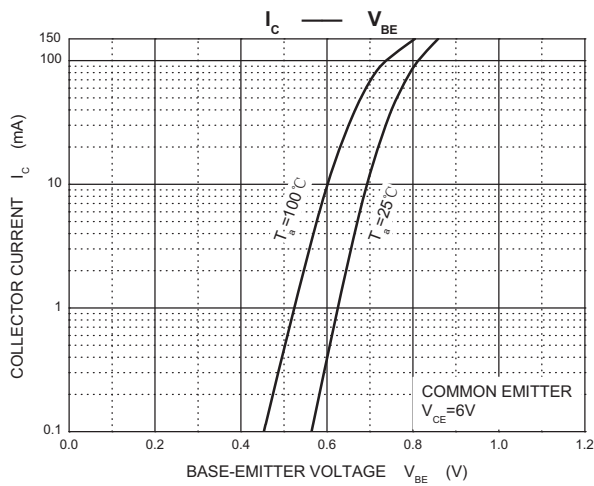
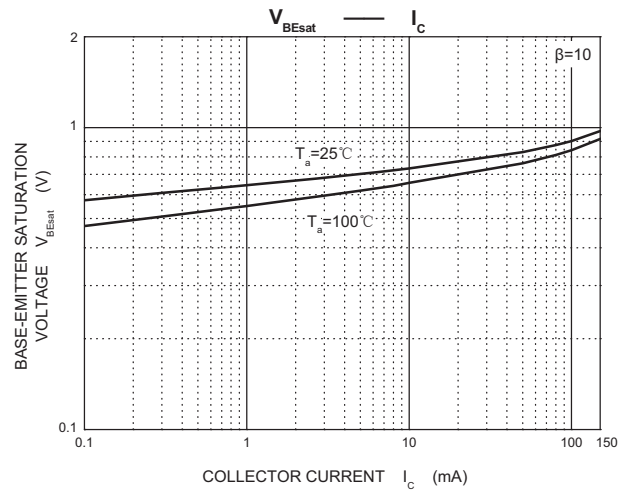
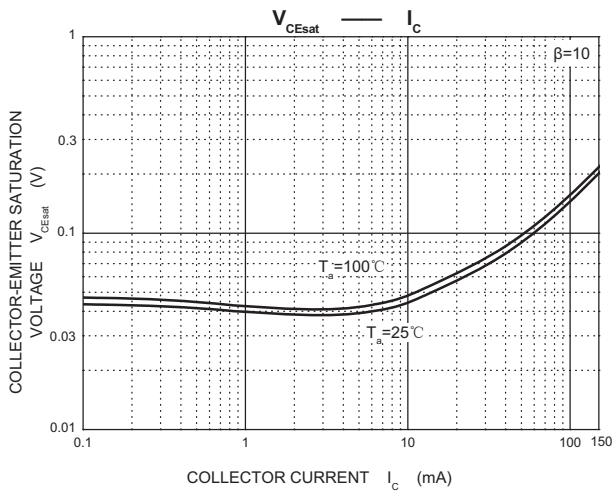
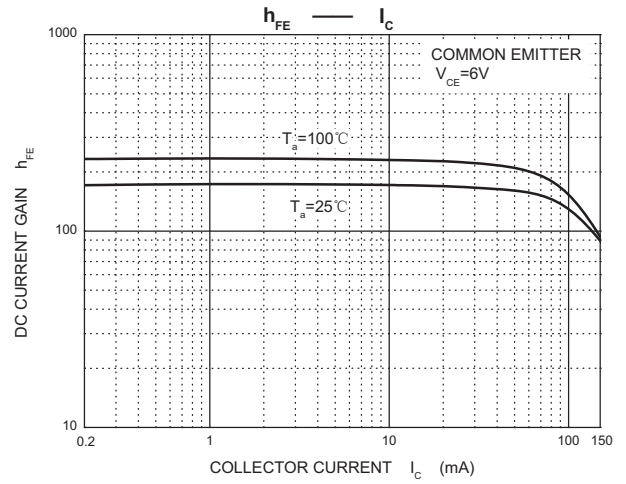
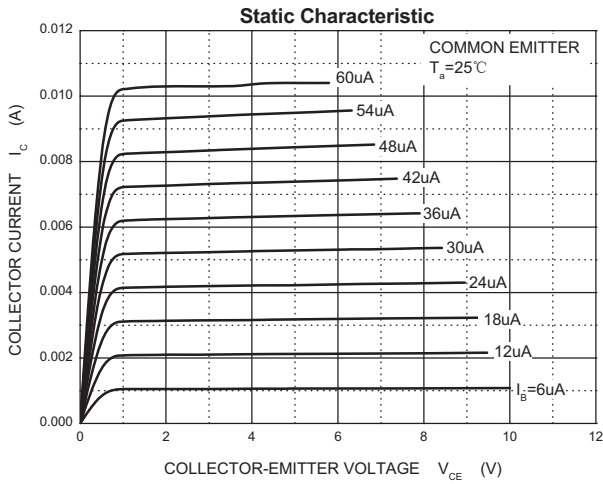

TO-92 Package Outline Dimensions

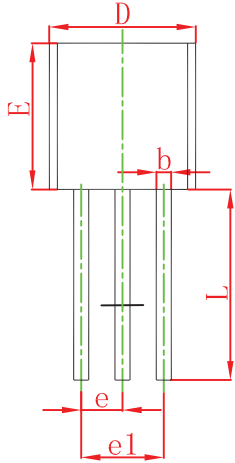
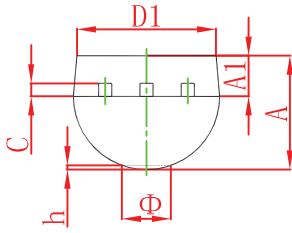

| Symbol | Dimensions In Millimeters | | Dimensions In Inches | |
|--------|---------------------------|--------|----------------------|-------|
| | Min | Max | Min | Max |
| A | 3.300 | 3.700 | 0.130 | 0.146 |
| A1 | 1.100 | 1.400 | 0.043 | 0.055 |
| b | 0.380 | 0.550 | 0.015 | 0.022 |
| c | 0.360 | 0.510 | 0.014 | 0.020 |
| D | 4.300 | 4.700 | 0.169 | 0.185 |
| D1 | 3.430 | | 0.135 | |
| E | 4.300 | 4.700 | 0.169 | 0.185 |
| e | 1.270 TYP | | 0.050 TYP | |
| e1 | 2.440 | 2.640 | 0.096 | 0.104 |
| L | 14.100 | 14.500 | 0.555 | 0.571 |
| Φ | | 1.600 | | 0.063 |
| h | 0.000 | 0.380 | 0.000 | 0.015 |

TO-92 Suggested Pad Layout

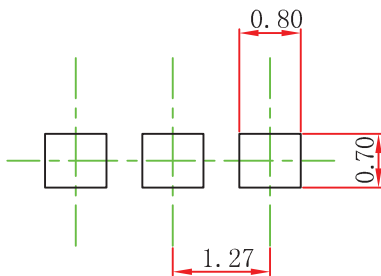

Note:

1. Controlling dimension: in millimeters.
2. General tolerance: $\pm 0.05\text{mm}$.
3. The pad layout is for reference purposes only.

NOTICE

JCET reserve the right to make modifications, enhancements, improvements, corrections or other changes without further notice to any product herein. JCET does not assume any liability arising out of the application or use of any product described herein.

TO-92 PACKAGE TAPEING DIMENSION

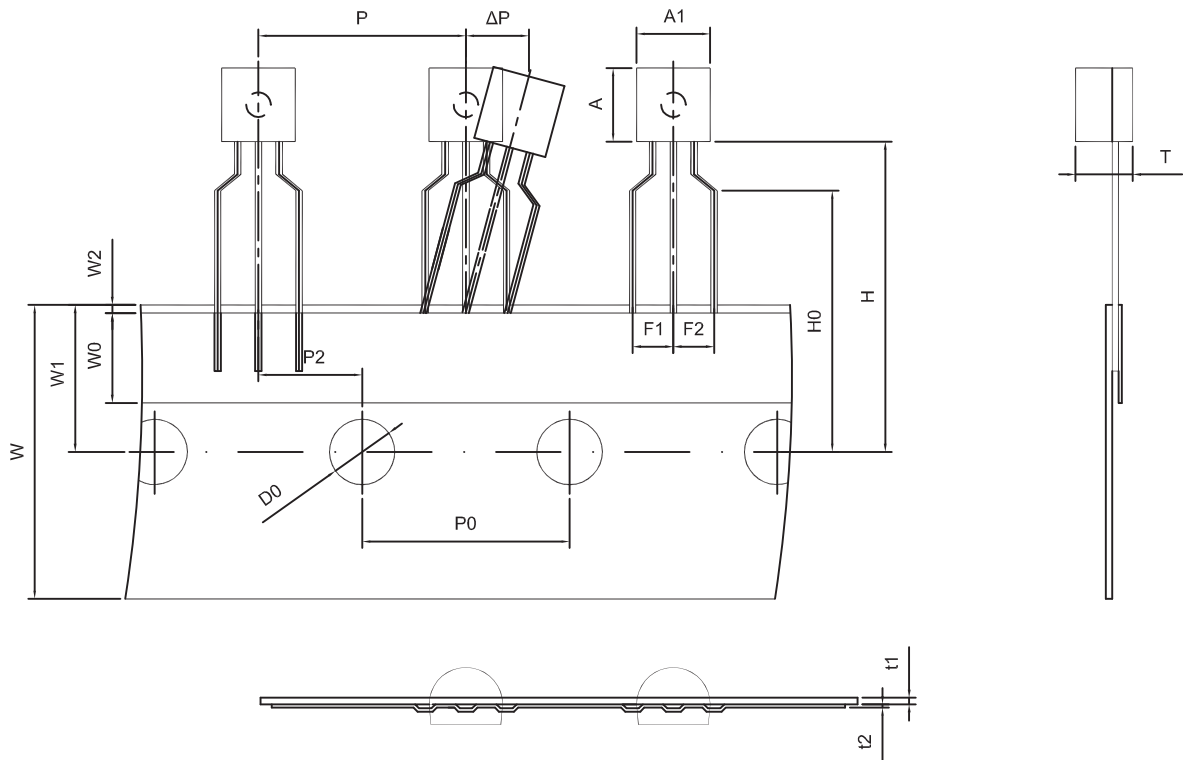

| Dimiensions are in millimeter | | | | | | | | |
|-------------------------------|-----|----------|------|------|------|-----|-----|------|
| A1 | A | T | P | P0 | P2 | F1 | F2 | W |
| 4.5 | 4.5 | 3.5 | 12.7 | 12.7 | 6.35 | 2.5 | 2.5 | 18.0 |
| W0 | W1 | W2 | H | H0 | D0 | t1 | t2 | ΔP |
| 6.0 | 9.0 | 1.0 MAX. | 19.0 | 16.0 | 4.0 | 0.4 | 0.2 | 0 |

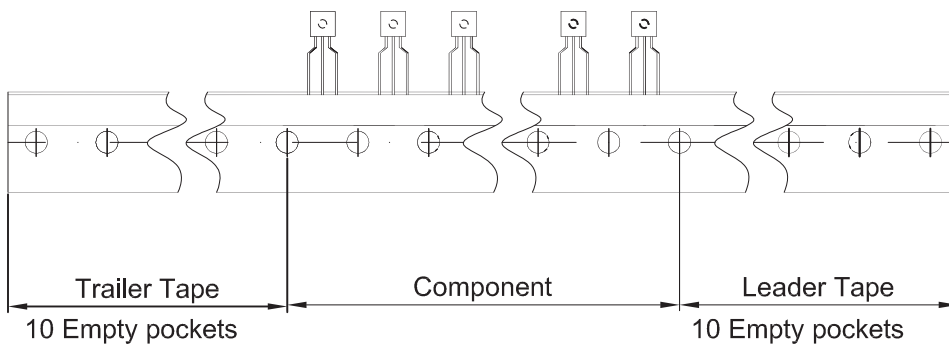

| Package | Box | Box Size(mm) | Carton | Carton Size(mm) |
|---------|----------|--------------|------------|-----------------|
| TO-92 | 2000 pcs | 333×162×43 | 20,000 pcs | 350×340×250 |