



WS/WE24-2B430

W24-2

PHOTOELECTRIC SENSORS

SICK
Sensor Intelligence.



Illustration may differ



Ordering information

Type	Part no.
WS/WE24-2B430	1017853

Other models and accessories → www.sick.com/W24-2

Detailed technical data

Features

Sensor/ detection principle	Through-beam photoelectric sensor
Dimensions (W x H x D)	27 mm x 87.5 mm x 65 mm
Housing design (light emission)	Rectangular
Sensing range max.	0 m ... 60 m
Sensing range	0 m ... 50 m
Type of light	Visible red light
Light source	LED ¹⁾
Light spot size (distance)	Ø 700 mm (50 m)
Angle of dispersion	Approx. 1°
Adjustment	Potentiometer
Time type	On delay Off delay
Delay time	Adjustable via time delay selector switch, 0.5 s, 10 s

¹⁾ Average service life: 100,000 h at T_J = +25 °C.

Communication interface

Communication interface	-
--------------------------------	---

Mechanics/electronics

Supply voltage	10 V DC ... 30 V DC ¹⁾
-----------------------	-----------------------------------

¹⁾ Limit values when operated in short-circuit protected network: max. 8 A.

²⁾ May not exceed or fall below U_V tolerances.

³⁾ Without load.

⁴⁾ Signal transit time with resistive load.

⁵⁾ With light/dark ratio 1:1.

⁶⁾ A = V_S connections reverse-polarity protected.

⁷⁾ C = interference suppression.

⁸⁾ D = outputs overcurrent and short-circuit protected.

⁹⁾ Reference voltage: 50 V DC.

Ripple	< 5 V _{pp} ²⁾
Power consumption, sender	50 mA ³⁾
Power consumption, receiver	40 mA ³⁾
Output type	NPN PNP
Switching mode	Light/dark switching
Switching mode selector	Selectable via PNP/NPN selector, selectable via light/dark selector
Output current I_{max.}	100 mA
Response time	≤ 500 μs ⁴⁾
Switching frequency	1,000 Hz ⁵⁾
Angle of reception	Approx. 2.5°
Connection type	Male connector M12, 4-pin
Circuit protection	A ⁶⁾ C ⁷⁾ D ⁸⁾
Protection class	II ⁹⁾
Weight	660 g
Housing material	Metal, Zinc diecast
Optics material	Plastic, PMMA
Enclosure rating	IP69K
Test input sender off	TE to 0 V
Ambient operating temperature	-40 °C ... +60 °C
Ambient storage temperature	-40 °C ... +75 °C
UL File No.	NRKH.E181493 & NRKH7.E181493
Part number of individual components	2021144 WS24-2D430 2021145 WE24-2B430

1) Limit values when operated in short-circuit protected network: max. 8 A.

2) May not exceed or fall below U_v tolerances.

3) Without load.

4) Signal transit time with resistive load.

5) With light/dark ratio 1:1.

6) A = V_S connections reverse-polarity protected.

7) C = interference suppression.

8) D = outputs overcurrent and short-circuit protected.

9) Reference voltage: 50 V DC.

Classifications

ECl@ss 5.0	27270901
ECl@ss 5.1.4	27270901
ECl@ss 6.0	27270901
ECl@ss 6.2	27270901
ECl@ss 7.0	27270901
ECl@ss 8.0	27270901
ECl@ss 8.1	27270901
ECl@ss 9.0	27270901

ETIM 5.0	EC002716
ETIM 6.0	EC002716
UNSPSC 16.0901	39121528

Adjustments possible

WT24-2, WL24-2, WS/WE24-2, DC

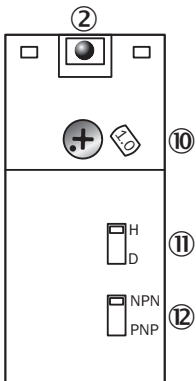

- ② LED signal strength indicator
- ⑩ Adjustment sensing range (WT) / sensitivity (WL, WS/WE)
- ⑪ Light/dark selector
- ⑫ NPN/PNP changeover switch

Connection diagram

Cd-118

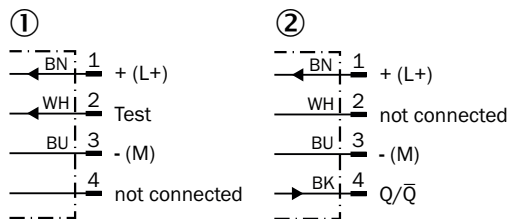

- ① Sender
- ② Receiver

Characteristic curve

WS/WE24-2

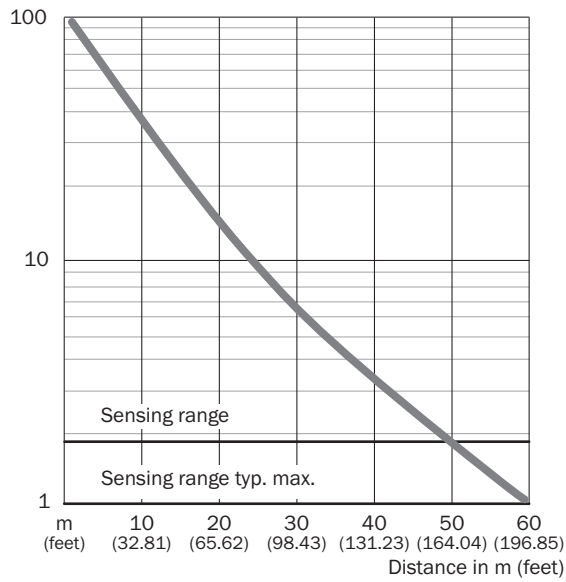

Sensing range diagram

WS/WE24-2

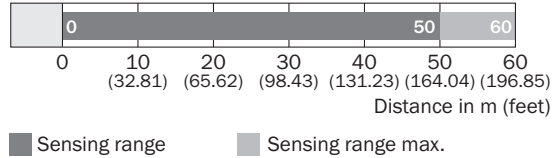

Dimensional drawing (Dimensions in mm (inch))



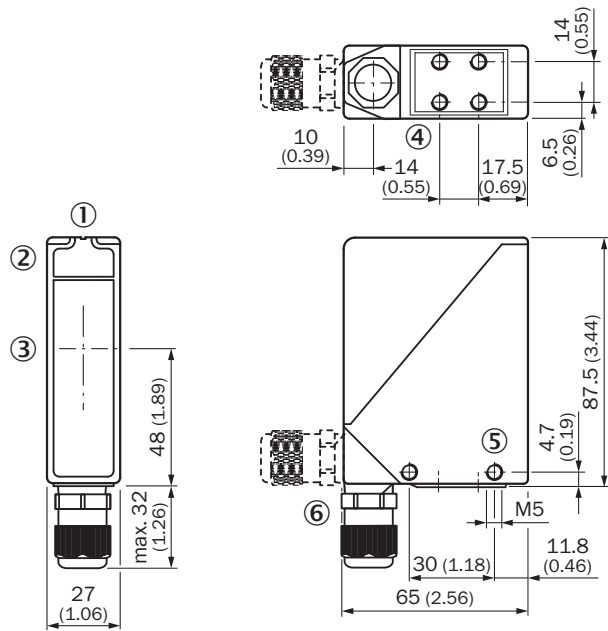

WS/WE24-2



- ① Alignment sight
- ② LED signal strength indicator
- ③ Center of optical axis
- ④ M5 threaded mounting hole, 6 mm deep
- ⑤ M5 threaded mounting hole, through-hole
- ⑥ M16 screw fixing and plug rotatable by 90°

Recommended accessories

Other models and accessories → www.sick.com/W24-2

	Brief description	Type	Part no.
Universal bar clamp systems			
	Universal bar clamp for mounting bars with 12 mm diameter, Zinc diecast, without mounting plate and screws	BEF-KHS-KH3	5322626
	Plate N04 for universal clamp, steel, Zinc plated steel (sheet), Zinc die cast (clamping bracket), Universal clamp (5322626), mounting hardware	BEF-KHS-N04	2051610
Device protection (mechanical)			
	Water cooling plate	BEF-KP-W24	2015071
	Dust protection tube, air-purged, Aluminum (anodised), mounting hardware included	OBS-W24	2015069
	Weather hood for universal clamp bracket, steel, zinc coated, mounting hardware included	OBW-KHS-M01	2023240

	Brief description	Type	Part no.
	Weather hood, Aluminum (anodised), mounting hardware included	OBW-W24	2015070
		WSG1-01	1018470
Mounting brackets and plates			
	Mounting bracket, small, Stainless steel, without mounting hardware	BEF-WK-W24	4027532
	Mounting bracket, Stainless steel (1.4301), mounting hardware included	BEF-WN-W24	2015248
Plug connectors and cables			
	Head A: female connector, M12, 4-pin, straight Head B: cable Cable: PVC, unshielded, 2 m	DOL-1204-G02M	6009382
	Head A: female connector, M12, 4-pin, straight Head B: cable Cable: drag chain use, PUR, halogen-free, unshielded, 2 m	DOL-1204-G02MC	6025900
	Head A: female connector, M12, 4-pin, straight Head B: cable Cable: drag chain use, PUR, halogen-free, unshielded, 5 m	DOL-1204-G05MC	6025901
	Head A: female connector, M12, 4-pin, angled Head B: cable Cable: PVC, unshielded, 2 m	DOL-1204-W02M	6009383
	Head A: female connector, M12, 4-pin, angled Head B: cable Cable: drag chain use, PUR, halogen-free, unshielded, 2 m	DOL-1204-W02MC	6025903
	Head A: female connector, M12, 4-pin, angled Head B: cable Cable: drag chain use, PUR, halogen-free, unshielded, 5 m	DOL-1204-W05MC	6025904
	Head A: female connector, M12, 4-pin, straight Head B: - Cable: unshielded	DOS-1204-G	6007302
	Head A: female connector, M12, 4-pin, angled Head B: - Cable: unshielded	DOS-1204-W	6007303
Alignment aids			
	Adapter for alignment aid AR60	Adapter AR60 for W24-2	4032976

SICK AT A GLANCE

SICK is one of the leading manufacturers of intelligent sensors and sensor solutions for industrial applications. A unique range of products and services creates the perfect basis for controlling processes securely and efficiently, protecting individuals from accidents and preventing damage to the environment.

We have extensive experience in a wide range of industries and understand their processes and requirements. With intelligent sensors, we can deliver exactly what our customers need. In application centers in Europe, Asia and North America, system solutions are tested and optimized in accordance with customer specifications. All this makes us a reliable supplier and development partner.

Comprehensive services complete our offering: SICK LifeTime Services provide support throughout the machine life cycle and ensure safety and productivity.

For us, that is “Sensor Intelligence.”

WORLDWIDE PRESENCE:

Contacts and other locations –www.sick.com