







THT Integrated Common Mode and Differential Mode Choke

PA4040.XXXNL



-  Common Mode and Differential Mode Choke intergrated into a single component reducing overall losses and reducing footprint
-  Dielectric Strength: 1500Vrms
-  Common Mode Inductance: 4.5mH (1Arms) to 0.28mH (3.5Arms)
-  Differential Mode Inductance: 685uH (1.33Apk) to 55uH (4.6Apk)
-  Size (LxWxH): 31.0mm x 24.9mm x 16.5 mm Max
-  Safety Spacing: 3.0mm creepage and clearance between windings, 1.5mm between windings and core

Electrical Specifications @ 25°C - Operating Temperature -40°C to +125°C

Pulse PN	Common Mode Inductance (mH Min) (1-2)=(4-3)	Differential Mode Inductance (uH Min) (1-4 with 2,3 shorted)	I _{rms} (A)	I _{peak} (A)	DCR/winding (mΩ Max) (1-2)=(4-3)	SRF (MHz, typical)	Impedance at SRF (kΩ typical)
PA4040.001NL	4.5	685	1.0	1.33	245	0.5	140
PA4040.002NL	1.25	320	1.5	2	120	0.7	47
PA4040.003NL	0.41	96	2.5	3.33	46	1.45	8.5
PA4040.004NL	0.28	55	3.5	4.6	32	1.75	5.3

- Notes:**
- The current rating (I_{rms}) is based upon the temperature rise of the component and represents the rms current which will cause a typical temperature rise of 40°C.
 - The peak current is the current which will typically cause a 20% drop in the differential mode inductance. The peak current should not be exceeded in the application as it will reduce the CM and DM rejection of the component.
 - The temperature of the component (ambient plus temperature rise) must be within the stated operating temperature range.
 - The PA4040.XXXNL is designed to provide 3.0mm of safety spacing (creepage and clearance distance) between windings and 1.5mm of safety spacing (creepage and clearance distance) between both windings and core.

THT Integrated Common Mode and Differential Mode Choke

PA4040.XXXNL

Mechanical

PA4040.XXXNL

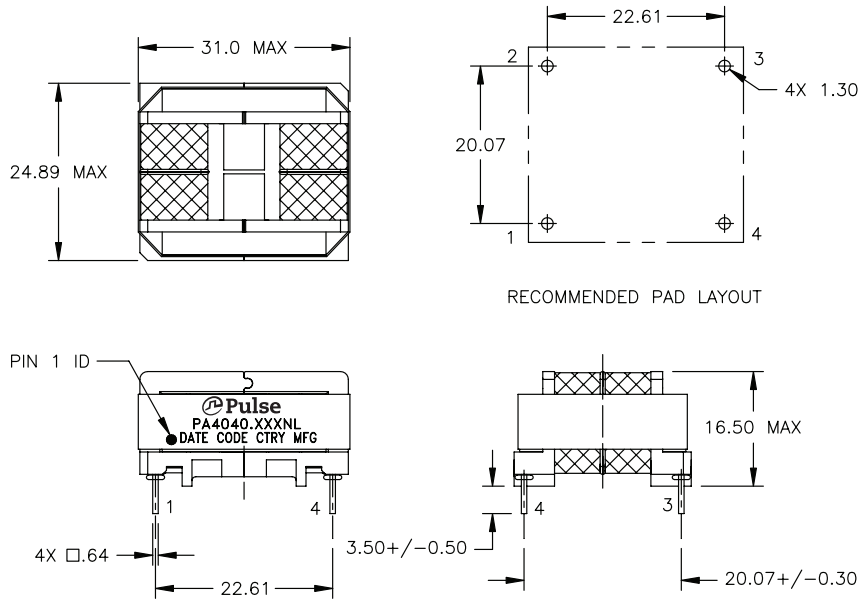

Schematic

PA4040.XXXNL

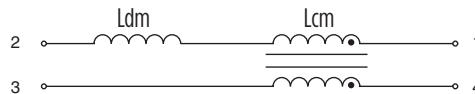

For More Information

Pulse Worldwide Headquarters
12220 World Trade Drive
San Diego, CA
92128
U.S.A.

Pulse Europe
Zeppelinstrasse 15
71083 Herrenberg
Germany

Pulse China Headquarters
B402, Shenzhen Academy of
Aerospace Technology Bldg.
10th Kejian Road
High-Tech Zone
Nanshan District
Shenzhen, PR China
518057
Tel: 86 755 33966678
Fax: 86 755 33966700

Pulse North China
Room 2704/2705
Super Ocean Finance
Ctr.
2067 Yan An Road
West
Shanghai 200336
China
Tel: 86 21 62787060

Pulse South Asia
135 Joo Seng Road
#03-02
PM Industrial Bldg.
Singapore 368363

Tel: 65 6287 8998
Fax: 65 6287 8998

Pulse North Asia
3F, No. 198
Zhongyuan Road
Zhongli City
Taoyuan County 320
Taiwan R. O. C.
Tel: 886 3 4356768
Fax: 886 3 4356823
(Pulse)

Tel: 858 674 8100
Fax: 858 674 8262

Tel: 49 7032 7806 0
Fax: 49 7032 7806 12

Performance warranty of products offered on this data sheet is limited to the parameters specified. Data is subject to change without notice. Other brand and product names mentioned herein may be trademarks or registered trademarks of their respective owners. © Copyright, 2014. Pulse Electronics, Inc. All rights reserved.