

General Description

The MAX16052/MAX16053 are a family of small, low-power, high-voltage monitoring circuits with sequencing capability. These miniature devices offer very wide flexibility with an adjustable voltage threshold and an external capacitor-adjustable time delay. These devices are ideal for use in power-supply sequencing, reset sequencing, and power switching applications. Multiple devices can be cascaded for complex sequencing applications.

A high-impedance input (IN) with a 0.5V threshold allows an external resistive-divider to set the monitored threshold. The output (OUT) asserts high when the input voltage rises above the 0.5V threshold and the enable input (EN) is asserted high. When the voltage at IN falls below 0.495V or when the enable input is de-asserted (EN = low), the output deasserts (OUT = low). The devices provide a capacitor programmable delay time from when the voltage at IN rises above 0.5V to when the output is asserted.

The MAX16052 offers an active-high open-drain output while the MAX16053 offers an active-high push-pull output. Both devices operate from a 2.25V to 28V supply voltage and feature an active-high enable input. The MAX16052/MAX16053 are available in a tiny 6-pin SOT23 package and are fully specified over the automotive temperature range (-40°C to +125°C).

Benefits and Features

- Less External Circuitry Results in Smaller Solution Size
 - Open-Drain (28V Tolerant) Output Allows Interfacing to 12V Intermediate Bus Voltage
 - Operates from V_{CC} of 2.25V to 28V
 - Small 6-Pin SOT23 Package
- Ideal for Use in Power-Supply Sequencing, Reset Sequencing, and Power-Switching Applications
 - Active-High Logic-Enable Input
 - 1.8% Accurate Adjustable Threshold Over Temperature
- Fully Specified from -40°C to +125°C for Reliability in Extreme Temperatures
- Low Supply Current (18µA typ) Reduces Power Consumption

Applications

- Medical Equipment
- Intelligent Instruments
- Portable Equipment
- Computers/Servers
- Critical µP Monitoring
- Set-Top Boxes
- Telecom

Typical Operating Circuit

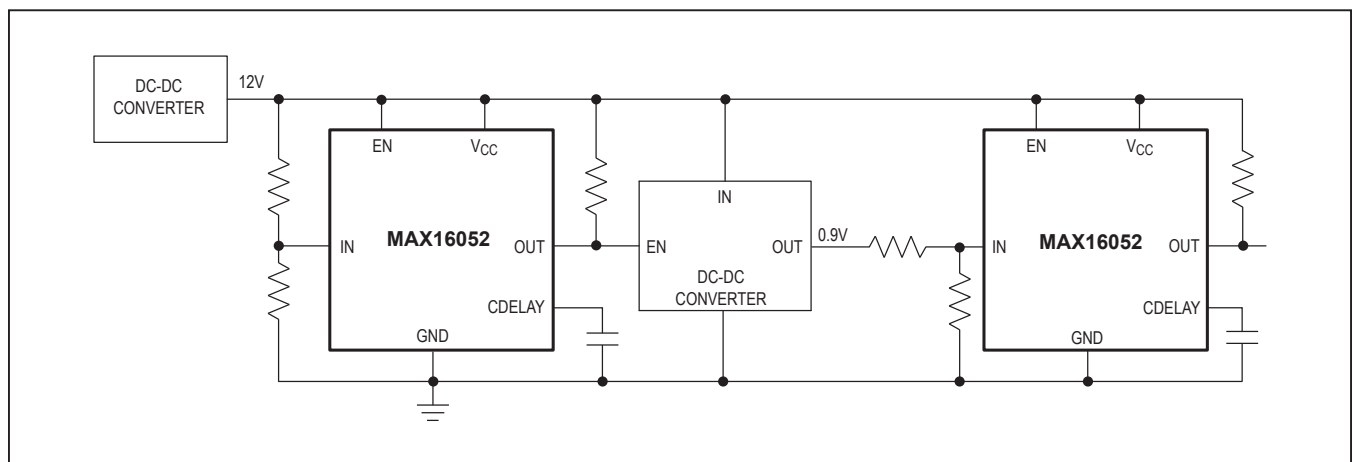

Absolute Maximum Ratings

(All voltages referenced to GND.)

V _{CC}	-0.3V to +30V
OUT (push-pull, MAX16053).....	-0.3V to (V _{CC} + 0.3V)
OUT (open-drain, MAX16052).....	-0.3V to +30V
EN, IN	-0.3V to (V _{CC} + 0.3V)
CDELAY.....	-0.3V to +6V
Input/Output Current (all pins).....	±20mA

Continuous Power Dissipation (T _A = +70°C)	
6-Pin SOT23 (derate 8.7mW/°C above +70°C).....	695.7mW
Operating Temperature Range	-40°C to +125°C
Junction Temperature.....	+150°C
Storage Temperature Range	-65°C to +150°C
Lead Temperature (soldering, 10s)	+300°C
Soldering Temperature (reflow)	+260°C

Stresses beyond those listed under "Absolute Maximum Ratings" may cause permanent damage to the device. These are stress ratings only, and functional operation of the device at these or any other conditions beyond those indicated in the operational sections of the specifications is not implied. Exposure to absolute maximum rating conditions for extended periods may affect device reliability.

Electrical Characteristics

(V_{CC} = 2.25V to 28V, V_{EN} = V_{CC}, T_A = T_J = -40°C to +125°C, unless otherwise specified. Typical values are at V_{CC} = 3.3V and T_A = +25°C.) (Note 1)

PARAMETER	SYMBOL	CONDITIONS	MIN	TYP	MAX	UNITS
SUPPLY						
Operating Voltage Range	V _{CC}		2.25		28	V
Undervoltage Lockout	UVLO	V _{CC} falling (Note 2)	1.8		2	V
V _{CC} Supply Current	I _{CC}	MAX16052, no load	V _{CC} = 3.3V	18	37	µA
			V _{CC} = 12V	23	45	
			V _{CC} = 28V	38	61	
		MAX16053, no load	V _{CC} = 3.3V	22	47	
			V _{CC} = 12V	29	57	
			V _{CC} = 28V	44	71	
IN						
Threshold Voltage	V _{TH}	V _{IN} rising, 2.25V ≤ V _{CC} ≤ 28V	0.491	0.500	0.509	V
Hysteresis	V _{HYST}	V _{IN} falling		5		mV
Input Current	I _{IN}	V _{IN} = 0 or 28V	-110	+25	+110	nA
CDELAY						
CDELAY Charge Current	I _{CD}	V _{CDELAY} = 0V	200	250	300	nA
CDELAY Threshold	V _{TCD}	V _{CDELAY} rising	0.95	1.00	1.05	V
CDELAY Pulldown Resistance	R _{CDELAY}	V _{CC} ≥ 2.25V, I _{SINK} = 200µA		15	60	Ω
		V _{CC} ≥ 3.3V, I _{SINK} = 1mA		15	60	
EN						
EN Low Voltage	V _{IL}				0.5	V
EN High Voltage	V _{IH}		1.4			V
EN Leakage Current	I _{LEAK}	V _{EN} = 0 or 28V	-110	+20	+110	nA
OUT						
OUT Low Voltage (Open-Drain or Push-Pull)	V _{OL}	V _{CC} ≥ 1.2V, I _{SINK} = 90µA			0.2	V
		V _{CC} ≥ 2.25V, I _{SINK} = 0.5mA			0.3	
		V _{CC} > 4.5V, I _{SINK} = 1mA			0.4	
OUT High Voltage (Push-Pull, MAX16053)	V _{OH}	V _{CC} ≥ 2.25V, I _{SOURCE} = 500µA	0.8 × V _{CC}			V
		V _{CC} ≥ 4.5V, I _{SOURCE} = 800µA	0.9 × V _{CC}			
OUT Leakage Current (Open-Drain, MAX16052)	I _{LKG}	Output not asserted low, V _{OUT} = 28V			150	nA

Electrical Characteristics (continued)

(V_{CC} = 2.25V to 28V, V_{EN} = V_{CC}, T_A = T_J = -40°C to +125°C, unless otherwise specified. Typical values are at V_{CC} = 3.3V and T_A = +25°C.) (Note 1)

PARAMETER	SYMBOL	CONDITIONS		MIN	TYP	MAX	UNITS
TIMING							
IN to OUT Propagation Delay	t _{DELAY}	V _{CC} = 3.3V, V _{IN} rising, V _{IN} = V _{TH} + 25mV	MAX16052, 100kΩ pullup resistor, C _{CDELAY} = 0		30		μs
			MAX16053, C _{CDELAY} = 0		30		
			MAX16052, 100kΩ pullup resistor, C _{CDELAY} = 0.047μF		190		ms
			MAX16053, C _{CDELAY} = 0.047μF		190		
	V _{CC} = 12V, V _{IN} rising, V _{IN} = V _{TH} + 25mV	MAX16052, 100kΩ pullup resistor, C _{CDELAY} = 0		30		μs	
		MAX16053, C _{CDELAY} = 0		30			
t _{DL}		V _{CC} = 3.3V, V _{IN} falling, V _{IN} = V _{TH} - 30mV		18			
		V _{CC} = 12V, V _{IN} falling, V _{IN} = V _{TH} - 30mV		18			
Startup Delay (Note 3)		V _{CC} = 2.25V, V _{IN} = 0.525V, C _{CDELAY} = 0		0.5		ms	
		V _{CC} = 12V, V _{IN} = 12V, C _{CDELAY} = 0		0.5			
EN Minimum Input Pulse Width	t _{MPW}			1			μs
EN Glitch Rejection					100		ns
EN to OUT Delay	t _{OFF}	From device enabled to device disabled	MAX16052, 100kΩ pullup resistor	V _{CC} = 3.3V		250	ns
				V _{CC} = 12V		300	
			MAX16053	V _{CC} = 3.3V		350	
				V _{CC} = 12V		400	
EN to OUT Delay	t _{PROP}	From device disabled to device enabled	MAX16052, 100kΩ pullup resistor, C _{CDELAY} = 0	V _{CC} = 3.3V		14	μs
				V _{CC} = 12V		14	
			MAX16053	V _{CC} = 3.3V		14	
				V _{CC} = 12V		14	
			MAX16052, 100kΩ pullup resistor, C _{CDELAY} = 0.047μF		190	ms	
				MAX16053, C _{CDELAY} = 0.047μF			190

Note 1: All devices are production tested at T_A = +25°C. Limits over temperature are guaranteed by design.

Note 2: When V_{CC} falls below the UVLO threshold, the outputs deassert (OUT goes low). When V_{CC} falls below 1.2V, the output state cannot be determined.

Note 3: During the initial power-up, V_{CC} must exceed 2.25V for at least 0.5ms before OUT can go high.

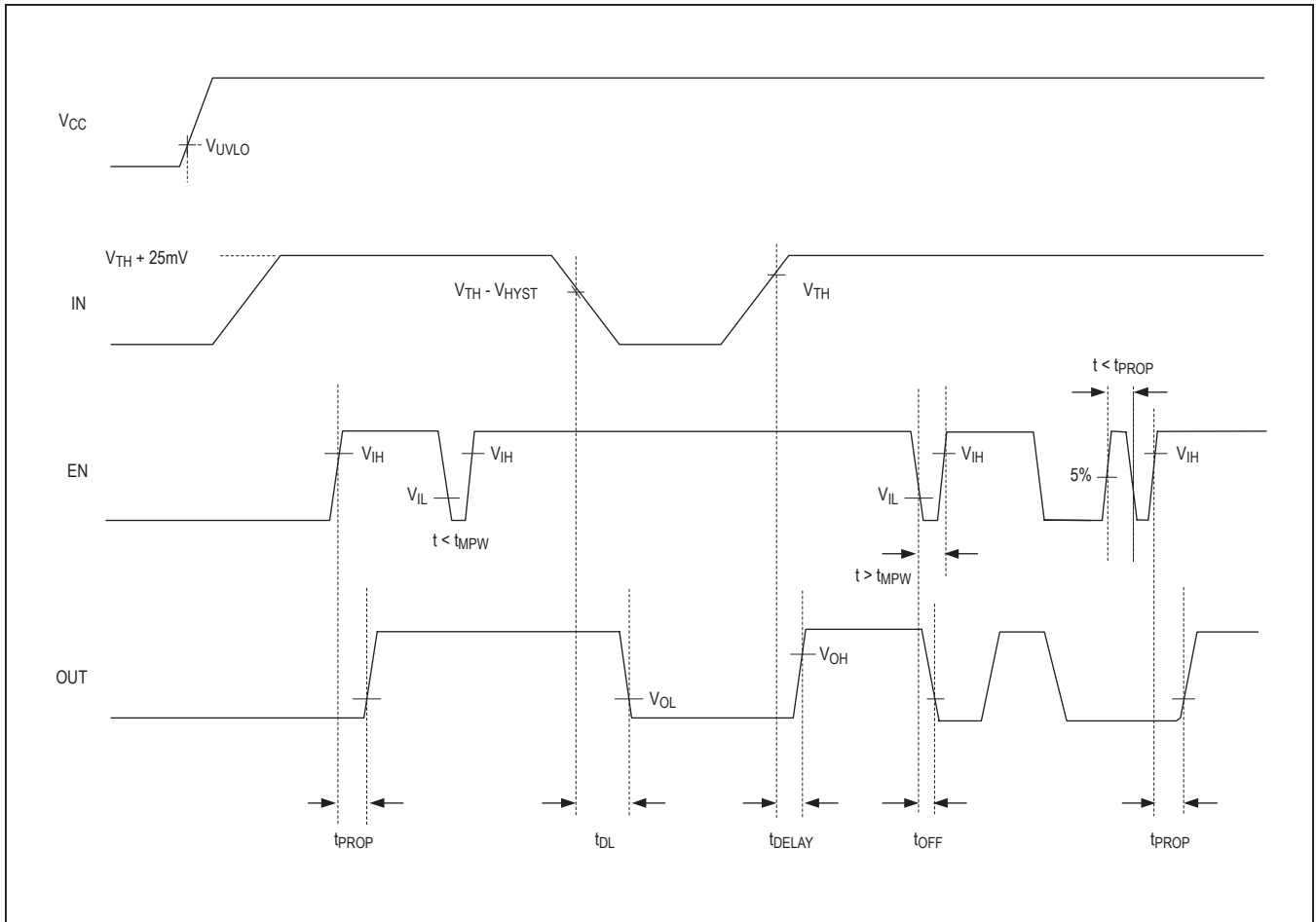
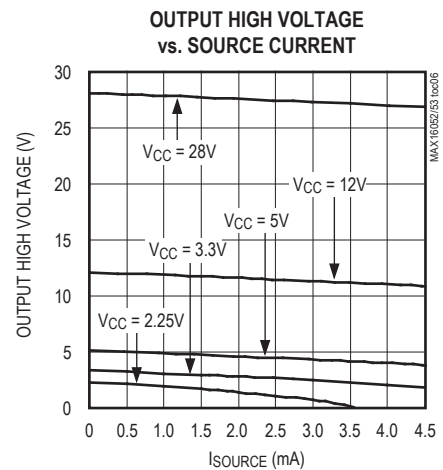
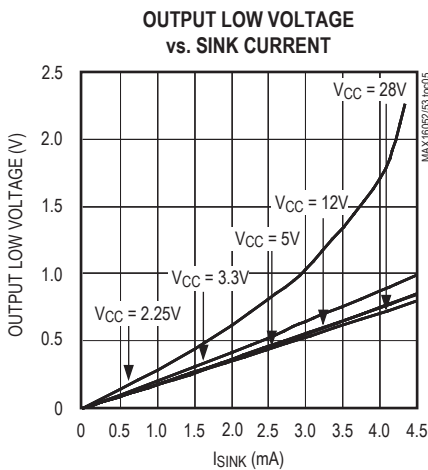
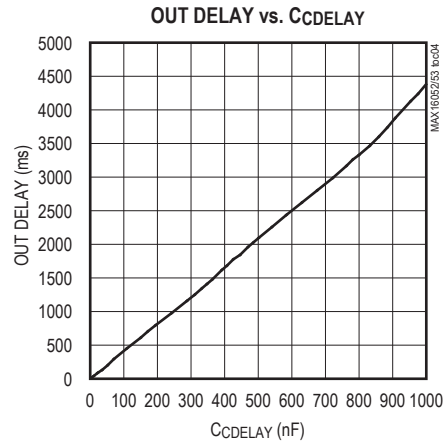
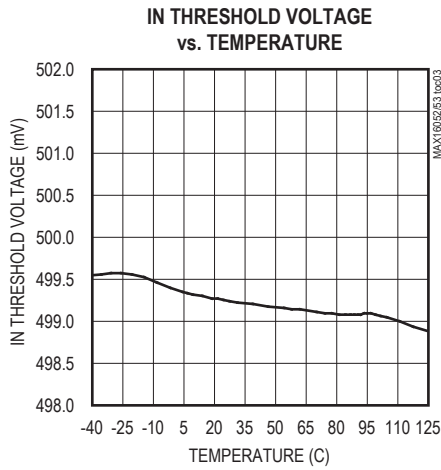
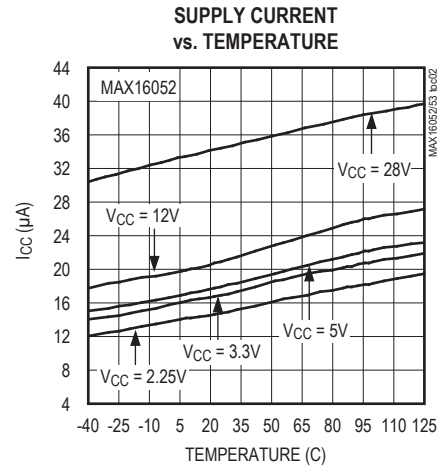
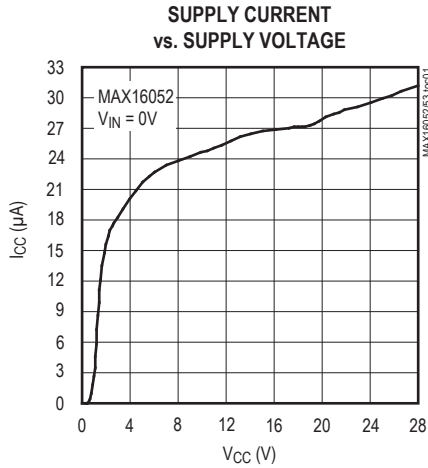

Figure 1. MAX16052/MAX16053 Timing Diagram (C_{DELAY} = 0)

Typical Operating Characteristics

($V_{CC} = 3.3V$ and $T_A = +25^\circ C$, unless otherwise noted.)



Typical Operating Characteristics (continued)

($V_{CC} = 3.3V$ and $T_A = +25^\circ C$, unless otherwise noted.)

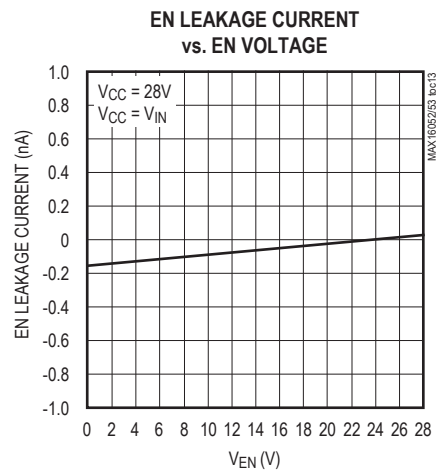
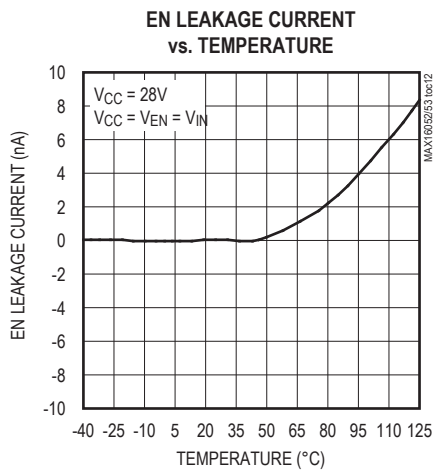
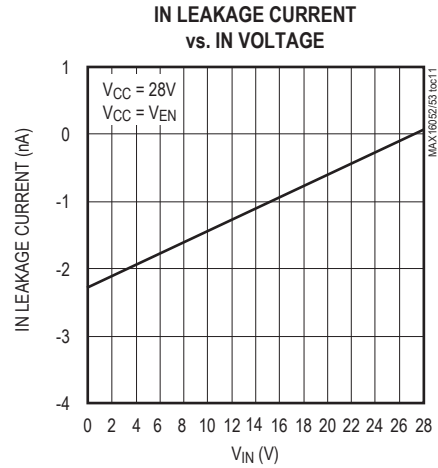
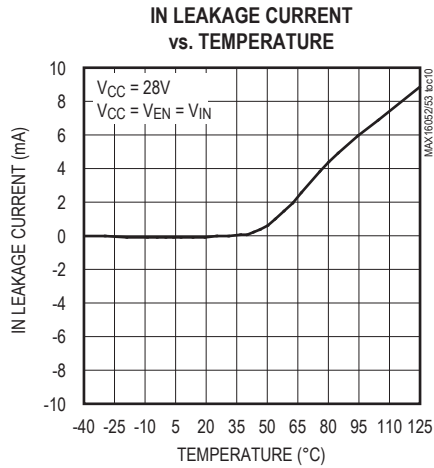
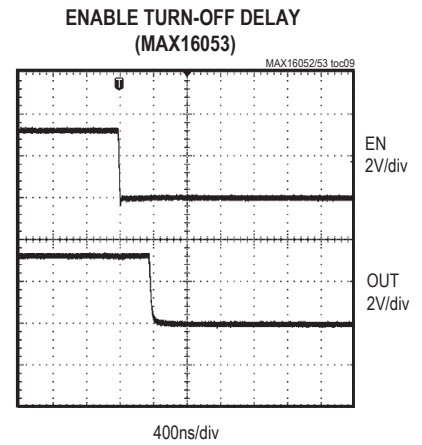
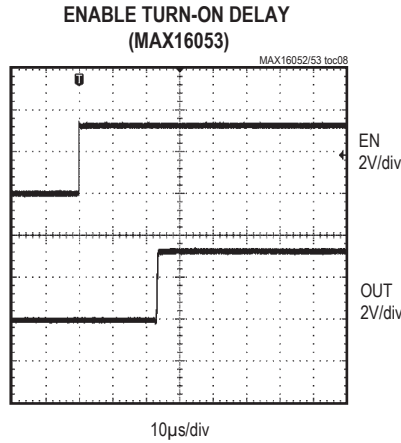
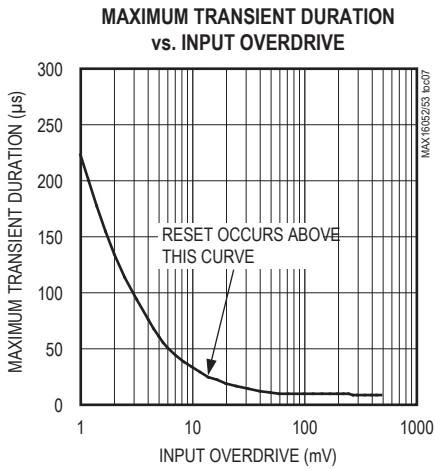

Pin Configuration

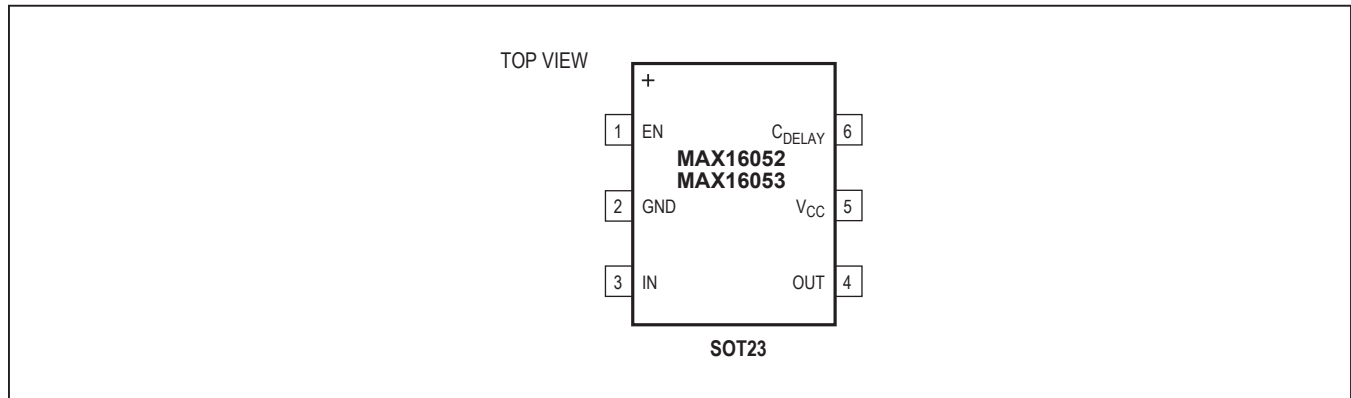

Pin Description

PIN	NAME	FUNCTION
1	EN	Active-High Logic-Enable Input. Drive EN low to immediately de-assert the output to its false state (OUT = low) independent of V_{IN} . With V_{IN} above V_{TH} , drive EN high to assert the output to its true state (OUT = high) after the adjustable delay period. Connect EN to V_{CC} , if not used.
2	GND	Ground
3	IN	High-Impedance Monitor Input. Connect IN to an external resistive-divider to set the desired monitor threshold. The output changes state when V_{IN} rises above 0.5V and when V_{IN} falls below 0.495V.
4	OUT	Active-High Sequencer/Monitor Output. Open-drain (MAX16052) or push-pull (MAX16053). OUT is asserted to its true state (OUT = high) when V_{IN} is above V_{TH} and the enable input is in its true state (EN = high) after the capacitor-adjusted delay period. OUT is de-asserted to its false state (OUT = low) immediately after V_{IN} drops below 0.495V or the enable input is in its false state (EN = low). The MAX16052 open-drain output requires an external pullup resistor.
5	V_{CC}	Supply Voltage Input. Connect a 2.25V to 28V supply to V_{CC} to power the device. For noisy systems, bypass with a 0.1 μ F ceramic capacitor to GND.
6	C_{DELAY}	Capacitor-Adjustable Delay Input. Connect an external capacitor (C_{DELAY}) from C_{DELAY} to GND to set the IN-to-OUT and EN-to-OUT delay period. For V_{IN} rising, $t_{DELAY} = (C_{DELAY} \times 4.0 \times 10^6) + 30\mu s$. For EN rising, $t_{PROP} = (C_{DELAY} \times 4.0 \times 10^6) + 14\mu s$.

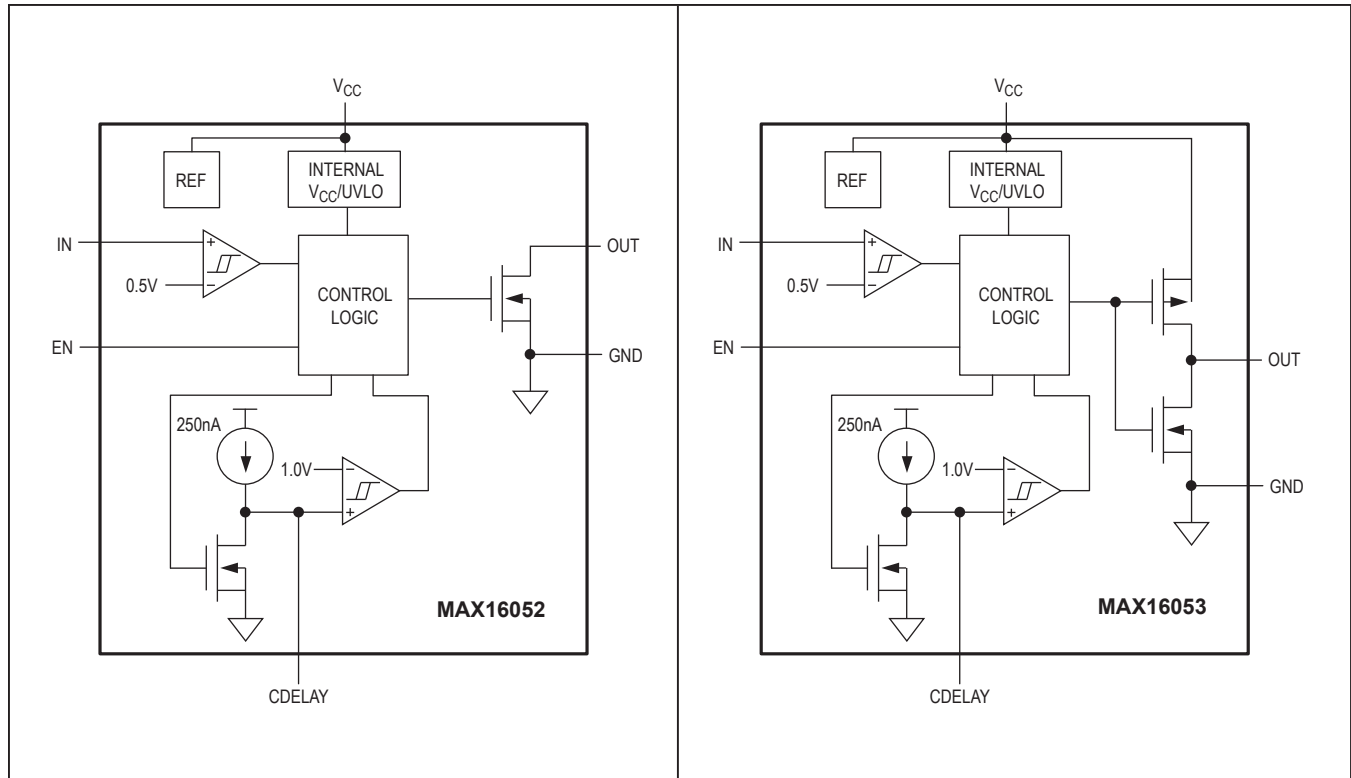

Figure 2. Simplified Functional Diagram

Detailed Description

The MAX16052/MAX16053 family of high-voltage, sequencing/supervisory circuits provide adjustable voltage monitoring for inputs down to 0.5V. These devices are ideal for use in power-supply sequencing, reset sequencing, and power-switching applications. Multiple devices can be cascaded for complex sequencing applications.

The MAX16052/MAX16053 perform voltage monitoring using a high-impedance input (IN) with an internally fixed 0.5V threshold. When the voltage at IN falls below 0.5V or when the enable input is de-asserted (EN = low) OUT goes low. When V_{IN} rises above 0.5V and the enable input is asserted (EN = high), OUT goes high after a capacitor-adjustable time delay.

With V_{IN} above 0.5V, the enable input can be used to turn on or off the output. Table 1 details the output state depending on the various input and enable conditions.

Table 1. MAX16052/MAX16053

IN	EN	OUT
$V_{IN} < V_{TH}$	Low	Low
$V_{IN} < V_{TH}$	High	Low
$V_{IN} < V_{TH}$	Low	Low
$V_{IN} < V_{TH}$	High	OUT = High Impedance (MAX16052)
		OUT = V_{CC} (MAX16053)

Supply Input (VCC)

The device operates with a V_{CC} supply voltage from 2.25V to 28V. In order to maintain a 1.8% accurate threshold at IN, V_{CC} must be above 2.25V. When V_{CC} falls below the UVLO threshold, the output deasserts low. When V_{CC} falls below 1.2V, the output state is not guaranteed. For noisy systems, connect a 0.1µF ceramic capacitor from V_{CC} to GND as close to the device as possible.

Monitor Input (IN)

Connect the center point of a resistive-divider to IN to monitor external voltages (see R1 and R2 of [Figure 4](#)). IN has a rising threshold of $V_{TH} = 0.5V$ and a falling threshold of $0.495V$ (5mV hysteresis). When V_{IN} rises above V_{TH} and EN is high, OUT goes high after the adjustable t_{DELAY} period. When V_{IN} falls below $0.495V$, OUT goes low after a $18\mu s$ delay. IN has a maximum input current of $60nA$, so large value resistors are permitted without adding significant error to the resistive-divider.

Adjustable Delay (CDELAY)

When V_{IN} rises above V_{TH} with EN high, the internal $250nA$ current source begins charging an external capacitor connected from C_{DELAY} to GND. When the voltage at C_{DELAY} reaches $1V$, the output asserts (OUT goes high). When the output asserts, C_{DELAY} is immediately discharged. Adjust the delay (t_{DELAY}) from when V_{IN} rises above V_{TH} (with EN high) to OUT going high according to the equation:

$$t_{DELAY} = C_{DELAY} \times (4 \times 10^6 \Omega) + (30\mu s)$$

where t_{DELAY} is in seconds and C_{DELAY} is in Farads.

Enable Input (EN)

The MAX16052/MAX16053 offer an active-high enable input (EN). With V_{IN} above V_{TH} , drive EN high to force OUT high after the capacitor-adjustable delay time. The EN-to-OUT delay time (t_{PROP}) can be calculated from when EN goes above the EN threshold using the equation:

$$t_{PROP} = C_{DELAY} \times (4 \times 10^6 \Omega) + (14\mu s)$$

where t_{PROP} is in seconds and C_{DELAY} is in Farads. Drive EN low to force OUT low within $300ns$ for the MAX16052 and within $400ns$ for the MAX16053.

Output (OUT)

The MAX16052 offers an active-high, open-drain output while the MAX16053 offers an active-high push-pull output. The push-pull output is referenced to V_{CC} . The open-drain output requires a pullup resistor and can be pulled up to $28V$.

Applications Information

Input Threshold

The MAX16052/MAX16053 monitor the voltage on IN with an external resistive-divider ([Figure 4](#)). R1 and R2 can have very high values to minimize current consumption due to low IN leakage currents ($60nA$ max). Set R2 to

some conveniently high value ($200k\Omega$ for $\pm 1\%$ additional variation in threshold, for example) and calculate R1 based on the desired monitored voltage using the following formula:

$$R1 = R2 \times \left[\frac{V_{MONITOR}}{V_{TH}} - 1 \right]$$

where $V_{MONITOR}$ is the desired monitored voltage and V_{TH} is the reset input threshold ($0.5V$).

Pullup Resistor Values (MAX16052 Only)

The exact value of the pullup resistor for the open-drain output is not critical, but some consideration should be made to ensure the proper logic levels when the device is sinking current. For example, if $V_{CC} = 2.25V$ and the pullup voltage is $28V$, keep the sink current less than $0.5mA$ as shown in the *Electrical Characteristics* table. As a result, the pullup resistor should be greater than $56k\Omega$. For a $12V$ pullup, the resistor should be larger than $24k\Omega$. Note that the ability to sink current is dependent on the V_{CC} supply voltage.

Ensuring a Valid OUT Down to $V_{CC} = 0V$ (Push-Pull OUT)

In applications in which OUT must be valid down to $V_{CC} = 0V$, add a pulldown resistor between OUT and GND for the push-pull output (MAX16053). The resistor sinks any stray leakage currents, holding OUT low ([Figure 3](#)). The value of the pulldown resistor is not critical; $100k\Omega$ is large enough not to load OUT and small enough to pull OUT to ground. The external pulldown cannot be used with the open-drain OUT output.

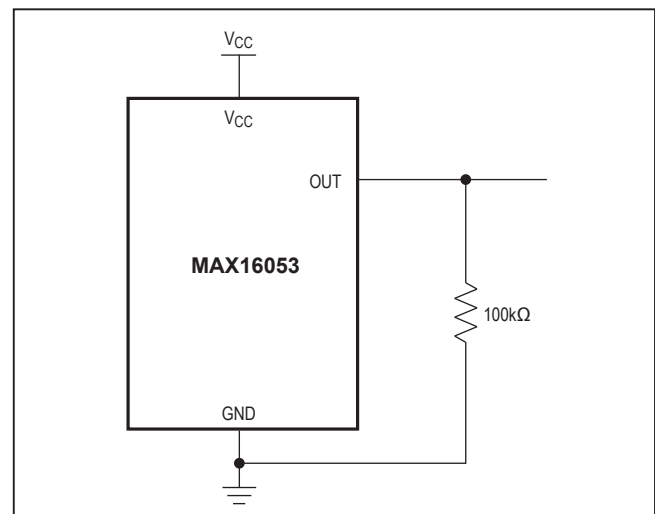

Figure 3. Ensuring OUT Valid to $V_{CC} = 0V$

Typical Application Circuits

Figure 4 through Figure 6 show typical applications for the MAX16052/MAX16053. Figure 4 shows the MAX16052 used with a pMOSFET in an overvoltage protection circuit. Figure 5 shows the MAX16053 in a low-voltage sequencing application using an nMOSFET. Figure 6 shows the MAX16053 used in a multiple output sequencing application.

Using an n-Channel Device for Sequencing

In higher power applications, using an n-channel device reduces the loss across the MOSFET as it offers a lower drain-to-source on-resistance. However, an nMOSFET

requires a sufficient V_{GS} voltage to fully enhance it for a low R_{DS_ON} . The application shown in Figure 5 shows the MAX16053 in a switch sequencing application using an nMOSFET.

Similarly, if a higher voltage is present in the system, the open-drain version can be used in the same manner.

Power-Supply Bypassing

In noisy applications, bypass V_{CC} to ground with a $0.1\mu F$ capacitor as close to the device as possible. The additional capacitor improves transient immunity. For fast-rising V_{CC} transients, additional capacitors may be required.

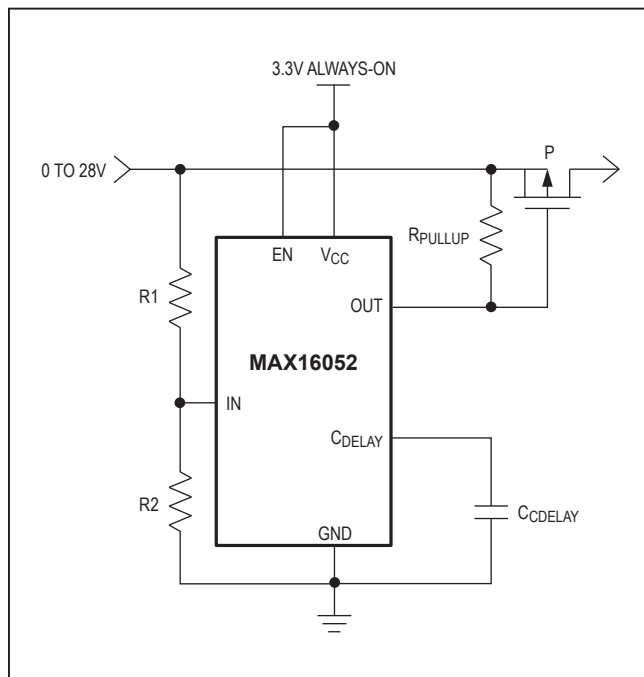

Figure 4. Overvoltage Protection

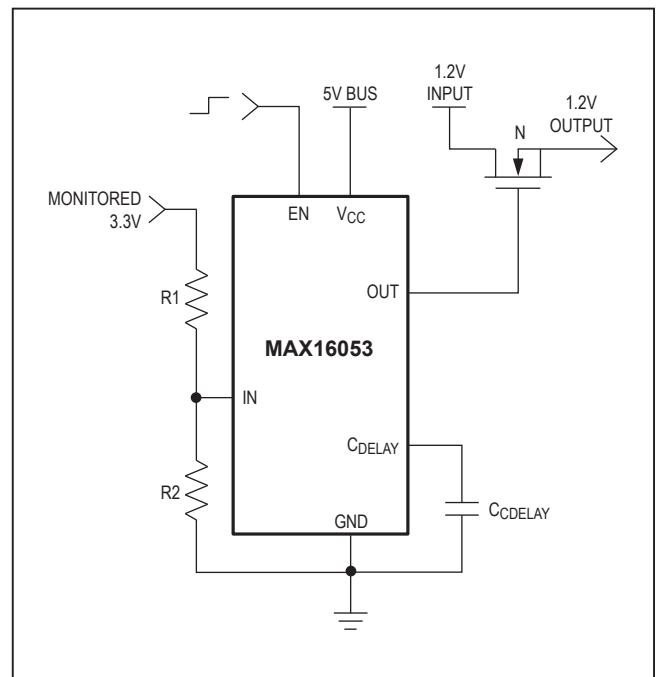

Figure 5. Low-Voltage Sequencing Using an nMOSFET

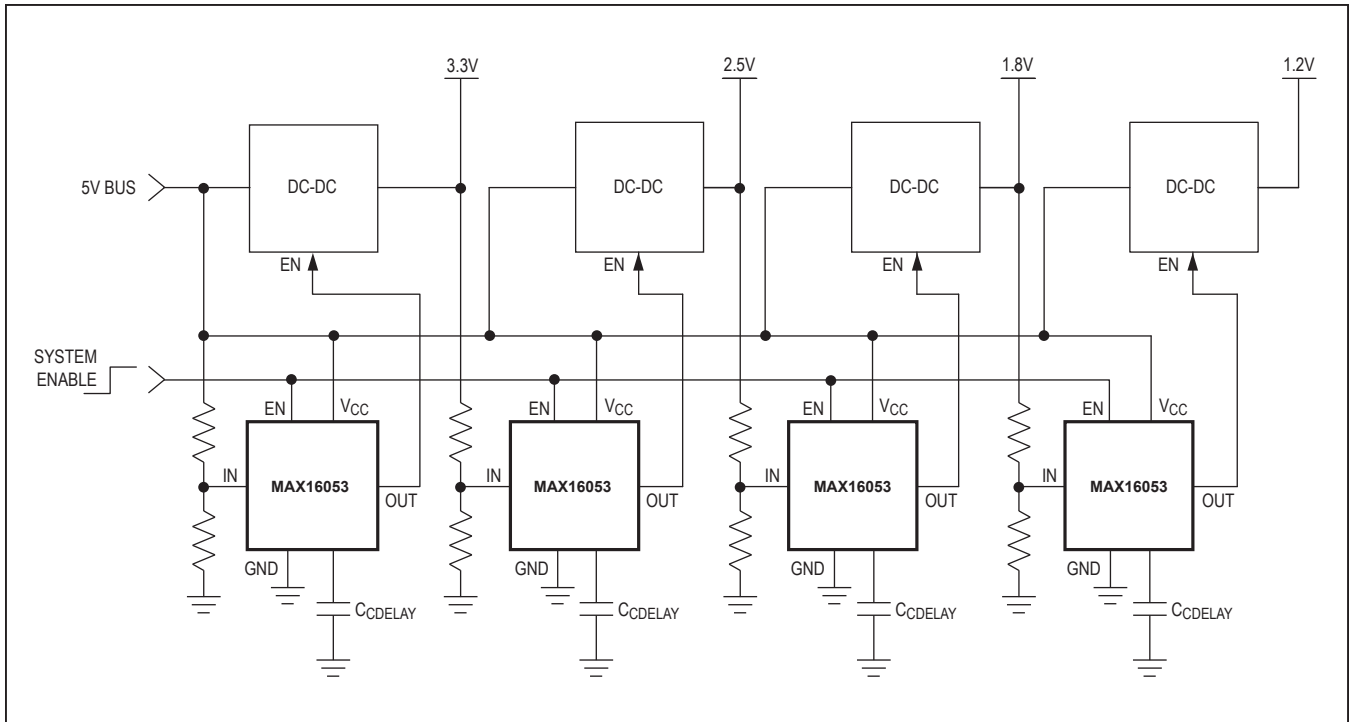

Figure 6. Multiple Output Sequencing

Ordering Information

PART	OUTPUT	PIN-PACKAGE	TOP MARK
MAX16052AUT+T	Open-Drain	6 SOT23	+ACLW
MAX16053AUT+T	Push-Pull	6 SOT23	+ACLX

Note: All devices operate over the -40°C to +125°C operating automotive temperature range.

+Denotes a lead(Pb)-free/RoHS-compliant package.

T = Tape and reel, offered in 2.5k increments.

Package Information

For the latest package outline information and land patterns (footprints), go to www.maximintegrated.com/packages. Note that a "+", "#", or "-" in the package code indicates RoHS status only. Package drawings may show a different suffix character, but the drawing pertains to the package regardless of RoHS status.

PACKAGE TYPE	PACKAGE CODE	OUTLINE NO.	LAND PATTERN NO.
6 SOT23	U6+1	21-0058	90-0175

Chip Information

PROCESS: BiCMOS

Revision History

REVISION NUMBER	REVISION DATE	DESCRIPTION	PAGES CHANGED
0	5/08	Initial release	—
1	10/08	Update <i>Adjustable Delay (CDELAY)</i> and <i>Power-Supply Bypassing</i> sections.	9, 10
2	1/10	Revised the <i>Features</i> , <i>General Description</i> , <i>Absolute Maximum Ratings</i> , <i>Electrical Characteristics</i> , <i>Typical Operating Characteristics</i> , <i>Pin Description</i> , and the <i>Supply Input (VCC)</i> sections.	1, 2, 3, 5–8
3	4/14	No <i>I</i> V OPNs; removed Automotive reference from <i>Applications</i> section	1
4	5/15	Added the <i>Benefits and Features</i> section	1
5	3/16	Updated package outline drawing number in <i>Ordering Information</i> table	12

For pricing, delivery, and ordering information, please contact Maxim Direct at 1-888-629-4642, or visit Maxim Integrated's website at www.maximintegrated.com.

Maxim Integrated cannot assume responsibility for use of any circuitry other than circuitry entirely embodied in a Maxim Integrated product. No circuit patent licenses are implied. Maxim Integrated reserves the right to change the circuitry and specifications without notice at any time. The parametric values (min and max limits) shown in the *Electrical Characteristics* table are guaranteed. Other parametric values quoted in this data sheet are provided for guidance.