

## 6 Bit Digital Step Attenuator

1 MHz to 4000 MHz

### GENERAL DESCRIPTION

This document describes the specification for the IDT F1912 Digital Step Attenuator. The F1912 is part of a family of *Glitch-Free™* DSAs optimized for the demanding requirements of Base Station (BTS) radio cards and numerous other non-BTS applications. These devices are offered in a compact 4mm x 4mm 20 pin QFN package with 50Ω impedances for ease of integration.

### COMPETITIVE ADVANTAGE

Digital step attenuators are used in Receivers and Transmitters to provide gain control. The F1912 is a 6-bit step attenuator optimized for these demanding applications. The silicon design has very low insertion loss and low distortion (> +60 dBm IIP3.) The device has pinpoint accuracy. Most importantly, the F1912 includes IDT's *Glitch-Free™* technology which results in low overshoot & ringing during MSB transitions.

- ✓ *Glitch-Free™* Technology so PA or ADC will not be damaged during when transitions.
- ✓ Extremely accurate with low distortion.
- ✓ Lowest insertion loss for best SNR

### APPLICATIONS

- Base Station 2G, 3G, 4G, TDD radio cards
- Repeaters and E911 systems
- Digital Pre-Distortion
- Point to Point Infrastructure
- Public Safety Infrastructure
- WIMAX Receivers and Transmitters
- Military Systems, JTRS radios
- RFID handheld and portable readers
- Cable Infrastructure

### ORDERING INFORMATION



### FEATURES

- Serial & 6 bit Parallel Interface
- 31.5 dB Control Range
- 0.5 dB step
- *Glitch-Free™*, low transient overshoot
- 3.0 V to 5.25 V supply
- 1.8 V or 3.3 V control logic
- Attenuation Error < 0.22 dB @ 2 GHz
- Low Insertion Loss < 1.6 dB @ 2 GHz
- Ultra linear IIP3 > +59.5 dBm
- IIP2 = +110 dBm typical
- Stable Integral Non-Linearity over temperature
- Low Current Consumption 550 μA typical
- -40 °C to +105 °C operating temperature
- 4mm x 4mm Thin QFN 20 pin package

### FUNCTIONAL BLOCK DIAGRAM

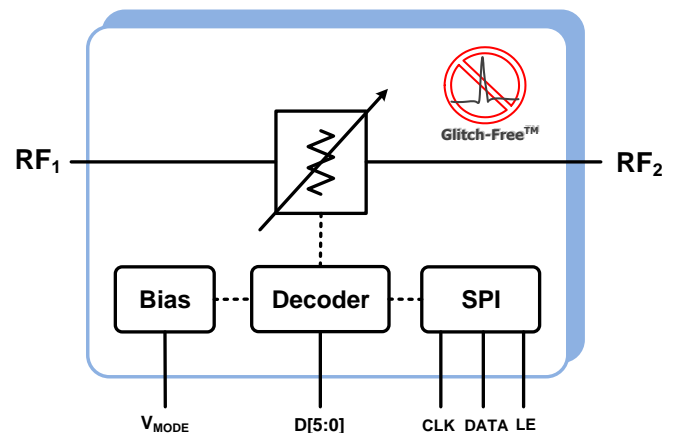

### Part# Details

Part#	Freq Range (MHz)	Resolution / Range (dB)	Control	IL (dB)	Pinout
F1950	150 - 4000	0.25 / 31.75	Parallel & Serial	1.3	PE43702 PE43701
F1951	100 - 4000	0.50 / 31.5	Serial Only	1.2	HMC305
F1952	100 - 4000	0.50 / 15.5	Serial Only	0.9	HMC305
F1953	400 - 4000	0.50 / 31.5	Parallel & Serial	1.3	PE4302 DAT-31R5
F1956	1 - 4000	0.25 / 31.75	Parallel & Serial	1.4	PE43705, RFSA3715
F1912	1 - 4000	0.50 / 31.5	Parallel & Serial	1.4	PE4312 PE4302

**6 Bit Digital Step Attenuator**
**1 MHz to 4000 MHz**
**ABSOLUTE MAXIMUM RATINGS**

Parameter	Symbol	Min	Max	Units
V <sub>DD</sub> to GND	V <sub>DD</sub>	-0.3	+5.5	V
DATA, LE, CLK, D[5:0]	V <sub>Logic</sub>	-0.3	Min (V <sub>DD</sub> -0.3, 3.6)	V
RF1, RF2	V <sub>RF</sub>	-0.3	+0.3	V
Maximum Input Power applied to RF1 or RF2 (>100 MHz)	P <sub>RF</sub>		+34	dBm
Operating Case Temperature			+105	°C
Maximum Junction Temperature	T <sub>Jmax</sub>		+140	°C
Junction Temperature	T <sub>jmax</sub>		140	°C
Continuous Power Dissipation			1.5	W
Storage Temperature Range	T <sub>st</sub>	-65	150	°C
Lead Temperature (soldering, 10s)			260	°C
Electrostatic Discharge – HBM (JEDEC/ESDA JS-001-2012)	V <sub>ESDHBM</sub>		2000 (Class 2)	Volts
ESD Voltage – CDM (Per JESD22-C101F)	V <sub>ESDCDM</sub>		500 (Class C2)	Volts

*Stresses above those listed above may cause permanent damage to the device. Functional operation of the device at these or any other conditions above those indicated in the operational section of this specification is not implied. Exposure to absolute maximum rating conditions for extended periods may affect device reliability.*

**ESD CAUTION**

*This product features proprietary protection circuitry. However, it may be damaged if subjected to high energy ESD. Please use proper ESD precautions when handling to avoid damage or loss of performance.*

**PACKAGE THERMAL AND MOISTURE CHARACTERISTICS**

θ <sub>JA</sub> (Junction – Ambient)	50 °C/W
θ <sub>JC</sub> (Junction – Case) [The Case is defined as the exposed paddle]	3 °C/W
Moisture Sensitivity Rating (Per J-STD-020)	MSL1

**6 Bit Digital Step Attenuator**

**1 MHz to 4000 MHz**

**F1912 RECOMMENDED OPERATING CONDITIONS**

Parameter	Symbol	Conditions	Min	Typ	Max	Units
Supply Voltage(s)	$V_{DD}$		3		5.25	V
Frequency Range	$F_{RF}$		1		4000	MHz
Operating Temperature Range	$T_{CASE}$	Exposed Paddle	-40		105	°C
RF CW Input Power	PCW	RF1 or RF2			See Figure 1	dBm
Source Impedance	$Z_{Source}$	Single Ended		50		$\Omega$
Load Impedance	$Z_{Load}$	Single Ended		50		$\Omega$

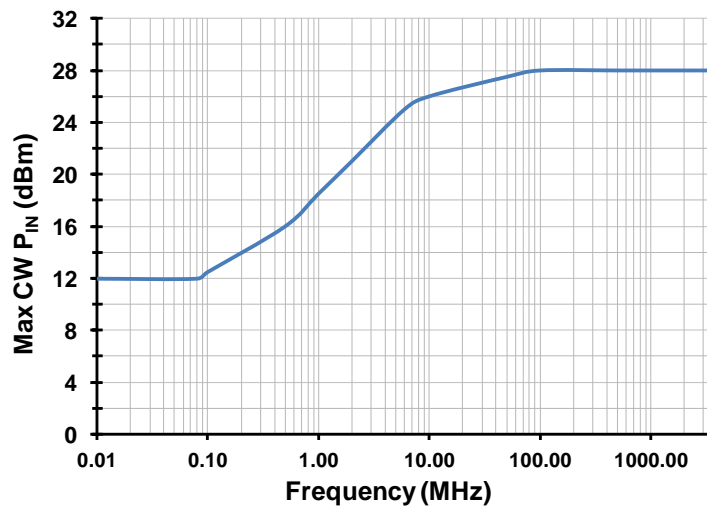

**Figure 1 Maximum Continuous Operating RF input power versus Input Frequency**

**6 Bit Digital Step Attenuator**
**1 MHz to 4000 MHz**
**F1912 SPECIFICATION**

Specifications apply at  $V_{DD} = +3.3\text{ V}$ ,  $T_{CASE} = +25\text{ }^{\circ}\text{C}$ ,  $F_{RF} = 2000\text{ MHz}$ ,  $P_{in} = 0\text{ dBm}$ , Serial Mode ( $V_{mode} > V_{IH}$ ),  $Z_{source} = Z_{Load} = 50\text{ }\Omega$  unless otherwise noted. EvKit losses are de-embedded.

Parameter	Symbol	Conditions	Min	Typ	Max	Units	
Logic Input High	$V_{IH}$	All Control Pins					
		$V_{DD} > 3.9\text{ V}$	<b>1.17</b>		<b>3.6</b>	V	
		$3.0 \leq V_{DD} \leq 3.9\text{ V}$	<b>1.17</b>		$V_{DD}-0.3$	V	
Logic Input Low	$V_{IL}$	All Control Pins			<b>0.63</b>	V	
Logic Current	$I_{IH}, I_{IL}$	All Control Pins	<b>-35</b>		<b>+35</b>	$\mu\text{A}$	
Supply Current	$I_{DD}$	$V_{DD} = 3.3\text{ V}$		550	<b>830<sup>1</sup></b>	$\mu\text{A}$	
		$V_{DD} = 5.0\text{ V}$		620	<b>900</b>		
RF1 Return Loss	$S_{11}$			18		dB	
RF2 Return Loss	$S_{22}$			18		dB	
Attenuation Step	LSB	Least Significant Bit		0.5		dB	
Insertion Loss (Minimum Attenuation)	$A_{MIN}$	D[5:0]=[000000] (IL State)		1.4	<b>2.0</b>	dB	
Insertion Loss (Maximum Attenuation)	$A_{MAX}$	D[5:0]=[111111]=31.5 dB	$32^2$	33.0		dB	
Step Error	DNL			0.10		dB	
Absolute Error	INL	D[5:0]=[100111]= 19.5 dB	<b>-0.7</b>		<b>+0.5</b>	dB	
Insertion Phase Delta	$\Phi_{\Delta}$	At 2 GHz		27		degrees	
		At 4 GHz		55			
Input IP3	IIP3	PIN = +10 dBm/tone, Tone Spacing = 50 MHz				dBm	
		Attn = 0.0 dB, $RF_{in} = RF1$	60	64.0			
		Attn = 0.0 dB, $RF_{in} = RF2$	56	60.5			
		Attn = 15.5 dB, $RF_{in} = RF1$	56	61.0			
			Attn = 15.5 dB, $RF_{in} = RF2$	57	61.5		
			Attn = 0.00 dB, $RF_{in} = RF1$ PIN = +22 dBm per tone 1 MHz Tone Separation				
			$F_{RF} = 0.7\text{ GHz}$	60	62.5		
			$F_{RF} = 1.8\text{ GHz}$	58	61.5		
		$F_{RF} = 2.2\text{ GHz}$	58	61.0			
		$F_{RF} = 2.6\text{ GHz}$	57	60.5			
Input IP2	IIP2	PIN = +12dBm/tone, $V_{DD}=5.0\text{V}$ F1=945 MHz, F2= 949 MHz F1+F2 = 1894 MHz $RF_{IN}= RF1$		110		dBm	
0.1dB Compression <sup>3</sup>	$P_{0.1}$	D[5:0] = [000000] = 0 dB		31		dBm	

Note 1: Items in min/max columns in **bold italics** are Guaranteed by Test.

Note 2: Items in min/max columns that are not bold/italics are Guaranteed by Design Characterization.

Note 3: The input 0.1dB compression point is a linearity figure of merit. Refer to Absolute Maximum Ratings section for the maximum RF input power.

Note 4: Spurious due to on-chip negative voltage generator. Typical generator fundamental frequency is 2.2 MHz.

Note 5: Speeds are measured after SPI programming is completed (data latched with LE = HIGH).

**6 Bit Digital Step Attenuator**
**1 MHz to 4000 MHz**
**F1912 SPECIFICATION (CONTINUED)**

Specifications apply at  $V_{DD} = +3.3\text{ V}$ ,  $T_{CASE} = +25\text{ }^{\circ}\text{C}$ ,  $F_{RF} = 2000\text{ MHz}$ ,  $P_{in} = 0\text{ dBm}$ , Serial Mode ( $V_{mode} > V_{IH}$ ),  $Z_{source} = Z_{Load} = 50\text{ }\Omega$  unless otherwise noted. EvKit losses are de-embedded.

Parameter	Symbol	Conditions	Min	Typ	Max	Units
MSB Step Time	$T_{LSB}$	Start LE rising edge $> V_{IH}$ End $\pm 0.10\text{ dB}$ Pout settling for 15.5 dB to 16.0 dB transition		500		ns
Maximum spurious level on any RF port <sup>4</sup>	$Spur_{MAX}$			-140		dBm
Maximum Switching Frequency	$SW_{FREQ}$			25		kHz
DSA Settling time	$\tau_{SET}$	Max to Min Attenuation to settle to within 0.5 dB of final value		0.9		$\mu\text{S}$
		Min to Max Attenuation to settle to within 0.5 dB of final value		1.8		
Control Interface	$SPI_{BIT}$			6		bit
Serial Clock Speed	$SPI_{CLK}$				<b>25</b>	MHz

Note 1: Items in min/max columns in ***bold italics*** are Guaranteed by Test.

Note 2: Items in min/max columns that are not bold/italics are Guaranteed by Design Characterization.

Note 3: The input 0.1dB compression point is a linearity figure of merit. Refer to Absolute Maximum Ratings section for the maximum RF input power.

Note 4: Spurious due to on-chip negative voltage generator. Typical generator fundamental frequency is 2.2 MHz.

Note 5: Speeds are measured after SPI programming is completed (data latched with LE = HIGH).

**6 Bit Digital Step Attenuator**
**1 MHz to 4000 MHz**
**PROGRAMMING OPTIONS**

F1912 can be programmed using either the parallel or serial interface which is selectable via  $V_{MODE}$  (pin 13). Serial mode is selected by floating  $V_{MODE}$  or pulling it to a voltage logic high (greater than  $V_{IH}$ ) and parallel mode is selected by setting  $V_{MODE}$  to logic low (less than  $V_{IL}$ ).

**SERIAL CONTROL MODE**

F1912 Serial mode is selected by floating  $V_{MODE}$  (pin 13) or pulling it to a voltage  $> V_{IH}$ . The serial interface is a 6 bit shift register to shift in the data MSB (D5) first. When serial programming is used, all the parallel control input pins (1, 15, 16, 17, 19, 20) **must** be grounded.

**Table 1 - 6 Bit SPI Word Sequence**

D5	Attenuation 16 dB Control Bit
D4	Attenuator 8 dB Control Bit
D3	Attenuator 4 dB Control Bit
D2	Attenuator 2 dB Control Bit
D1	Attenuator 1 dB Control Bit
D0	Attenuator 0.5 dB Control Bit

**Table 2 - Truth Table for Serial Control Word**

D5 (MSB)	D4	D3	D2	D1	D0 (LSB)	Attenuation (dB)
0	0	0	0	0	0	0
0	0	0	0	0	1	0.5
0	0	0	0	1	0	1
0	0	0	1	0	0	2
0	0	1	0	0	0	4
0	1	0	0	0	0	8
1	0	0	0	0	0	16
1	1	1	1	1	1	31.5

**Serial Mode REGISTER TIMING DIAGRAM: (Note the Timing Spec Intervals in Blue)**

With serial control, the F1912 can be programmed via the serial port on the rising edge of Latch Enable (LE) which loads the last 6 DATA line bits [formatted MSB (D5) first] resident in the SHIFT register followed by the next 5 bits.

**6 Bit Digital Step Attenuator**

**1 MHz to 4000 MHz**

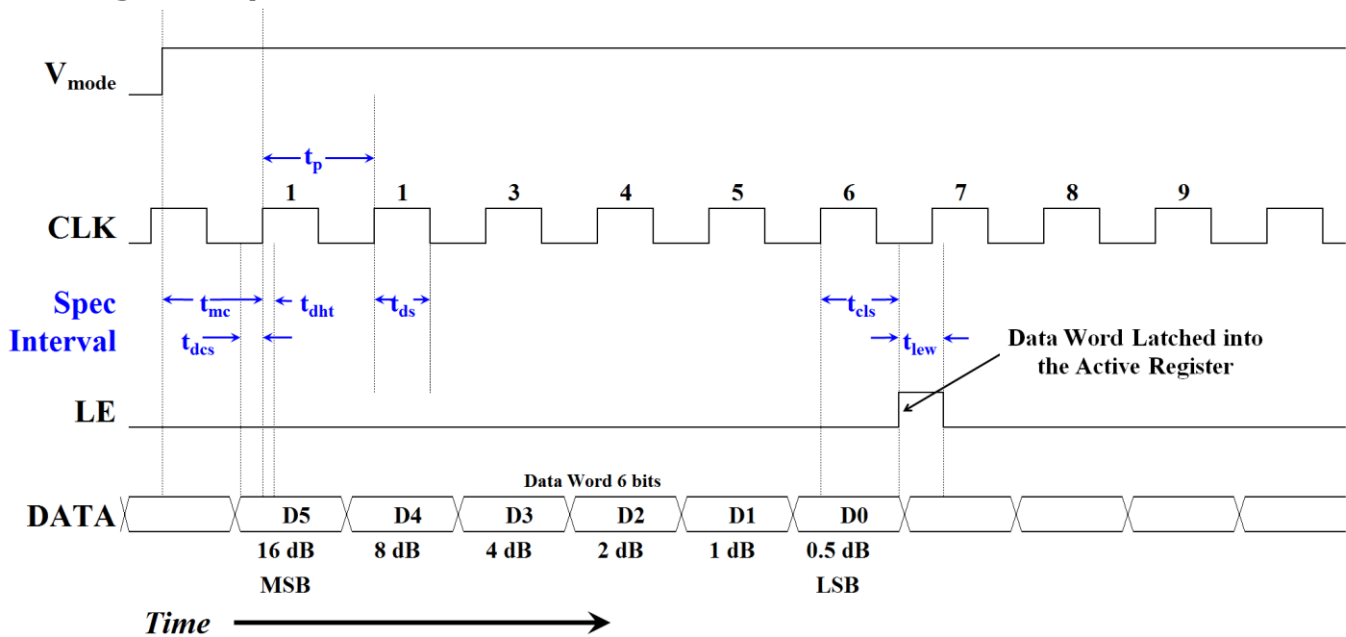

**Figure 2 - Serial Register Timing Diagram**

**Note** - When Latch enable is high, the shift register is disabled and DATA is NOT continuously clocked into the shift register which minimizes noise. It is recommended that Latch enable be left high when the device is not being programmed.

**Table 3 - Serial Mode Timing Table**

Interval Symbol	Description	Min Spec	Max Spec	Units
$t_{mc}$	Parallel to Serial Setup Time - From rising edge of $V_{MODE}$ to rising edge of CLK for D5	<b>100</b>		ns
$t_{ds}$	Clock high pulse width	<b>10</b>		ns
$t_{cls}$	LE Setup Time - From the rising edge of CLK pulse for D0 to LE rising edge minus half the clock period.	<b>10</b>		ns
$t_{lew}$	LE pulse width	<b>30</b>		ns
$t_{dsc}$	Data Setup Time - From the starting edge of Data bit to rising edge of CLK	<b>10</b>		ns
$T_{dht}$	Data Hold Time - From rising edge of CLK to falling edge of the Data bit.	<b>10</b>		ns

**6 Bit Digital Step Attenuator**
**1 MHz to 4000 MHz**
**Serial Mode Default Startup Condition:**

When the device is first powered up it will default to the Maximum Attenuation of 31.5 dB independent of the  $V_{MODE}$  and parallel pin [D5:D0] conditions.

**Table 4 - Default Control Word for the Serial Mode**

D5 (MSB)	D4	D3	D2	D1	D0 (LSB)	Attenuation (dB)
1	1	1	1	1	1	31.5

**PARALLEL CONTROL MODE**

For the F1912 the user has the option of running in one of two parallel modes. Direct Parallel Mode or Latched Parallel Mode.

**Direct Parallel Mode:**

Direct Parallel Mode is selected when  $V_{MODE}$  (pin 13) is less than  $V_{IL}$  and LE (pin 5) is greater than  $V_{IH}$ . In this mode the device will immediately react to any voltage changes to the parallel control pins [pins 1, 15, 16, 17, 19, 20]. Use direct parallel mode for the fastest settling time.

**Latched Parallel Mode:**

Latched Parallel Mode is selected when  $V_{MODE}$  is less than  $V_{IL}$  and LE (pin 5) is toggled from less than  $V_{IL}$  to greater than  $V_{IH}$ . To utilize Latched Parallel Mode:

- Set  $LE < V_{IL}$
- Adjust pins [pins 1, 15, 16, 17, 19, 20] to the desired attenuation setting. (Note the device will not react to these pins while  $LE < V_{IL}$ .)
- Pull  $LE > V_{IH}$ . The device will then transition to the attenuation settings reflected by pins D5 – D0.

Latched Parallel Mode implies a default state for when the device is first powered up with  $V_{MODE} < V_{IL}$  and  $LE < V_{IL}$ . In this case the default setting is MAXIMUM Attenuation.

**Table 5 - Truth Table for the Parallel Control Word**

D5	D4	D3	D2	D1	D0	Attenuation (dB)
0	0	0	0	0	0	0
0	0	0	0	0	1	0.5
0	0	0	0	1	0	1
0	0	0	1	0	0	2
0	0	1	0	0	0	4
0	1	0	0	0	0	8
1	0	0	0	0	0	16
1	1	1	1	1	1	31.5



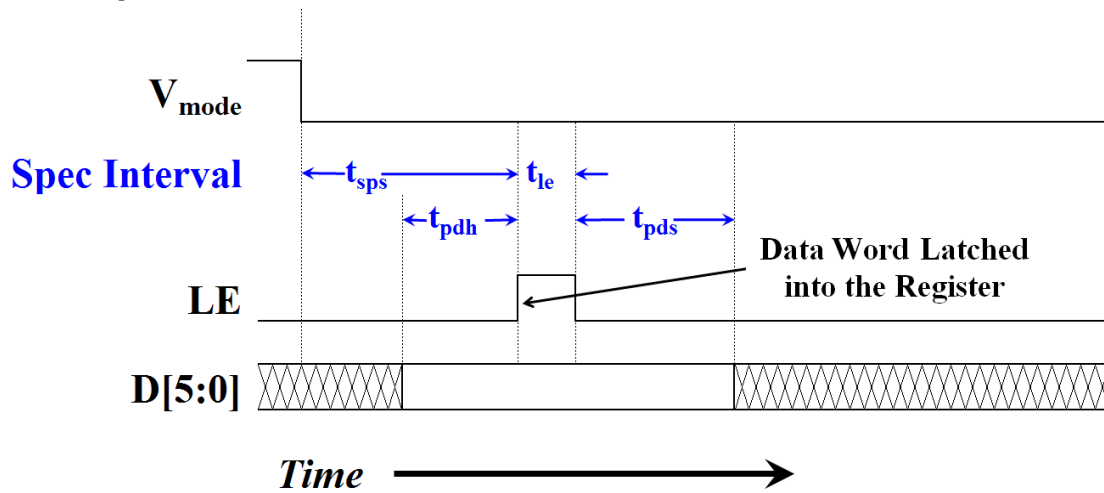

**Figure 3 - Latched Parallel Mode Timing Diagram**

**Table 6 - Latched Parallel Mode Timing**

<b>Interval Symbol</b>	<b>Description</b>	<b>Min Spec</b>	<b>Max Spec</b>	<b>Units</b>
$t_{sps}$	Serial to Parallel Mode Setup Time	100		ns
$t_{pdh}$	Parallel Data Hold Time	10		ns
$t_{pds}$	LE minimum pulse width	10		ns
$t_{ie}$	Parallel Data Setup Time	10		ns



**6 Bit Digital Step Attenuator**

**1 MHz to 4000 MHz**

**TYPICAL OPERATING CONDITIONS (TOC)**

Unless otherwise noted for the TOC graphs on the following pages, the following conditions apply.

- **V<sub>DD</sub> = +3.30 V**
- **T<sub>CASE</sub> = +25 °C**
- **F<sub>RF</sub> = 2 GHz**
- **P<sub>IN</sub> = 0 dBm for single tone measurements**
- **P<sub>IN</sub> = +10 dBm/tone for multi-tone measurements**
- **Tone Spacing = 50 MHz**
- **EVKit connector and board losses are de-embedded**



**6 Bit Digital Step Attenuator**

**1 MHz to 4000 MHz**

**TYPICAL OPERATING CONDITIONS (- 1 -)**

**Insertion Loss vs Frequency**

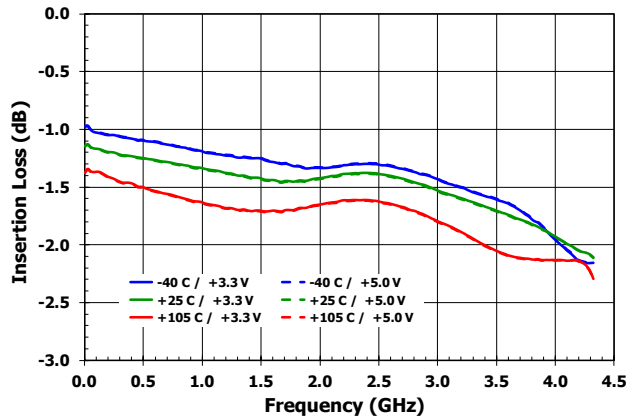

**Insertion Loss vs Attenuation State**

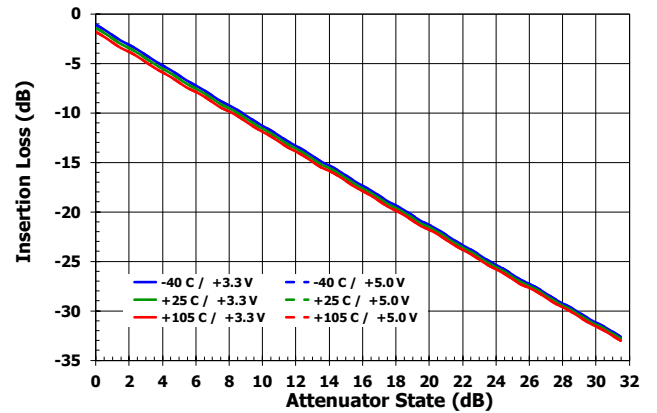

**RF1 (Input) Return Loss vs Frequency [All States]**

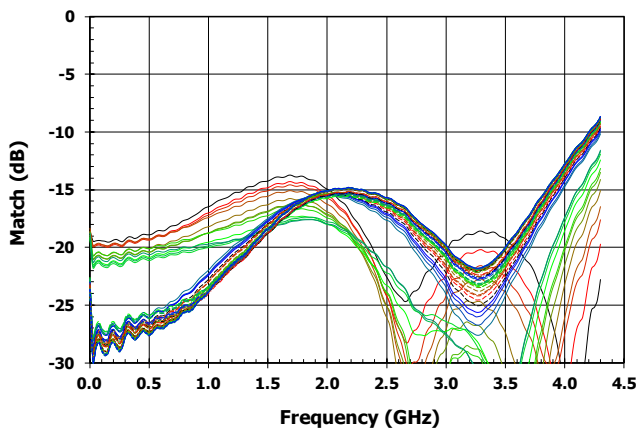

**RF1 (Input) Return Loss vs Attenuation State**

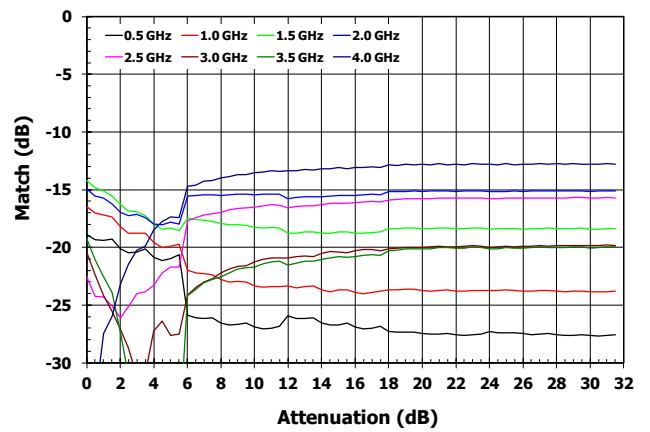

**RF2 (Output) Return Loss vs Frequency [All States]**

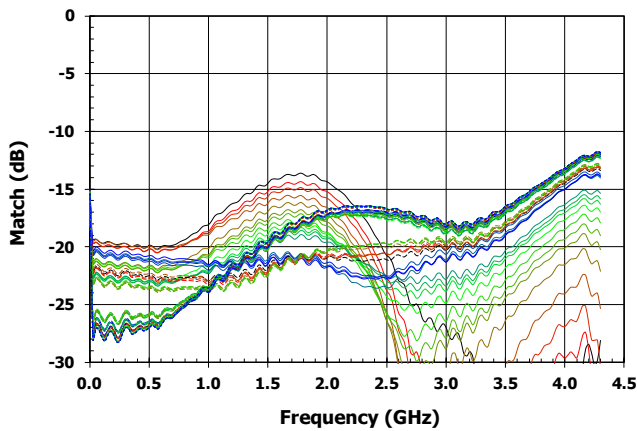

**RF2 (Output) Return Loss vs Attenuation State**

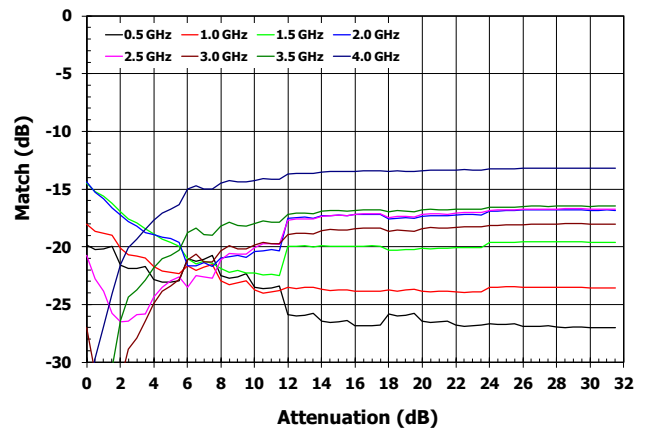



**6 Bit Digital Step Attenuator**

**1 MHz to 4000 MHz**

**TYPICAL OPERATING CONDITIONS (- 2 -)**

**Relative Insertion Phase vs Frequency**

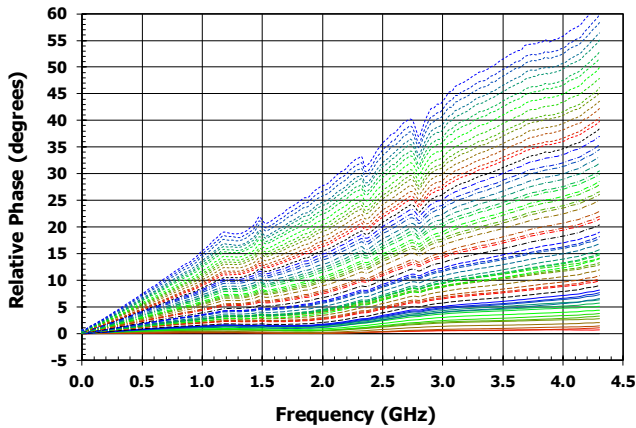

**Relative Insertion Phase vs Attenuation**

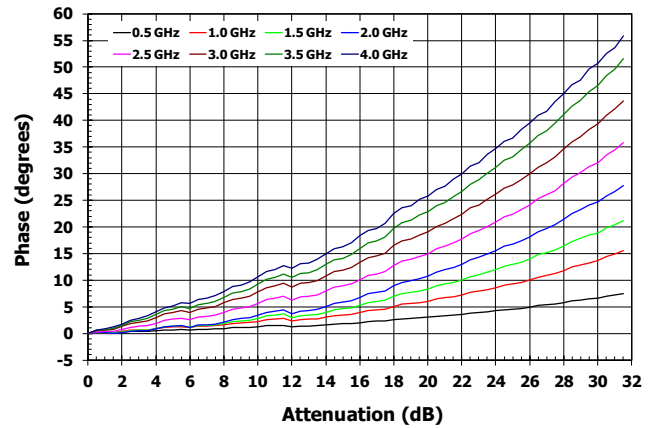

**Worst Case Absolute Accuracy vs Frequency**

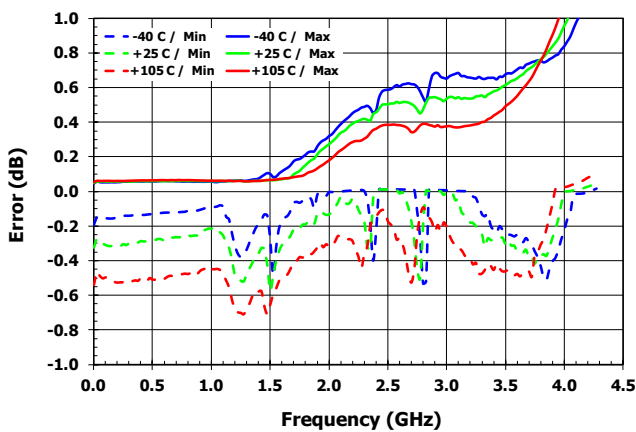

**Absolute Accuracy vs Attenuation**

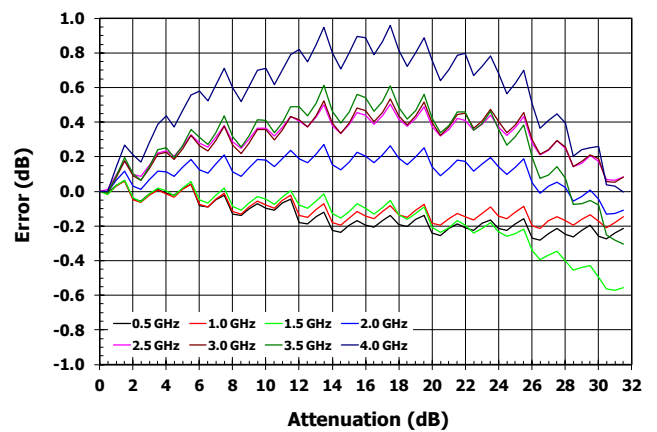

**Worst Case Step Accuracy vs Frequency**

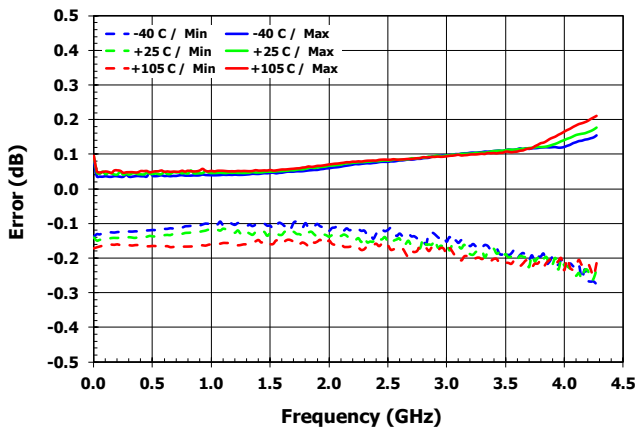

**Step Accuracy vs Attenuation**

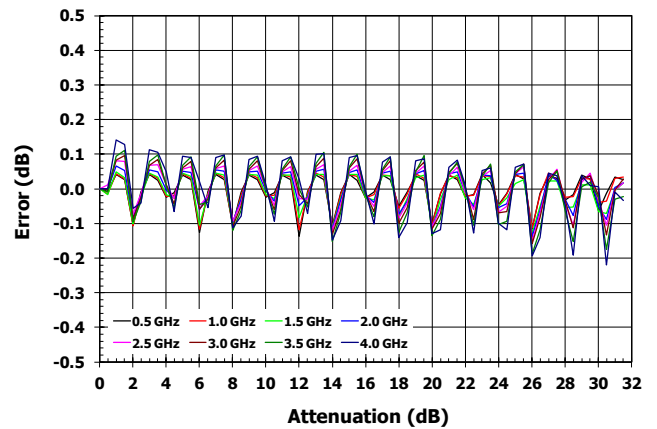



**6 Bit Digital Step Attenuator**

**1 MHz to 4000 MHz**

**TYPICAL OPERATING CONDITIONS (- 3 -)**

**Compression at 0 dB and 2 GHz**

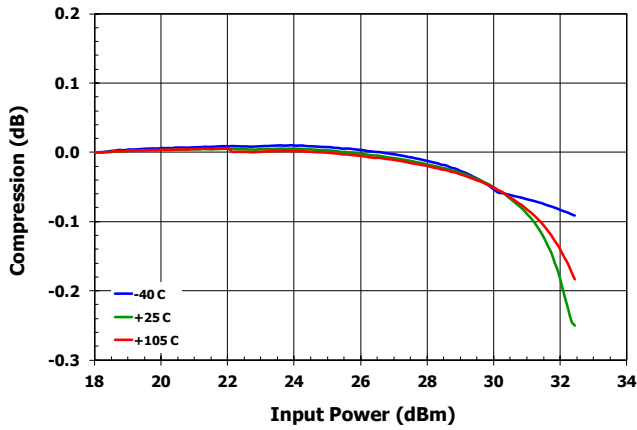

**Input IP3 - 0 dB, +22 dBm, 1 MHz Tone Delta, RF1**

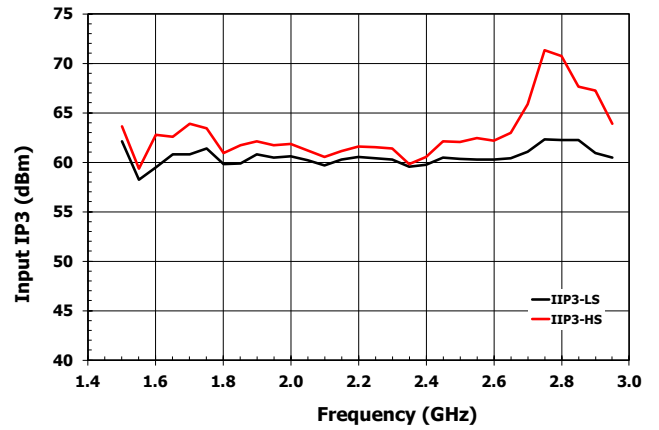

**Compression at 15.5 dB and 2 GHz**

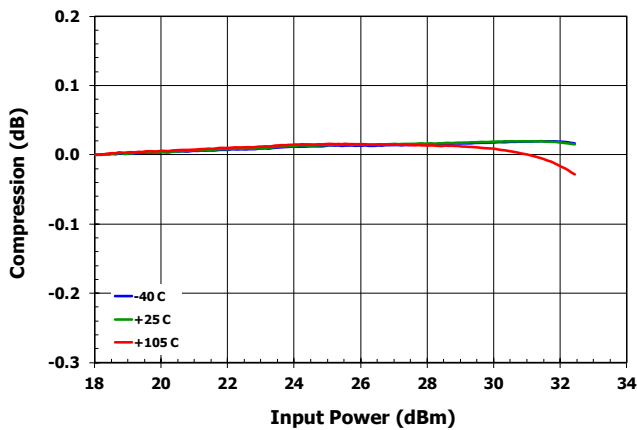

**Input IP3 (Low Side) vs attenuation at 2GHz**

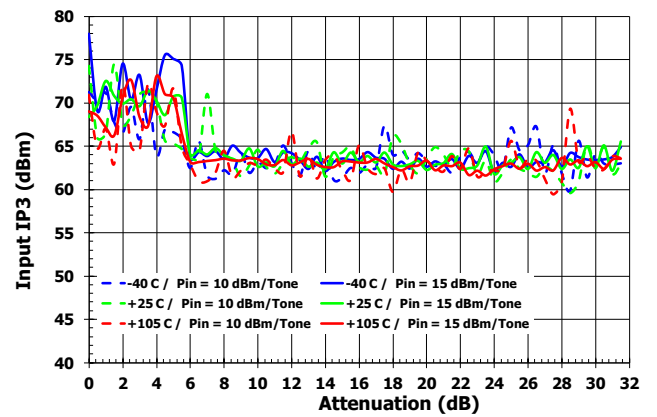

**Compression at 31.5 dB and 2 GHz**

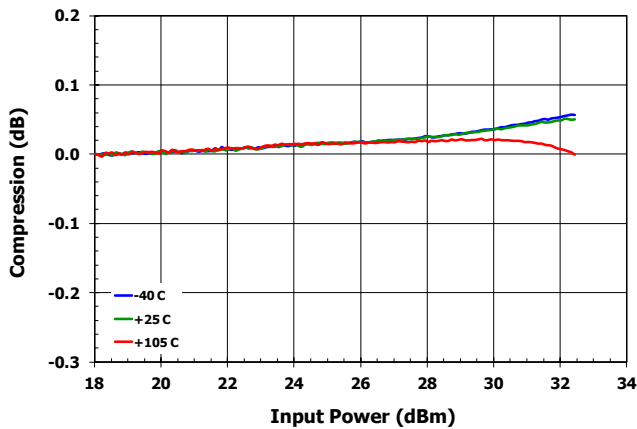

**Input IP3 (High Side) vs attenuation at 2GHz**

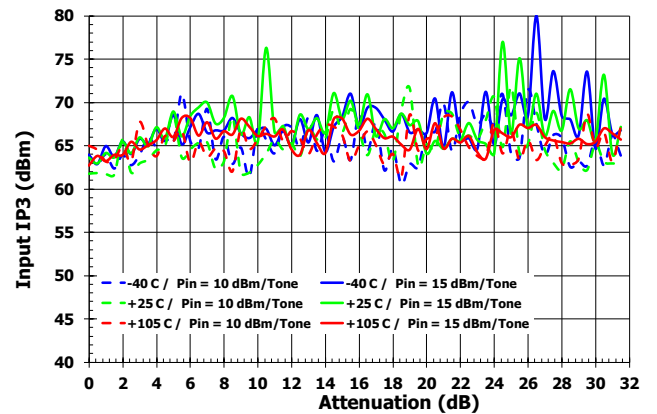

## 6 Bit Digital Step Attenuator

1 MHz to 4000 MHz

### PACKAGE DRAWING

(4 mm x 4 mm 20-pin TQFN), **NCG20**

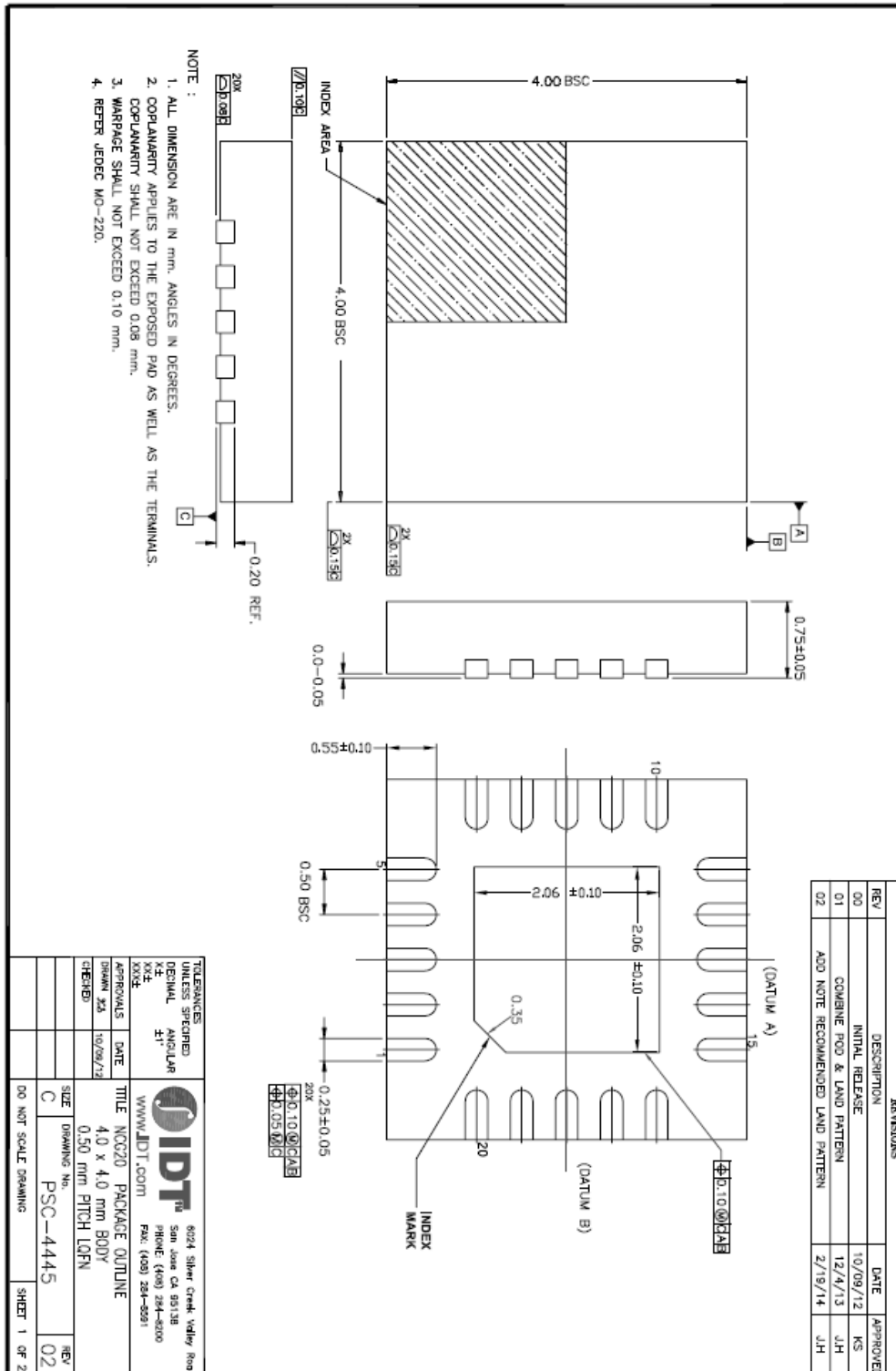



**6 Bit Digital Step Attenuator**

**1 MHz to 4000 MHz**

**LAND PATTERN DIMENSION**

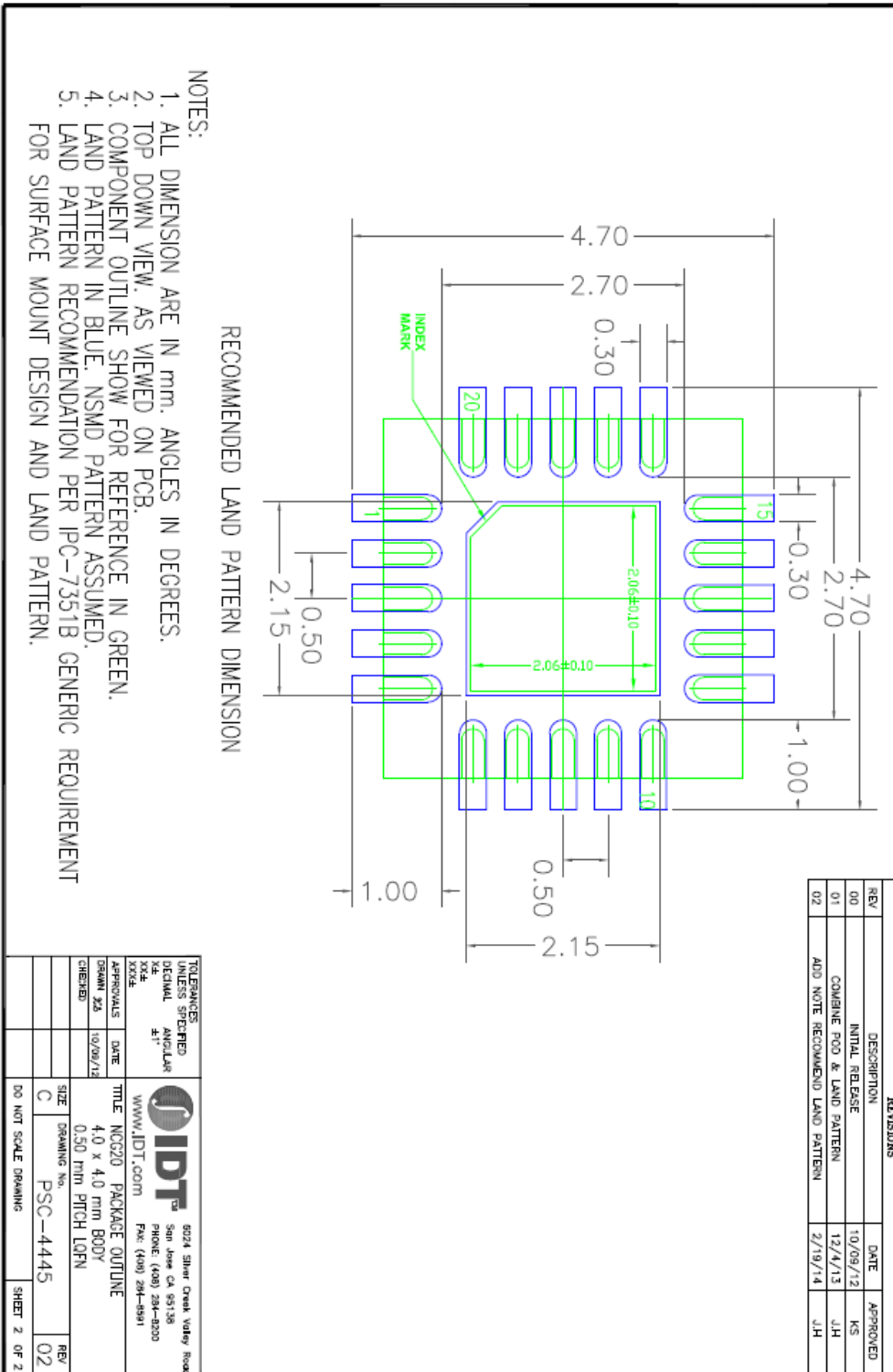

**6 Bit Digital Step Attenuator**  
**PIN DIAGRAM**

**1 MHz to 4000 MHz**

**TOP View**  
*(looking through the top of the package)*

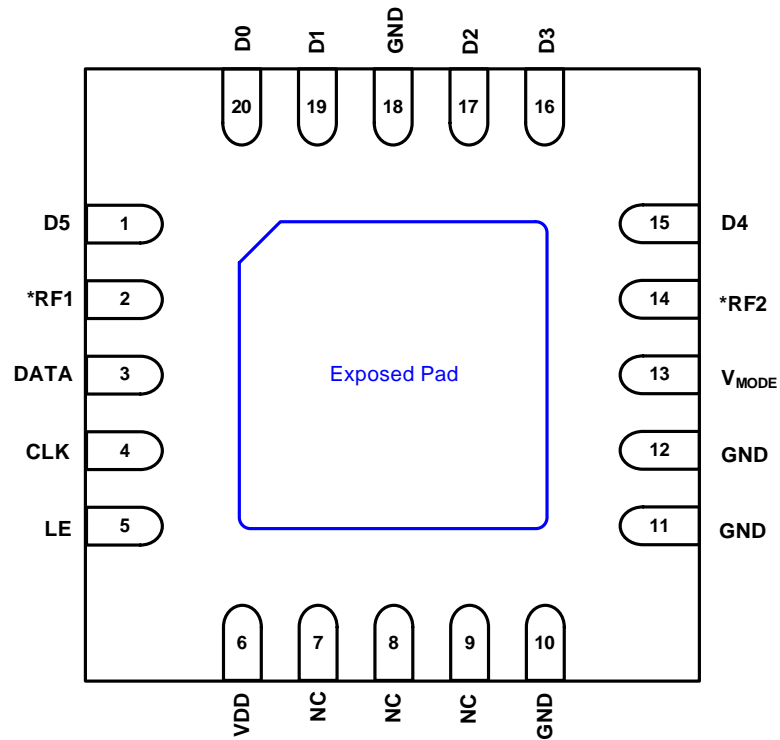

*\* Device is RF Bi-Directional*





**6 Bit Digital Step Attenuator**

**1 MHz to 4000 MHz**

**PIN DESCRIPTION**

<b>PIN</b>	<b>NAME</b>	<b>FUNCTION</b>
1	D5	16 dB Attenuation Control Bit. Pull high for 16 dB ATTN.
2	RF1	Device RF input or output (bi-directional). Internally DC blocked.
3	DATA	Serial interface Data Input.
4	CLK	Serial interface Clock Input.
5	LE	Serial interface Latch Enable Input. Internal pullup (100K ohm).
6	VDD	Power supply pin.
7	NC	Internally unconnected.
8	NC	Internally unconnected.
9	NC	Internally unconnected.
10	GND	Connect to Ground. This pin is internally connected to the exposed paddle.
11	GND	Connect to Ground. This pin is internally connected to the exposed paddle.
12	GND	Connect to Ground. This pin is internally unconnected.
13	VMODE	Pull high for serial control mode. Ground for parallel control mode.
14	RF2	Device RF input or output (bi-directional). Internally DC blocked.
15	D4	8 dB Attenuation Control Bit. Pull high for 8 dB ATTN.
16	D3	4 dB Attenuation Control Bit. Pull high for 4 dB ATTN.
17	D2	2 dB Attenuation Control Bit. Pull high for 2 dB ATTN.
18	GND	Connect to Ground. This pin is internally unconnected.
19	D1	1 dB Attenuation Control Bit. Pull high for 1 dB ATTN.
20	D0	0.5 dB Attenuation Control Bit. Pull high for 0.5 dB ATTN.
EP	Exposed Paddle	Exposed Pad. Internally connected to GND. Solder this exposed pad to a PCB pad that uses multiple ground vias to provide heat transfer out of the device into the PCB ground planes. These multiple via grounds are also required to achieve the specified RF performance.

### 6 Bit Digital Step Attenuator

#### EVKIT PICTURE

1 MHz to 4000 MHz

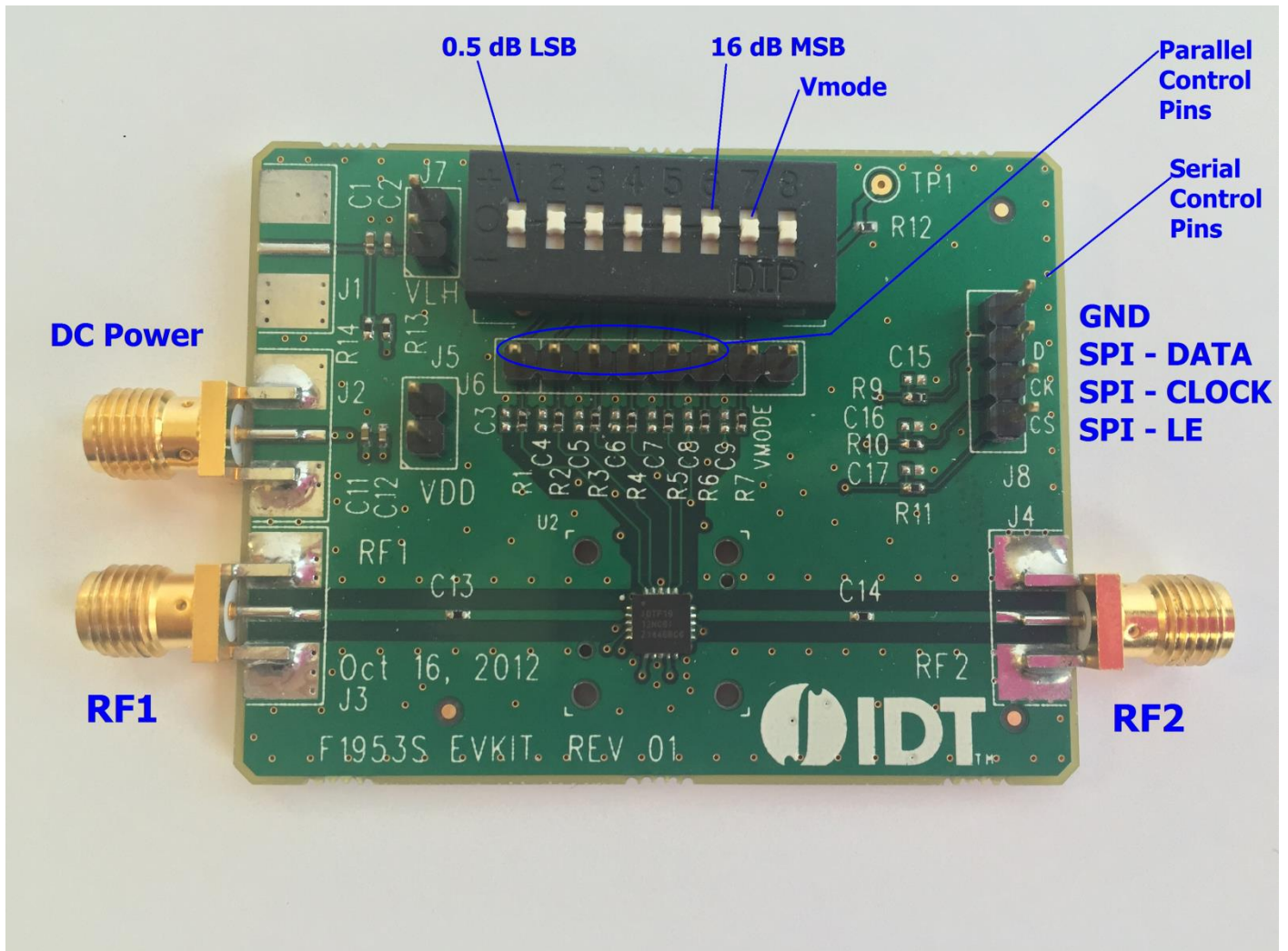

## 6 Bit Digital Step Attenuator EVKIT / APPLICATIONS CIRCUIT

1 MHz to 4000 MHz

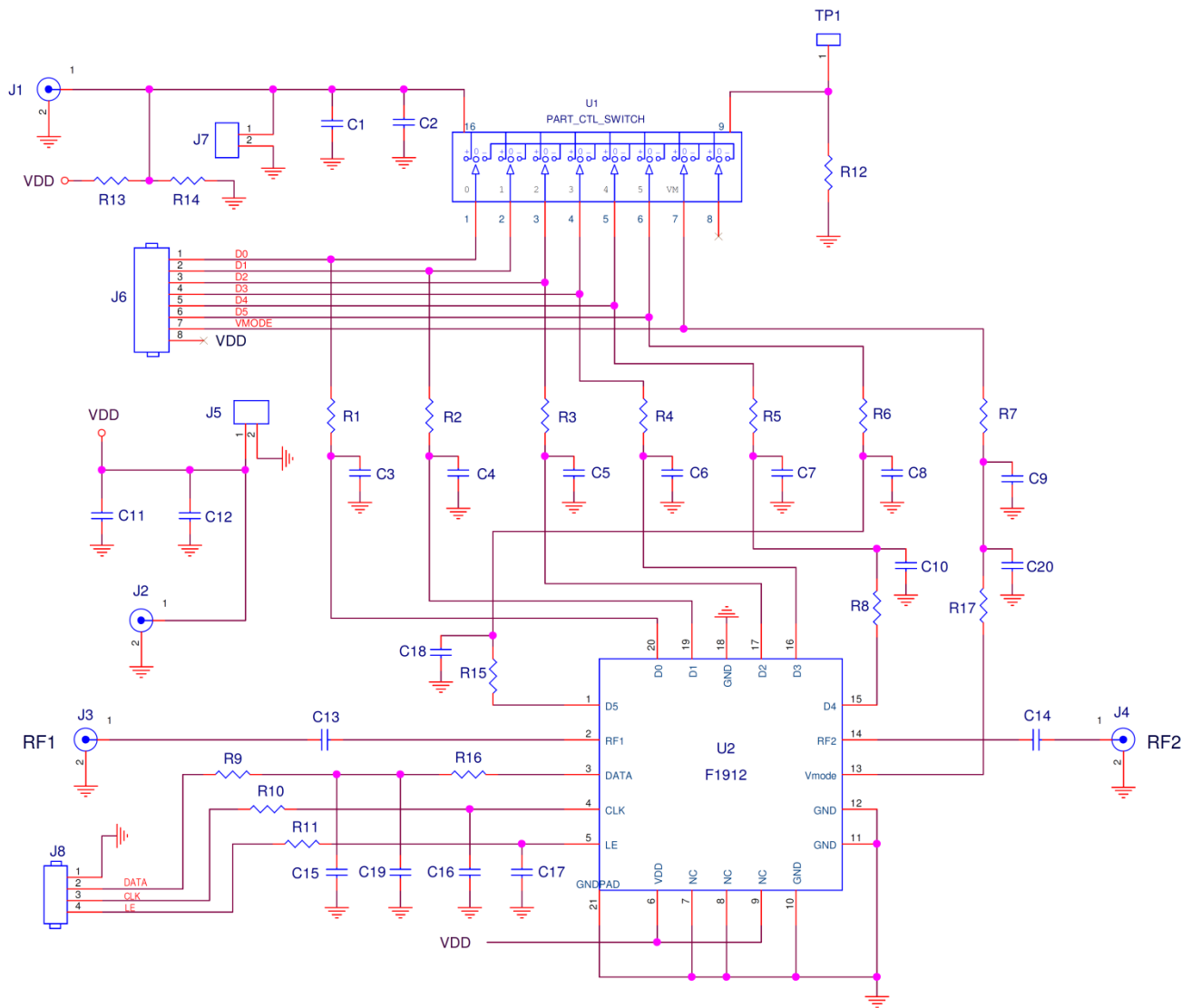

**6 Bit Digital Step Attenuator**  
**EVKIT BOM**

**1 MHz to 4000 MHz**

Item #	Part Reference	QTY	DESCRIPTION	Mfr. Part #	Mfr.
1	C1, C11	2	100nF ±10%, 50V, X7R Ceramic Capacitor (0402)	GRM155R71H104K	MURATA
2	C2, C12	2	10nF ±5%, 50V, COG Ceramic Capacitor (0402)	GRM155R71H103J	MURATA
3	R12, C13, C14	3	0Ω Resistors (0402)	ERJ-2GE0R00X	PANASONIC
4	R1-R7	7	100Ω ±1%, 1/10W, Resistor (0402)	ERJ-2RKF1000X	PANASONIC
5	R9, R10, R11	3	3kΩ ±1%, 1/10W, Resistor (0402)	ERJ-2RKF3001X	PANASONIC
6	R8, R15, R16, R17	4	10kΩ ±1%, 1/10W, Resistor (0402)	ERJ-2RKF1002X	PANASONIC
7	R13	1	100kΩ ±1%, 1/10W, Resistor (0402)	ERJ-2RKF1003X	PANASONIC
8	R14	1	267kΩ ±1%, 1/10W, Resistor (0402)	ERJ-2RKF2673X	PANASONIC
9	J5, J7	2	CONN HEADER VERT SGL 2 X 1 POS GOLD	961102-6404-AR	3M
10	J8	1	CONN HEADER VERT SGL 4 X 1 POS GOLD	961104-6404-AR	3M
11	J6	1	CONN HEADER VERT SGL 8 X 1 POS GOLD	961108-6404-AR	3M
12	J2, J3, J4	3	Edge Launch SMA (0.250 inch pitch ground, round)	142-0711-821	Emerson Johnson
13	U1	1	SWITCH 8 POSITION DIP SWITCH	KAT1108E	E-Switch
14	U2	1	DSA	F1912Z	IDT
15		1	Printed Circuit Board (Rev 01)	F1953S Eokit Rev 01	IDT
16			Bill Of Material (Rev 01)		

**TOP MARKINGS**

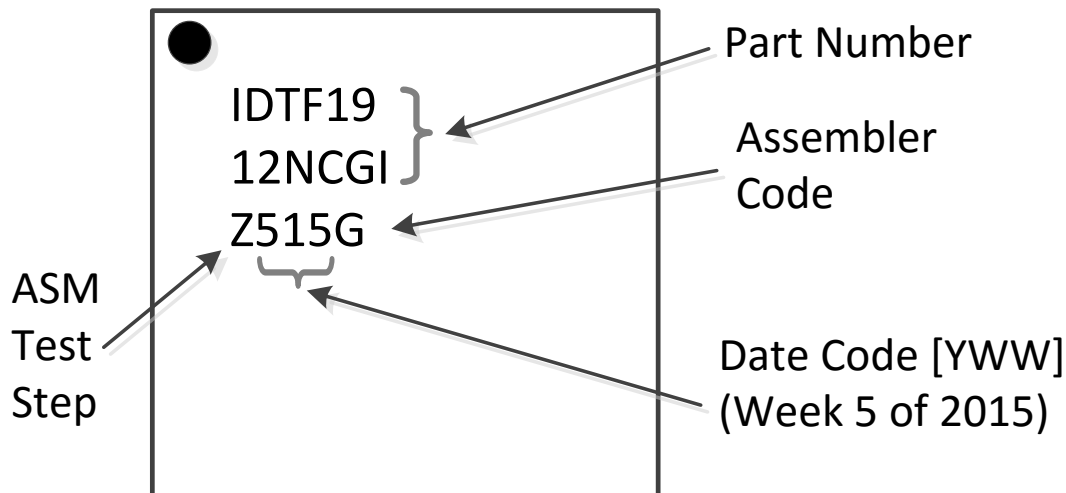

**6 Bit Digital Step Attenuator****1 MHz to 4000 MHz****APPLICATIONS INFORMATION****F1912 Digital Pin Voltage & Resistance Values (pins not connected)**

The following table lists the resistance between various pins and ground when no DC power is applied. When the device is powered up with +5 Volts DC these same pins to should have the measured voltage to ground.

<b>Pin</b>	<b>Name</b>	<b>DC voltage (volts)</b>	<b>Resistance (ohms)</b>
13	V <sub>MODE</sub>	2.5V	100 k $\Omega$ pullup resistor to internally regulated 2.5 V
3, 4, 5	DATA, CLK, LE	2.5V	100 k $\Omega$ pullup resistor to internally regulated 2.5 V



**6 Bit Digital Step Attenuator**

**1 MHz to 4000 MHz**

**Revision History**

Revision	Revision Date	Description of Change
1	2017-May-26	Corrected pin label on Page 16.
0	2015-June-06	Initial release of the datasheet



**Corporate Headquarters**  
6024 Silver Creek Valley Road  
San Jose, CA 95138  
[www.IDT.com](http://www.IDT.com)

**Sales**  
1-800-345-7015 or 408-284-8200  
Fax: 408-284-2775  
[www.IDT.com/go/sales](http://www.IDT.com/go/sales)

**Tech Support**  
[www.IDT.com/go/support](http://www.IDT.com/go/support)

DISCLAIMER Integrated Device Technology, Inc. (IDT) and its affiliated companies (herein referred to as "IDT") reserve the right to modify the products and/or specifications described herein at any time, without notice, at IDT's sole discretion. Performance specifications and operating parameters of the described products are determined in an independent state and are not guaranteed to perform the same way when installed in customer products. The information contained herein is provided without representation or warranty of any kind, whether express or implied, including, but not limited to, the suitability of IDT's products for any particular purpose, an implied warranty of merchantability, or non-infringement of the intellectual property rights of others. This document is presented only as a guide and does not convey any license under intellectual property rights of IDT or any third parties.

IDT's products are not intended for use in applications involving extreme environmental conditions or in life support systems or similar devices where the failure or malfunction of an IDT product can be reasonably expected to significantly affect the health or safety of users. Anyone using an IDT product in such a manner does so at their own risk, absent an express, written agreement by IDT.

Integrated Device Technology, IDT and the IDT logo are trademarks or registered trademarks of IDT and its subsidiaries in the United States and other countries. Other trademarks used herein are the property of IDT or their respective third party owners. For datasheet type definitions and a glossary of common terms, visit [www.idt.com/go/glossary](http://www.idt.com/go/glossary). All contents of this document are copyright of Integrated Device Technology, Inc. All rights reserved.