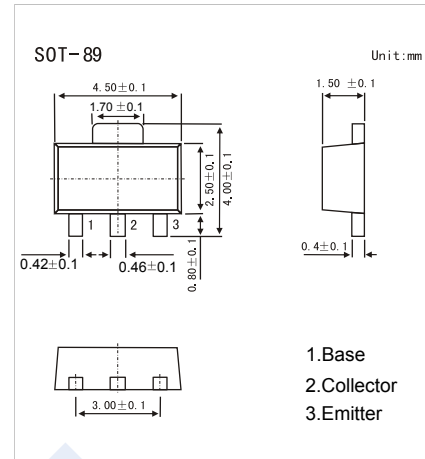

## NPN Transistors

## 2SC4942

## ■ Features

- High voltage
- Fast switching speed
- Complementary transistor with the 2SA1871

■ Absolute Maximum Ratings  $T_a = 25^\circ\text{C}$ 

Parameter	Symbol	Rating	Unit
Collector - Base Voltage	$V_{CB0}$	600	V
Collector - Emitter Voltage	$V_{CE0}$	600	
Emitter - Base Voltage	$V_{EB0}$	7	
Collector Current - Continuous	$I_C$	1	A
Collector current -pulse (Note.1)	$I_{CP}$	2	
Collector Power Dissipation	$P_C$	2	W
Junction Temperature	$T_J$	150	$^\circ\text{C}$
Storage Temperature Range	$T_{stg}$	-55 to 150	

Note.1 : Pulse :  $P_W \leq 10\text{ms}$ , Duty Cycle  $\leq 50\%$

■ Electrical Characteristics  $T_a = 25^\circ\text{C}$ 

Parameter	Symbol	Test Conditions	Min	Typ	Max	Unit
Collector- base breakdown voltage	$V_{CB0}$	$I_C = 100 \mu\text{A}$ , $I_E = 0$	600			V
Collector- emitter breakdown voltage	$V_{CE0}$	$I_C = 1 \text{mA}$ , $I_B = 0$	600			
Emitter - base breakdown voltage	$V_{EB0}$	$I_E = 100 \mu\text{A}$ , $I_C = 0$	7			
Collector-base cut-off current	$I_{CBO}$	$V_{CB} = 600\text{V}$ , $I_E = 0$			10	$\mu\text{A}$
Emitter cut-off current	$I_{EBO}$	$V_{EB} = 7\text{V}$ , $I_C = 0$			10	
Collector-emitter saturation voltage	$V_{CE(sat)}$	$I_C = 400 \text{mA}$ , $I_B = 80\text{mA}$		0.35	1	V
Base - emitter saturation voltage	$V_{BE(sat)}$	$I_C = 400 \text{mA}$ , $I_B = 80\text{mA}$		0.9	1.2	
DC current gain	$h_{FE}$	$V_{CE} = 5\text{V}$ , $I_C = 100\text{mA}$	30	55	120	
		$V_{CE} = 5\text{V}$ , $I_C = 500\text{mA}$	5	10		
Turn-on time	$t_{on}$	$I_C = 0.5 \text{A}$ , $V_{CC} = 250 \text{V}$ $I_{B1} = -I_{B2} = 0.1 \text{A}$ $R_L = 500 \Omega$		0.1	0.5	$\mu\text{s}$
Storage time	$t_{stg}$			4	5	
Turn-off time	$t_{off}$			0.2	0.5	
Collector output capacitance	$C_{ob}$	$V_{CB} = 10\text{V}$ , $I_E = 0$ , $f = 1\text{MHz}$		15		pF
Transition frequency	$f_T$	$V_{CE} = 5\text{V}$ , $I_E = -50\text{mA}$		30		MHz

■ Classification of  $h_{FE}(1)$ 

Type	2SC4942-A1	2SC4942-A2	2SC4942-A3
Range	30-60	40-80	60-120
Marking	AA1	AA2	AA3

# NPN Transistors

## 2SC4942

### Typical Characteristics

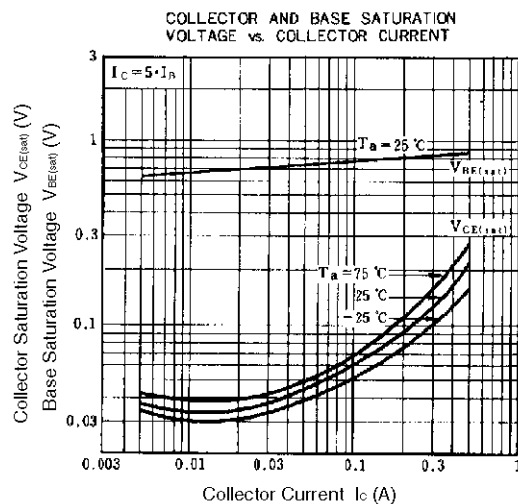
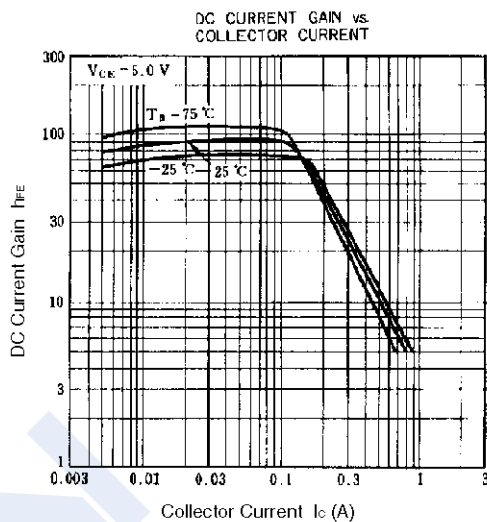
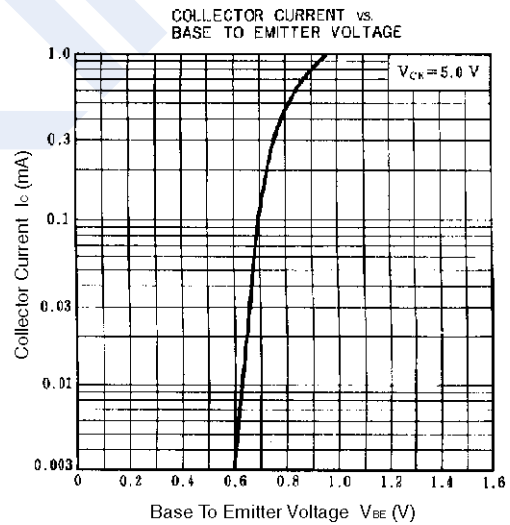
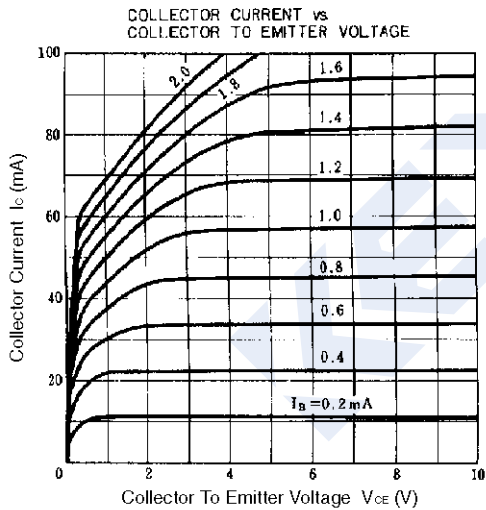
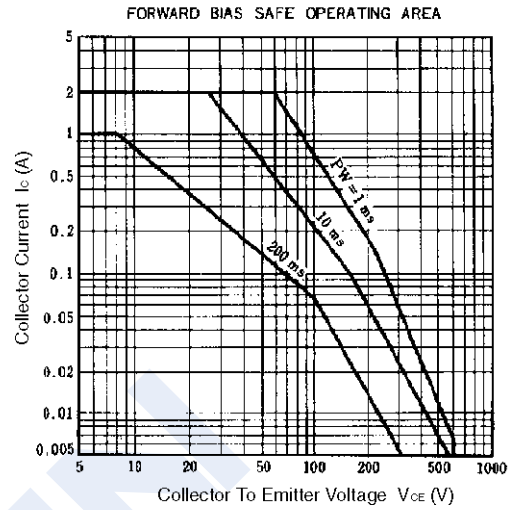
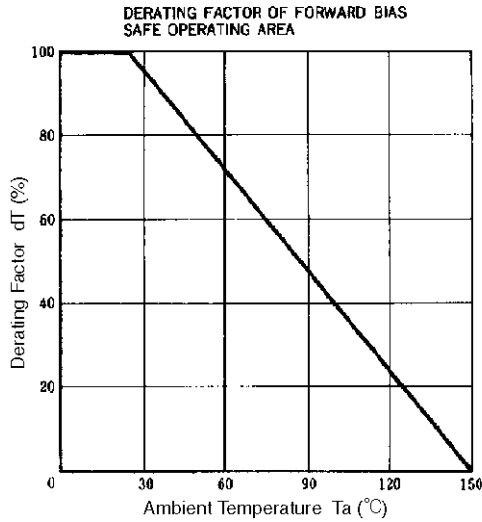

## NPN Transistors

## 2SC4942

## ■ Typical Characteristics

