

Silicon NPN Power Transistors

2SC3591

DESCRIPTION

- With TO-220C package
- Fast switching speed
- Low collector saturation voltage

APPLICATIONS

- High-definition CRT display horizontal deflection output applications

PINNING

PIN	DESCRIPTION
1	Base
2	Collector;connected to mounting base
3	Emitter

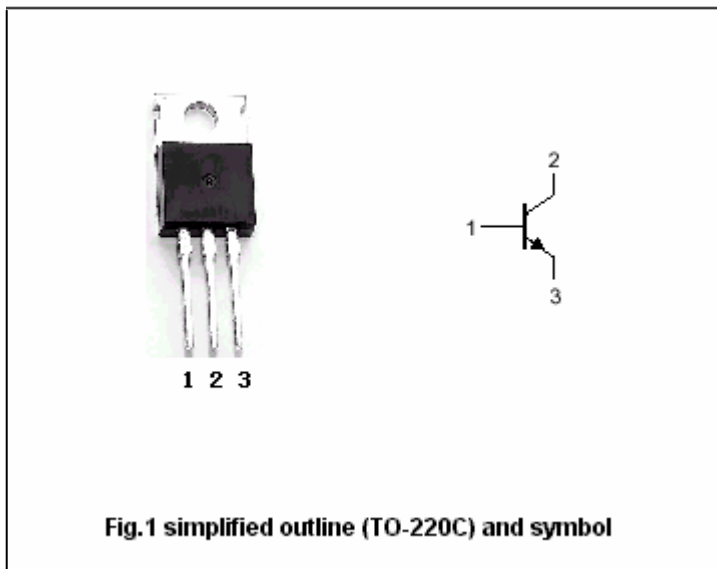

Absolute maximum ratings(Ta=25)

SYMBOL	PARAMETER	CONDITIONS	VALUE	UNIT
V _{CBO}	Collector-base voltage	Open emitter	400	V
V _{CEO}	Collector-emitter voltage	Open base	200	V
V _{EBO}	Emitter-base voltage	Open collector	6	V
I _C	Collector current		7	A
I _{CM}	Collector current-peak		12	A
I _B	Base current		4	A
P _C	Collector power dissipation	T _C =25	50	W
T _j	Junction temperature		150	
T _{stg}	Storage temperature		-55~150	

Silicon NPN Power Transistors

2SC3591

CHARACTERISTICS

T_j=25 unless otherwise specified

SYMBOL	PARAMETER	CONDITIONS	MIN	TYP.	MAX	UNIT
V _{(BR)CEO}	Collector-emitter breakdown voltage	I _C =1mA ; R _{BE} =	200			V
V _{(BR)CBO}	Collector-base breakdown voltage	I _C =1mA ; I _E =0	400			V
V _{(BR)EBO}	Emitter-base breakdown voltage	I _E =1mA ; I _C =0	6			V
V _{CEsat}	Collector-emitter saturation voltage	I _C =5A; I _B =0.5A			0.8	V
V _{BEsat}	Base-emitter saturation voltage	I _C =5A; I _B =0.5A			1.5	V
I _{CBO}	Collector cut-off current	V _{CB} =250V ; I _E =0			100	μ A
I _{EBO}	Emitter cut-off current	V _{EB} =5V; I _C =0			100	μ A
h _{FE-1}	DC current gain	I _C =1 A ; V _{CE} =1V	15			
h _{FE-2}	DC current gain	I _C =5 A ; V _{CE} =1V	10		50	
f _T	Transition frequency	I _C =0.5 A ; V _{CE} =10V	10			MHz
t _f	Fall time	V _{CC} =50V; I _C =5A; I _{B1} =-I _{B2} =0.5A ; R _L =10			0.3	μ s

Silicon NPN Power Transistors

2SC3591

PACKAGE OUTLINE

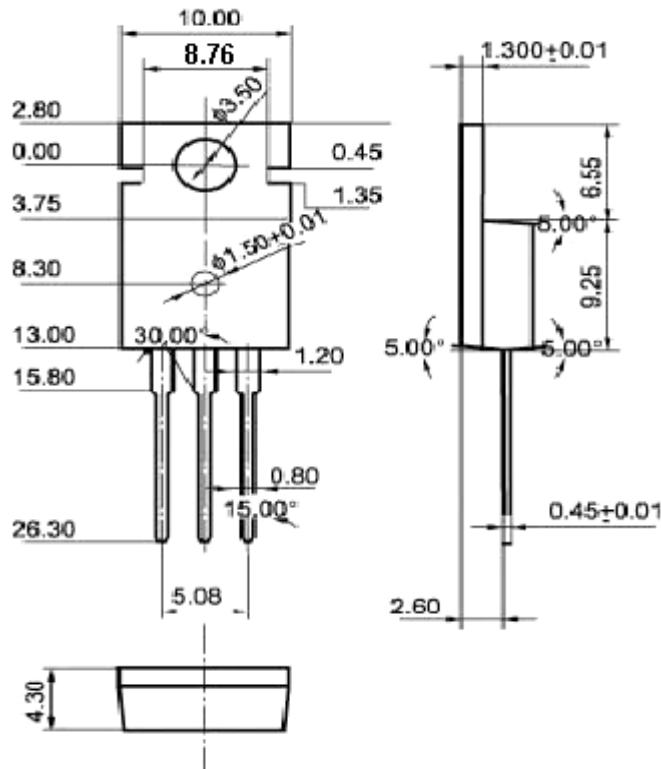

Fig.2 Outline dimensions (unindicated tolerance: ± 0.10 mm)

Silicon NPN Power Transistors

2SC3591

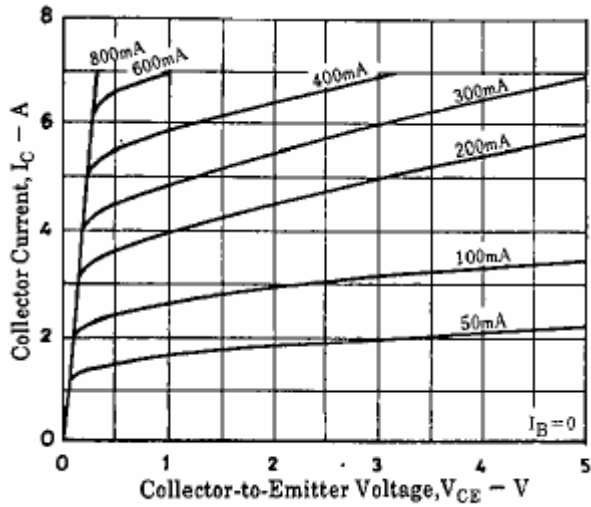

Fig.3 Static Characteristic

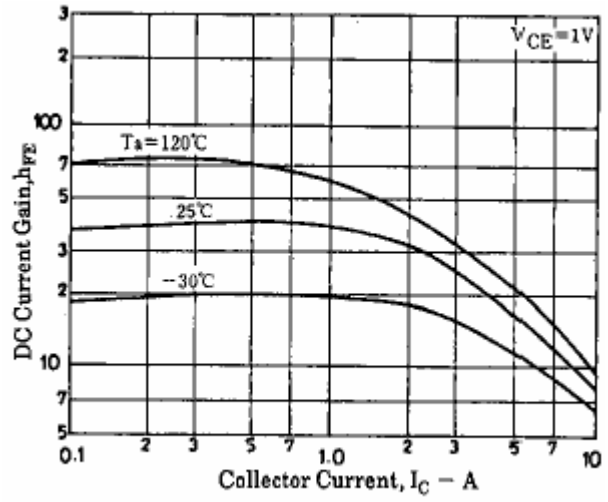

Fig.4 DC current Gain

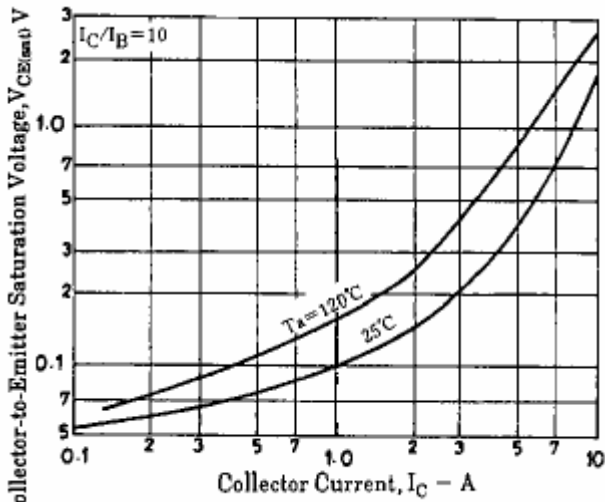

Fig.5 Collector-Emmitter Saturation Voltage

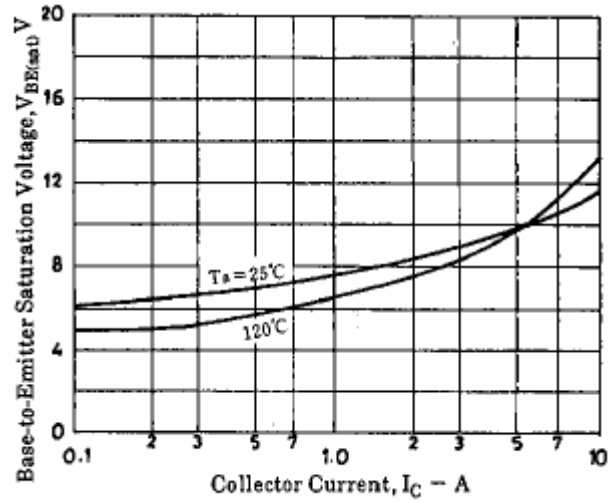

Fig.6 Base-Emmitter Saturation Voltage

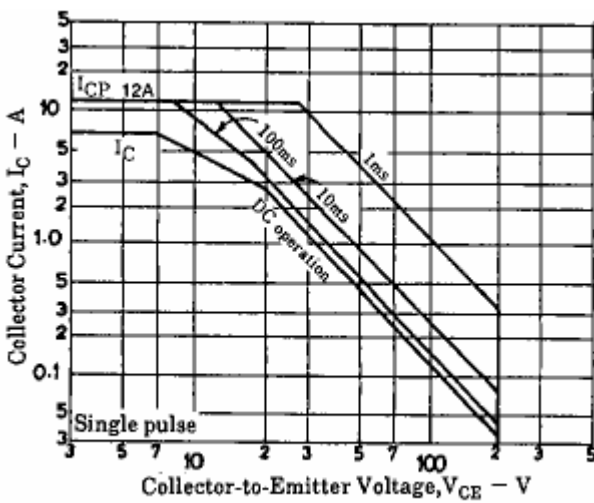

Fig.7 Safe Operating Area