

KEY FEATURES

- IP65/67 Design for Indoor or LED Outdoor Installations
- Universal Input: 90-305 VAC or 120-430 VDC
- Built-in Active PFC Function
- Free Air Convection
- High Reliability
- With Constant Current & Constant Voltage
- Output Voltage and Constant Current Level can Be Adjusted Through Internal Potentiometer
- LED Power Application
- 3-Year Product Warranty



ELECTRICAL SPECIFICATIONS

All specifications valid at normal input voltage, full load and +25°C after warm-up time unless otherwise stated.

Model No.	ALF150-12S	ALF150-24S	ALF150-36S	ALF150-48S	ALF150-54S
Max Output Wattage (W)	150W				
Input	Voltage				
	90-305 VAC or 120-430 VDC				
	Frequency (Hz)				
	47-63 Hz				
	Current (Full load)				
	2 A max. (115 VAC) / 1 A max. (230 VAC) / 0.9 A max. (277 VAC)				
Output	Inrush Current (<2ms)				
	40 A max. (115 VAC) / 60 A max. (230 VAC)				
	Leakage Current				
	<0.75 mA max.				
	Power Factor				
	PF>0.97 (115 VAC) / PF>0.95 (230 VAC) / PF>0.9 (277 VAC) at Full Load				
	Voltage (V.DC.)				
	12V	24V	36V	48V	54V
	Constant Current Range (V.DC.)				
	6 ~ 12V	12 ~ 24V	18 ~ 36V	24 ~ 48V	27 ~ 54V
	Voltage Accuracy				
	±2%				
Current (Convection) (mA) max					
12500	6250	4166	3125	2777	
Current ADJ Range (mA)					
1250~12500	625 ~ 6250	416 ~ 4166	312 ~ 3125	277 ~ 2777	
Voltage ADJ Range (V.DC.) (for IP65 Design)					
10.8 ~ 13.2V	21.6 ~ 26.4V	32.4 ~ 38.5V	43.2 ~ 50.4V	48.6 ~ 55.5V	
Line Regulation					
±1%					
Load Regulation					
±1%					
Maximum Capacitive Load					
100,000 uF	50,000 uF	33,000 uF	6,000 uF	6,000 uF	
Ripple & Noise (max.)					
100mVp-p	100mVp-p	100mVp-p	200mVp-p	200mVp-p	
Efficiency (typ.)					
90.5%	92.5%	93.5%	92.5%	92.5%	
Hold-up Time					
25 ms min.					
Safety	Agency Approvals				
UL 8750 · EN61347-1:2008 · EN61347-2-13:2006					
EMC	EMI (Conducted & Radiated Emission)				
	EN 55015 · Class B				
	EMS (Noise Immunity)				
EN 61547					
Surge					
IP65 Design :1KV L-N, 2KV L N-FG / IP67 Design :2KV L-N, 4KV L N-FG					
Protection	Over Power Protection				
	Auto recovery				
	Over Voltage Protection				
	Auto recovery				
Overt Temperature Protection					
Auto recovery					
Short Circuit Protection					
Auto recovery					
Isolation	Input-Output (V.AC)				
	3750V				
	Input-FG (V.AC)				
1880V					
Output-FG (V.AC)					
500V					

ELECTRICAL SPECIFICATIONS

All specifications valid at normal input voltage, full load and +25°C after warm-up time unless otherwise stated.

Model No.	ALF150-12S	ALF150-24S	ALF150-36S	ALF150-48S	ALF150-54S
Environment	Operating Temperature				
	-30°C...+70°C (with derating)				
	Storage Temperature				
	-40°C...+85°C				
	Temperature Coefficient				
	±0.02%/°C (0~50°C)				
Physical	Humidity				
	95% RH				
	MTBF				
	>127,000 h @ 25°C (MIL-HDBK-217F)				
	Vibration				
	10~500Hz, 5G 10min./1cycle, 60min. each along X, Y, Z axes.				
Physical	Dimension (L x W x H)				
	6.44 x 2.79 x 1.5 Inches (163.7 x 71.0 x 38.0 mm) Tolerance ±0.5 mm				
	Weight				
635 g					
Cooling Method					
Free air convection					

NOTE

- Ripple & Noise are measured at 20MHz of bandwidth with 0.1uF & 47uF parallel capacitor.
- It's recommended to add Varistor 14S561K at L / N input side in parallel.

This series has IP65 and IP67, when you place order, please be noted as ordering Part No.

Model No.	ALF150-12S	ALF150-24S	ALF150-36S	ALF150-48S	ALF150-54S	
Ordering Part No	IP65	ALF150-12S-IP65	ALF150-24S-IP65	ALF150-36S-IP65	ALF150-48S-IP65	ALF150-54S-IP65
	IP67	ALF150-12S-IP67	ALF150-24S-IP67	ALF150-36S-IP67	ALF150-48S-IP67	ALF150-54S-IP67

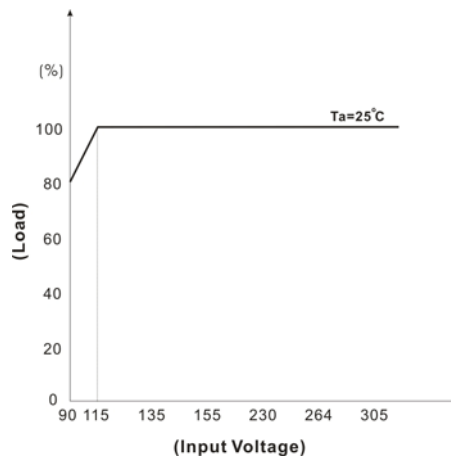
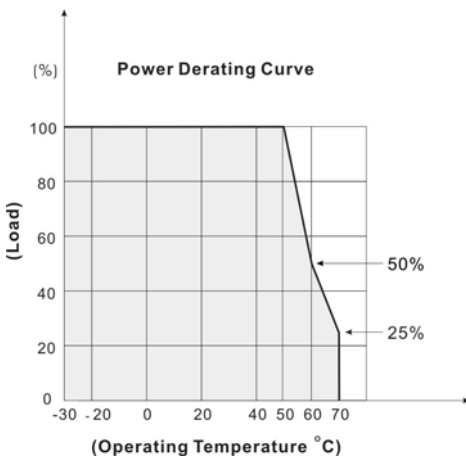
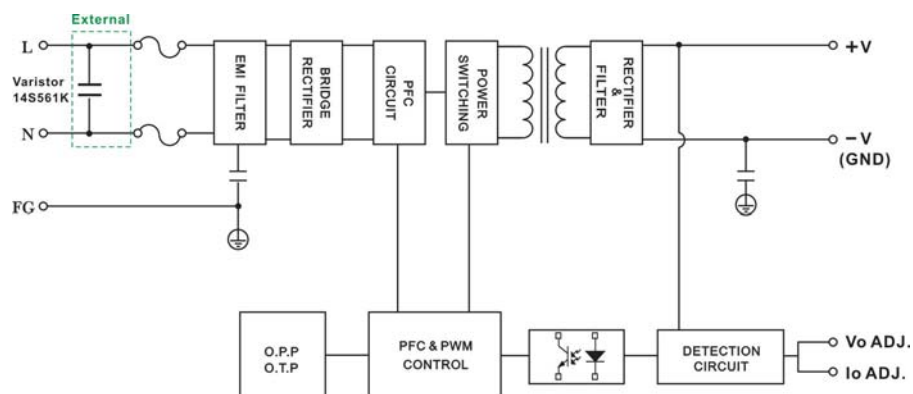
DERATING

BLOCK DIAGRAM

MECHANICAL DIMENSION (Top View)

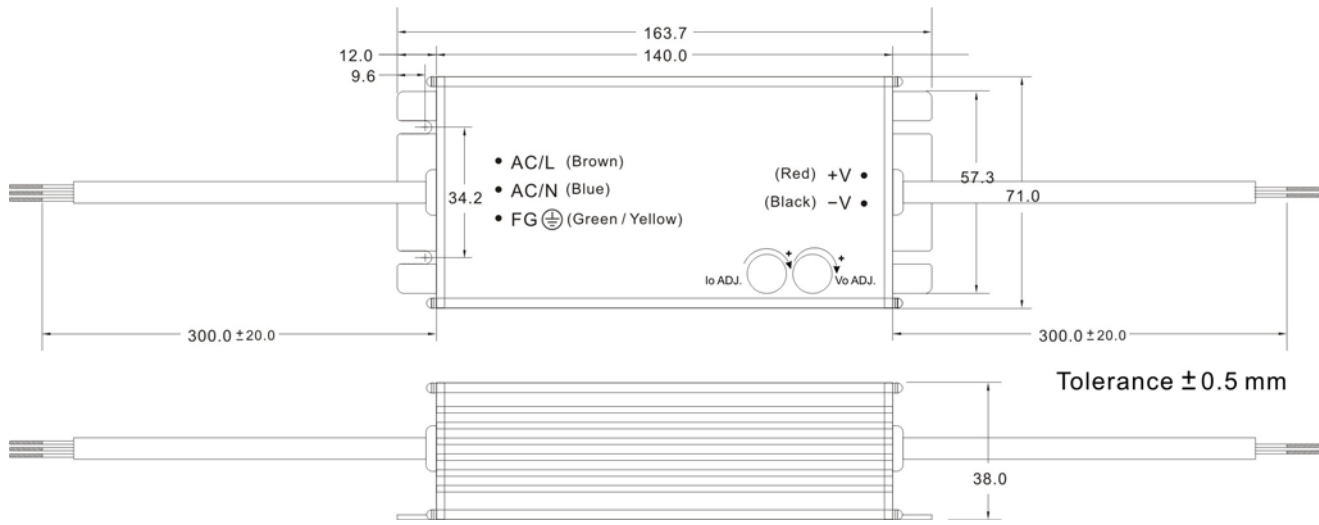
IP65 Design

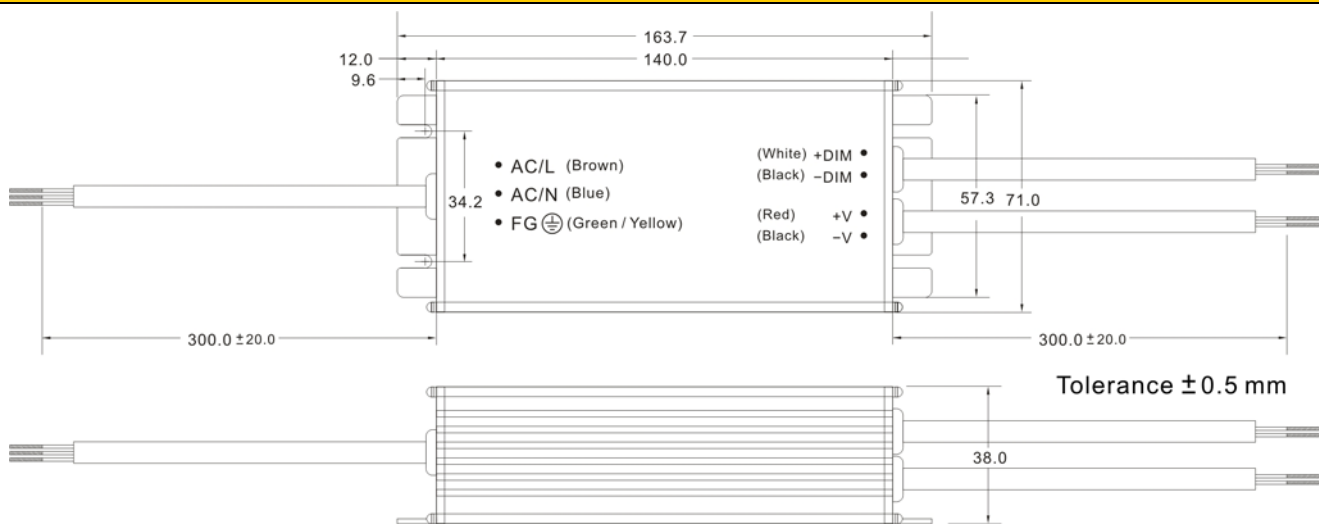

IP67 Design



ASSEMBLY INSTRUCTIONS

*U Case T=2.5mm
 Customer screws into the length of the case no higher than 0.5mm
 (Namely screw length for load plate thickness plus 3.0mm)

DIMMING OPERATION

Output constant current level can be adjusted through output cable by connecting a 3~10Vdc or 10V PWM signal between DIM+ and DIM-

I. 3~10V dimming function for output current adjustment (typ.)

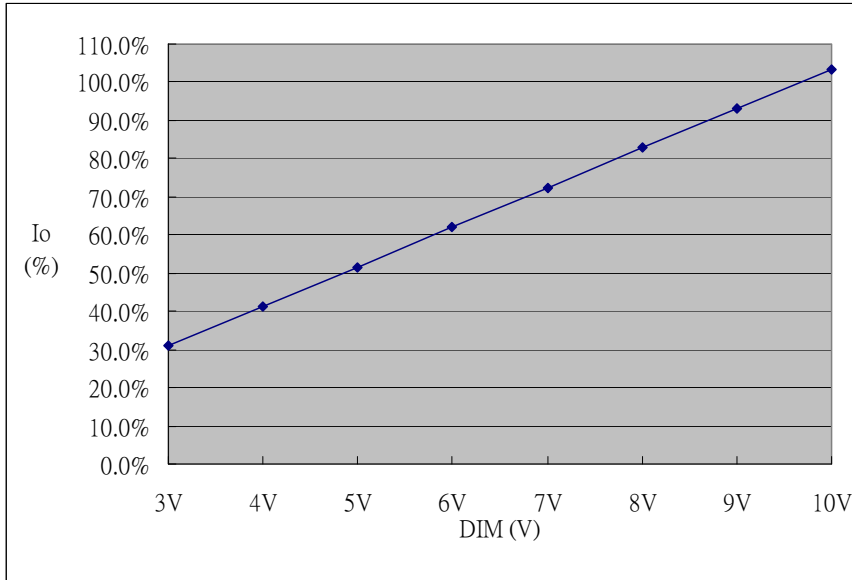

II. 10V PWM signal for output current adjustment (typ.) : Frequency range:100Hz~3KHz

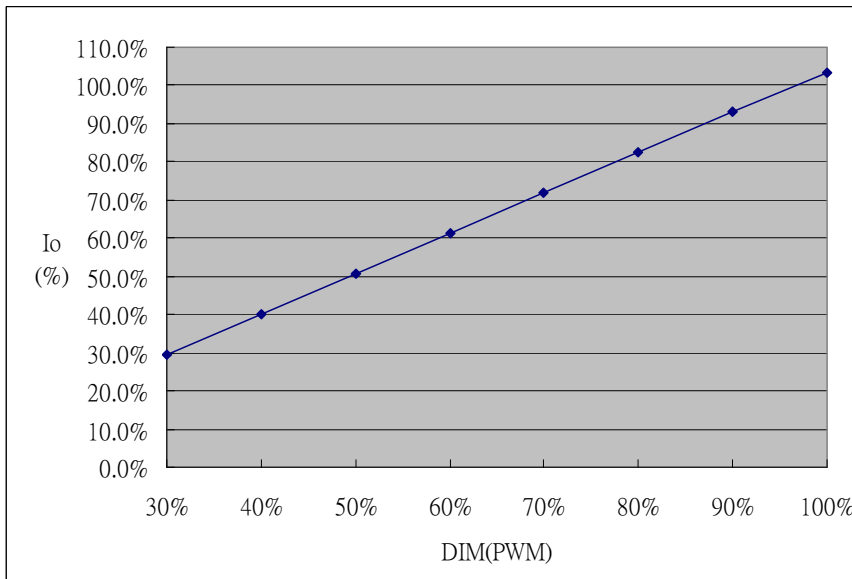

EFFICIENCY VERSUS LOAD
ALF150-12S
VIN VS Efficiency

Input Voltage (V)	90	115	180	230
Efficiency (%)	85.94	88.27	90.12	90.89
Input Voltage (V)	264	277	305	
Efficiency (%)	91.16	91.23	90.91	

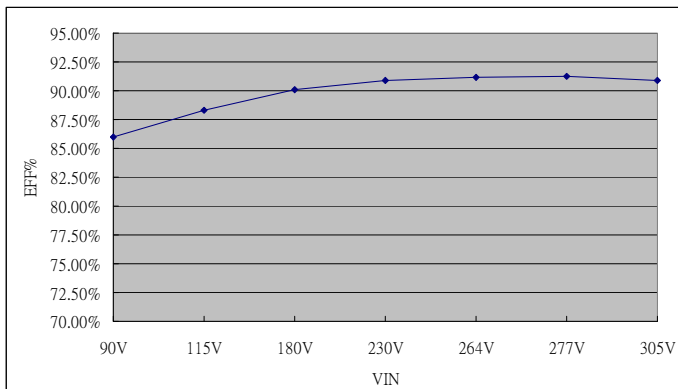
LOAD VS Efficiency

Load (%)	10	20	30	40	50
115V (%)	72.53	82.66	86.12	87.97	88.32
230V (%)	70.26	80.45	85.15	87.96	89.37
Load (%)	60	70	80	90	100
115V (%)	88.53	88.83	88.75	88.51	88.33
230V (%)	90.30	90.96	90.82	90.83	90.89

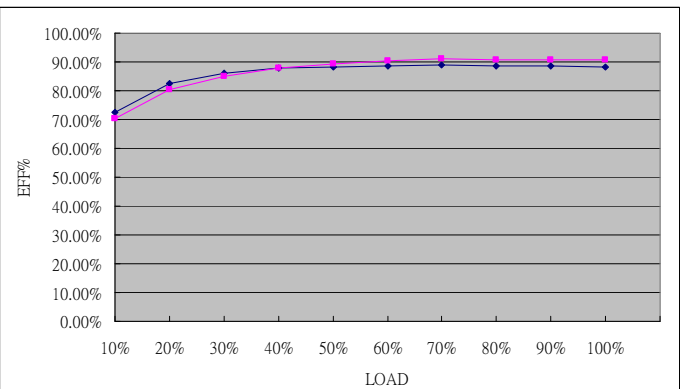
ALF150-24S
VIN VS Efficiency

Input Voltage (V)	90	115	180	230
Efficiency (%)	88.71	90.09	92.28	92.93
Input Voltage (V)	264	277	305	
Efficiency (%)	93.06	93.26	92.92	

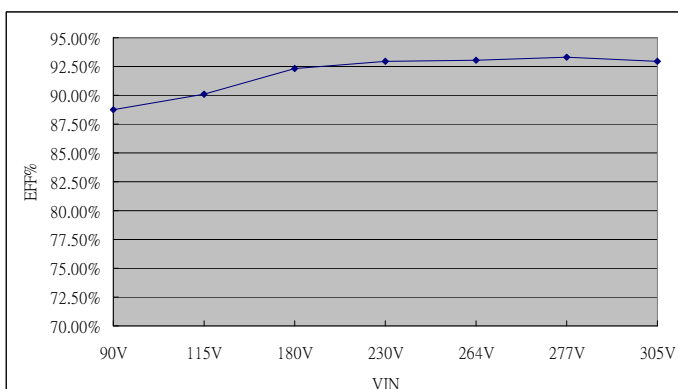

LOAD VS Efficiency

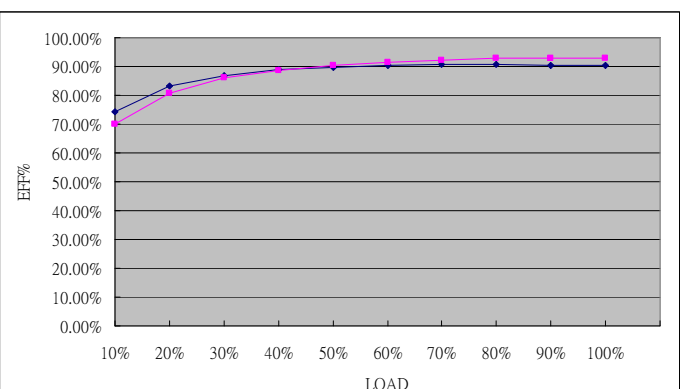
Load (%)	10	20	30	40	50
115V (%)	74.25	83.07	86.82	88.81	89.81
230V (%)	70.03	80.72	86.00	88.67	90.25
Load (%)	60	70	80	90	100
115V (%)	90.29	90.62	90.58	90.53	90.38
230V (%)	91.48	92.28	92.90	92.92	92.96

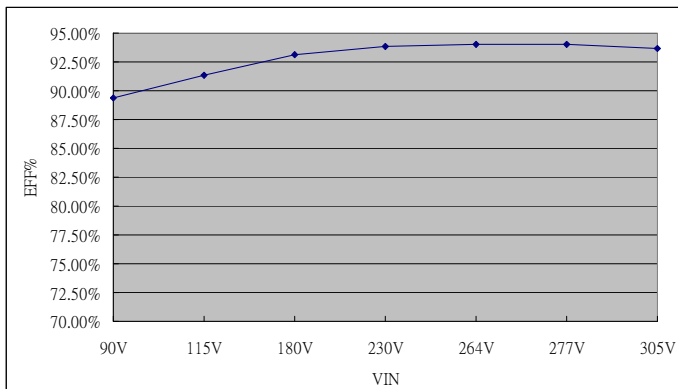

EFFICIENCY VERSUS LOAD
ALF150-36S
VIN VS Efficiency

Input Voltage (V)	90	115	180	230
Efficiency (%)	89.36	91.37	93.09	93.81
Input Voltage (V)	264	277	305	
Efficiency (%)	94.05	94.03	93.70	

LOAD VS Efficiency

Load (%)	10	20	30	40	50
115V (%)	74.93	84.24	87.87	89.92	90.59
230V (%)	70.39	81.09	86.34	89.78	90.89
Load (%)	60	70	80	90	100
115V (%)	91.10	91.60	91.28	91.65	91.58
230V (%)	92.38	93.15	93.64	93.89	93.99

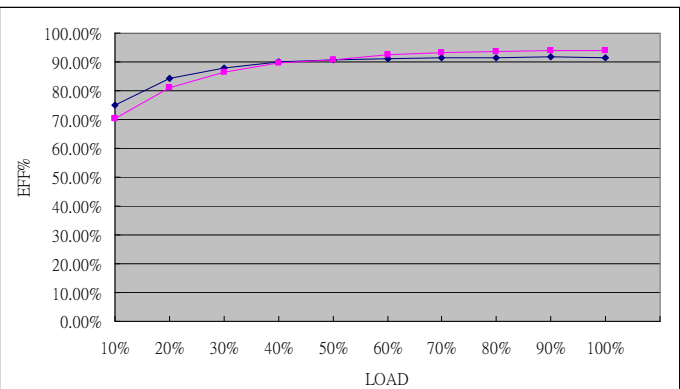
ALF150-48S
VIN VS Efficiency

Input Voltage (V)	90	115	180	230
Efficiency (%)	88.95	90.68	92.49	93.08
Input Voltage (V)	264	277	305	
Efficiency (%)	93.27	93.51	92.84	

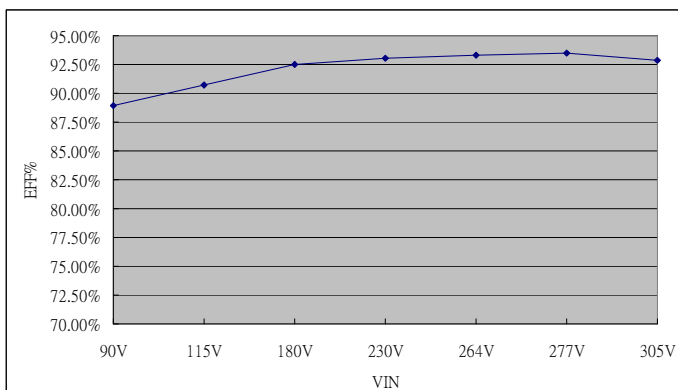
LOAD VS Efficiency

Load (%)	10	20	30	40	50
115V (%)	73.99	84.83	87.68	89.39	90.33
230V (%)	71.55	82.11	86.34	89.34	90.57
Load (%)	60	70	80	90	100
115V (%)	90.53	90.68	91.01	90.80	90.87
230V (%)	91.92	92.31	92.91	93.05	93.37

