

KEY FEATURES

- IP65/67 Design for Indoor or LED Outdoor Installations
- Universal Input: 90-305 VAC or 120-430 VDC
- Built-in Active PFC Function
- Free Air Convection
- High Reliability
- With Constant Current & Constant Voltage
- Output Voltage and Constant Current Level can Be Adjusted Through Internal Potentiometer
- LED Power Application
- 3-Year Product Warranty



IP65/67 

ELECTRICAL SPECIFICATIONS

All specifications valid at normal input voltage, full load and +25°C after warm-up time unless otherwise stated.

Model No.	ALF100-12S	ALF100-24S	ALF100-36S	ALF100-48S	ALF100-54S	
Max Output Wattage (W)	100W					
Input	Voltage	90-305 VAC or 120-430 VDC				
	Frequency (Hz)	47-63 Hz				
	Current (Full load)	1.5 A max. (115 VAC) / 0.7 A max. (230 VAC) / 0.6 A max. (277 VAC)				
	Inrush Current (<2ms)	40 A max. (115 VAC) / 60 A max. (230 VAC)				
	Leakage Current	<0.75 mA max.				
	Power Factor	PF>0.97 (115 VAC) / PF>0.9 (230 VAC) at Full Load				
Output	Voltage (V.DC.)	12V	24V	36V	48V	54V
	Constant Current Range (V.DC.)	6~12V	12~24V	18~36V	24~48V	27~54V
	Voltage Accuracy	±2%				
	Current (Convection) (mA) max	8333	4166	2777	2083	1852
	Current ADJ Range (mA)	833 ~ 8333	416 ~ 4166	277 ~ 2777	208 ~ 2083	185 ~ 1852
	Voltage ADJ Range (V.DC.) (for IP65 Design)	10.8~13.2V	21.6~26.4V	32.4~38.5V	43.2~50.4V	48.6~55.5V
	Line Regulation	±1%				
	Load Regulation	±1%				
	Maximum Capacitive Load	100,000 uF	50,000 uF	8,000 uF	4,000 uF	3,000 uF
	Ripple & Noise (max.)	100mVp-p	100mVp-p	100mVp-p	200mVp-p	200mVp-p
Efficiency (typ.)	89%	91.5%	91.5%	91.5%	91.5%	
Hold-up Time	25 ms min.					
Safety	Agency Approvals	UL 8750 · EN61347-1:2008 · EN61347-2-13:2006				
EMC	EMI (Conducted & Radiated Emission)	EN 55015 · Class B				
	EMS (Noise Immunity)	EN 61547				
	Surge	IP65 Design :1KV L-N, 2KV L N-FG / IP67 Design :2KV L-N, 4KV L N-FG				
Protection	Over Power Protection	Auto recovery				
	Over Voltage Protection	Auto recovery				
	Overt Temperature Protection	Auto recovery				
	Short Circuit Protection	Auto recovery				
Isolation	Input-Output (V.AC)	3750V				
	Input-FG (V.AC)	1880V				
	Output-FG (V.AC)	500V				

ELECTRICAL SPECIFICATIONS

All specifications valid at normal input voltage, full load and +25°C after warm-up time unless otherwise stated.

Model No.	ALF100-12S	ALF100-24S	ALF100-36S	ALF100-48S	ALF100-54S
Environment	Operating Temperature				
	-30°C...+70°C (with derating)				
	Storage Temperature				
	-40°C...+85°C				
	Temperature Coefficient				
	±0.02%/°C (0~50°C)				
Physical	Humidity				
	95% RH				
	MTBF				
	>127,000 h @ 25°C (MIL-HDBK-217F)				
	Vibration				
	10~500Hz, 5G 10min./1cycle, 60min. each along X, Y, Z axes.				
Physical	Dimension (L x W x H)				
	6.44 x 2.79 x 1.5 Inches (163.7 x 71.0 x 38.0 mm) Tolerance ±0.5 mm				
	Weight				
635 g					
Cooling Method					
Free air convection					

NOTE

1. Ripple & Noise are measured at 20MHz of bandwidth with 0.1uF & 47uF parallel capacitor.
2. It's recommended to add Varistor 14S561K at L / N input side in parallel.

This series has IP65 and IP67, when you place order, please be noted as ordering Part No.

Model No.	ALF100-12S	ALF100-24S	ALF100-36S	ALF100-48S	ALF100-54S	
Ordering Part No	IP65	ALF100-12S-IP65	ALF100-24S-IP65	ALF100-36S-IP65	ALF100-48S-IP65	ALF100-54S-IP65
	IP67	ALF100-12S-IP67	ALF100-24S-IP67	ALF100-36S-IP67	ALF100-48S-IP67	ALF100-54S-IP67

DERATING

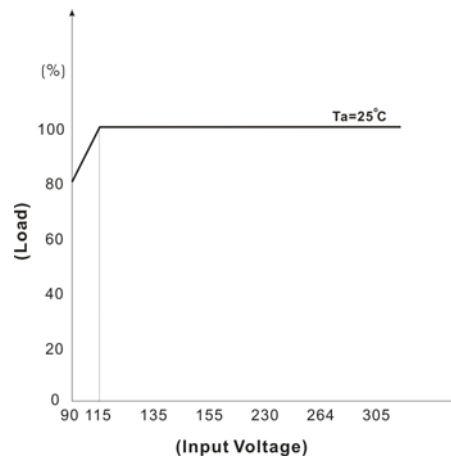
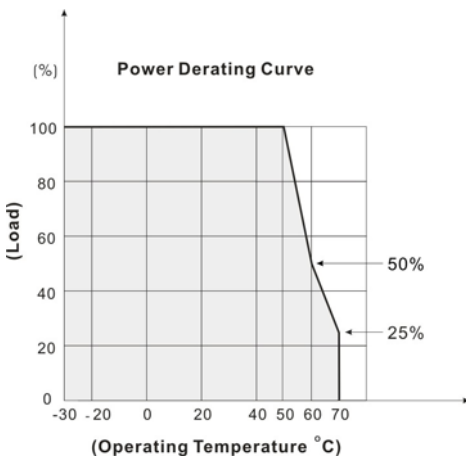

BLOCK DIAGRAM

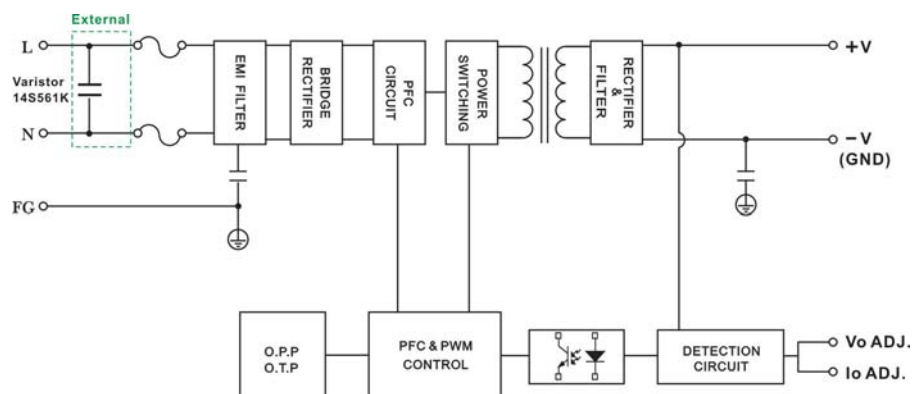

MECHANICAL DIMENSION (Top View)

IP65 Design

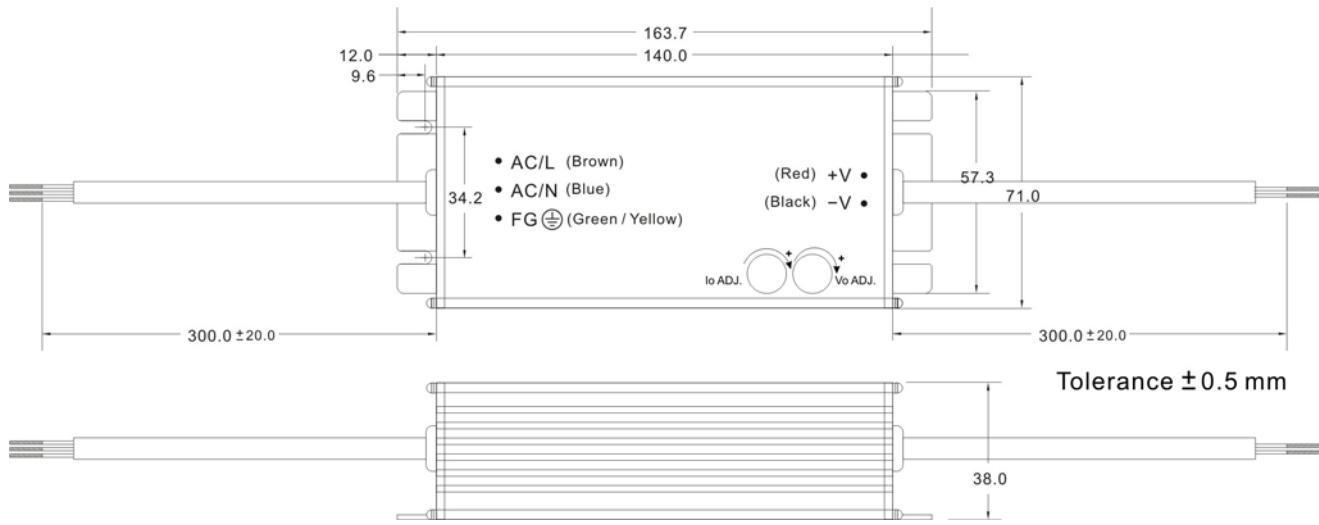

IP67 Design

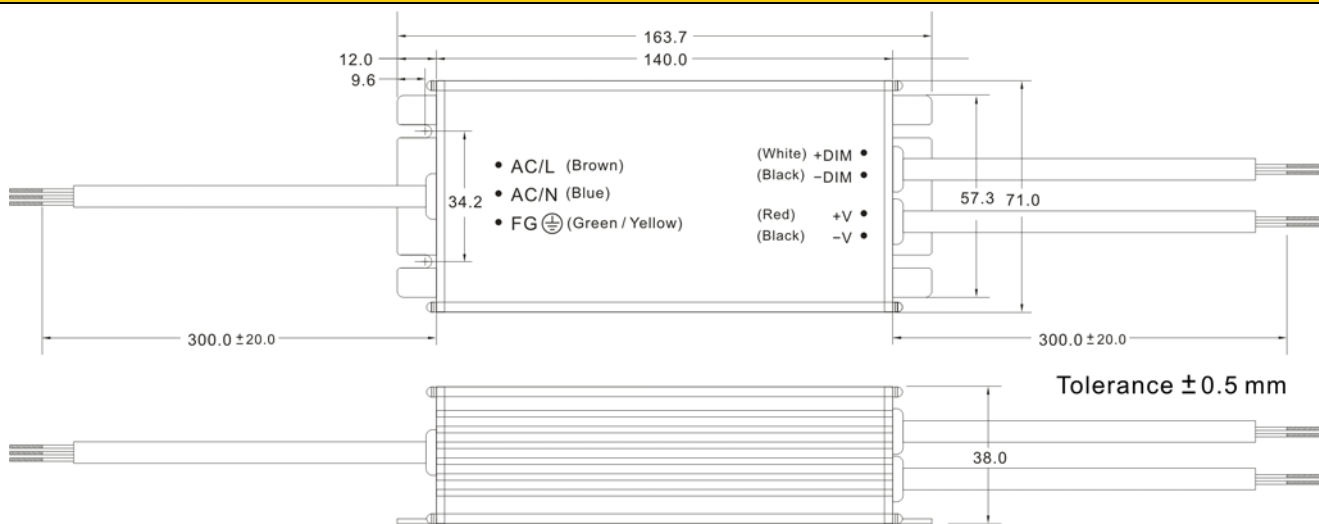

ASSEMBLY INSTRUCTIONS

*U Case T=2.5mm
Customer screws into the length of the case no higher than 0.5mm
(Namely screw length for load plate thickness plus 3.0mm)

DIMMING OPERATION

Output constant current level can be adjusted through output cable by connecting a 3~10Vdc or 10V PWM signal between DIM+ and DIM-

I. 3~10V dimming function for output current adjustment (typ.)

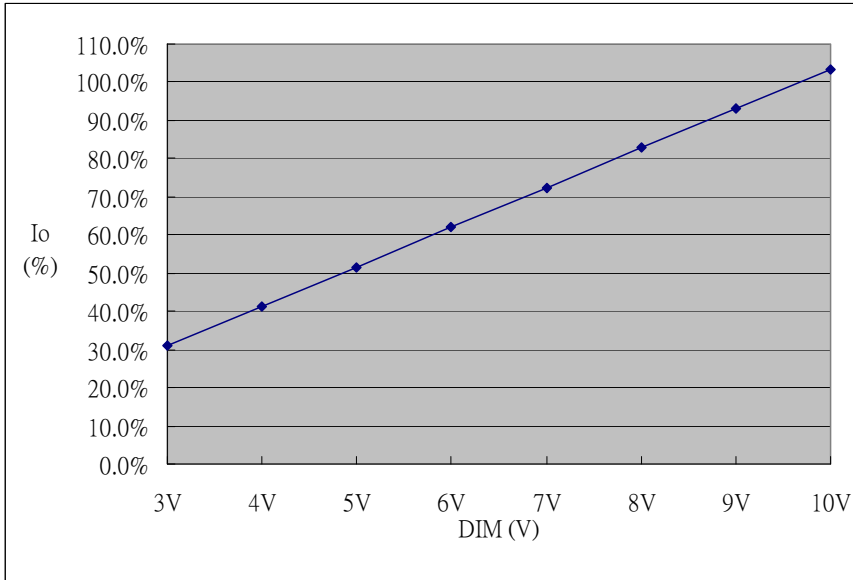

II. 10V PWM signal for output current adjustment (typ.) : Frequency range:100Hz~3KHz

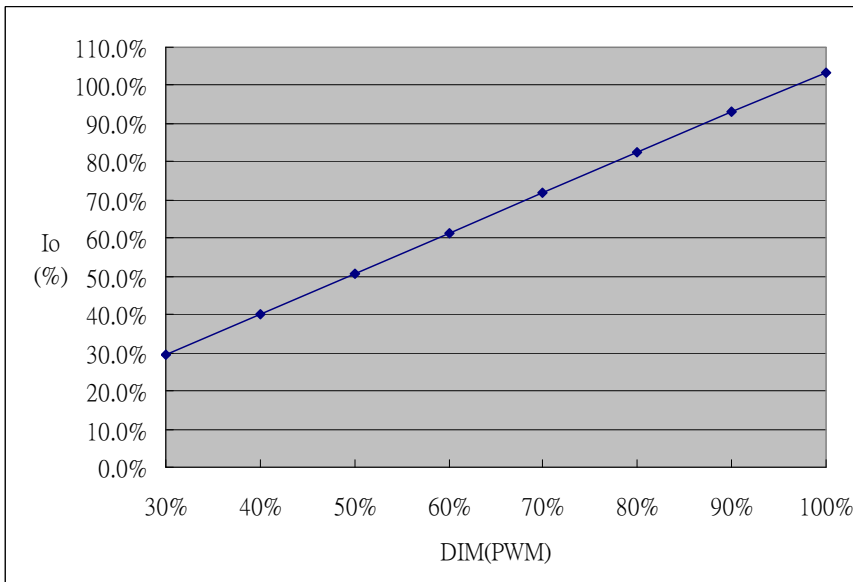

EFFICIENCY VERSUS LOAD
ALF100-12S
VIN VS Efficiency

Input Voltage (V)	90	115	180	230	264
Efficiency (%)	86.70	88.61	90.36	90.61	90.36
Input Voltage (V)	277	305			
Efficiency (%)	90.36	90.36			

LOAD VS Efficiency

Load (%)	0	10	20	30	40	50
115V (%)	0	78.83	82.61	86.10	87.62	88.25
230V (%)	0	67.92	78.75	83.11	86.31	88.09
Load (%)	60	70	80	90	100	
115V (%)	88.58	88.54	88.62	88.57	88.51	
230V (%)	89.24	89.71	89.91	90.25	90.61	

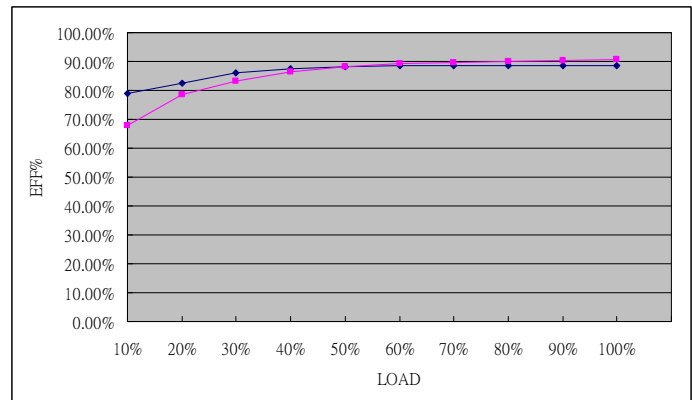
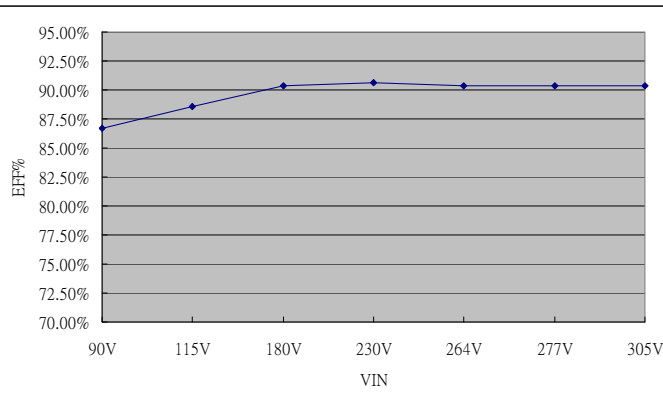
ALF100-24S
VIN VS Efficiency

Input Voltage (V)	90	115	180	230	264
Efficiency (%)	88.71	90.65	92.27	92.27	92.14
Input Voltage (V)	277	305			
Efficiency (%)	92.14	92.40			

LOAD VS Efficiency

Load (%)	0	10	20	30	40	50
115V (%)	0	71.91	82.20	86.04	87.80	88.81
230V (%)	0	65.13	76.60	82.51	85.92	87.91
Load (%)	60	70	80	90	100	
115V (%)	89.54	90.26	90.12	90.34	90.43	
230V (%)	89.28	90.61	91.47	92.20	92.31	

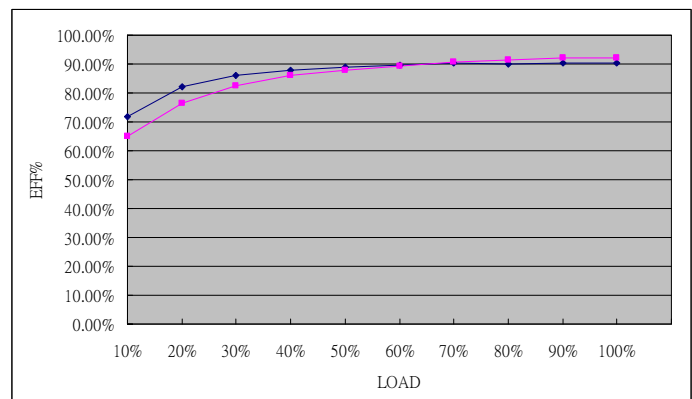
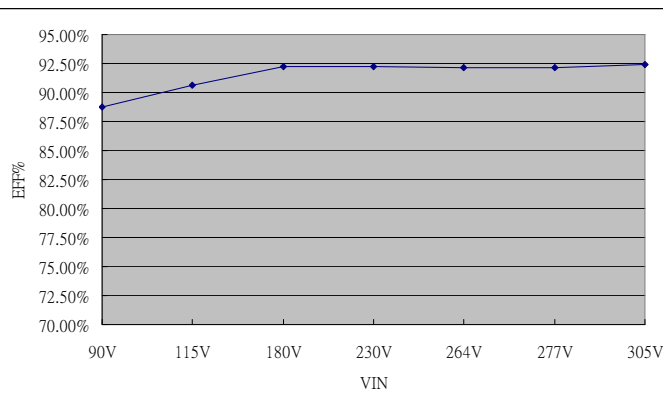

EFFICIENCY VERSUS LOAD
ALF100-36S
VIN VS Efficiency

Input Voltage (V)	90	115	180	230	264
Efficiency (%)	88.82	90.67	92.10	92.01	91.42
Input Voltage (V)	277	305			
Efficiency (%)	91.36	91.53			

LOAD VS Efficiency

Load (%)	0	10	20	30	40	50
115V (%)	0	73.59	82.19	85.65	87.60	89.01
230V (%)	0	65.58	76.12	81.72	85.42	87.77
Load (%)	60	70	80	90	100	
115V (%)	89.29	90.38	90.80	90.97	90.89	
230V (%)	88.78	89.89	91.24	91.68	92.43	

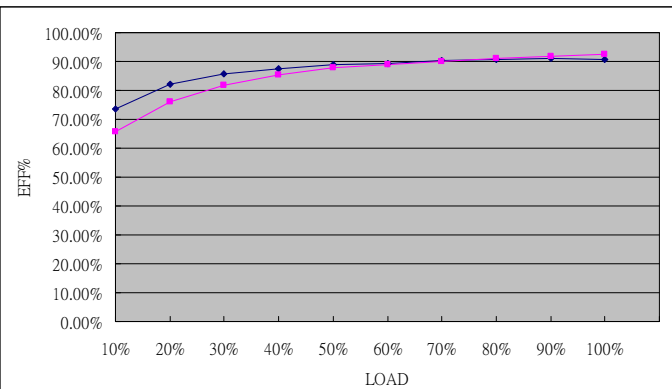
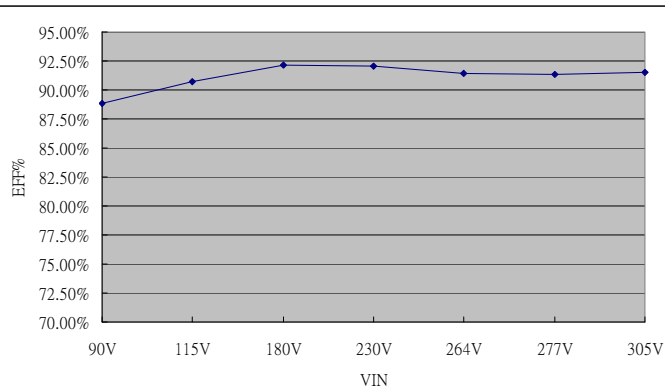
ALF100-48S
VIN VS Efficiency

Input Voltage (V)	90	115	180	230	264
Efficiency (%)	89.15	90.83	92.09	92.01	91.42
Input Voltage (V)	277	305			
Efficiency (%)	91.25	91.25			

LOAD VS Efficiency

Load (%)	0	10	20	30	40	50
115V (%)	0	71.89	81.99	85.76	87.48	88.59
230V (%)	0	61.76	75.28	80.88	84.90	87.04
Load (%)	60	70	80	90	100	
115V (%)	89.48	90.16	90.40	90.73	90.85	
230V (%)	88.77	89.95	90.66	91.27	92.01	

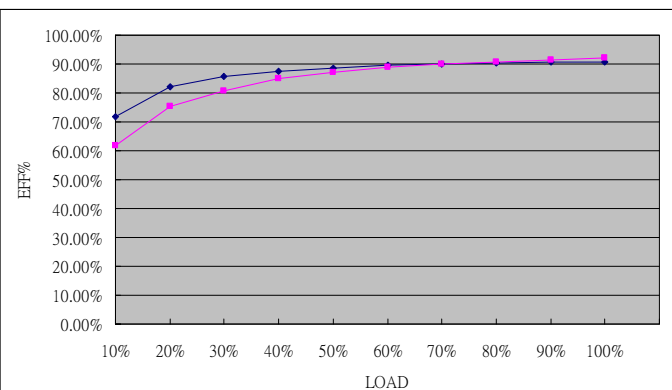
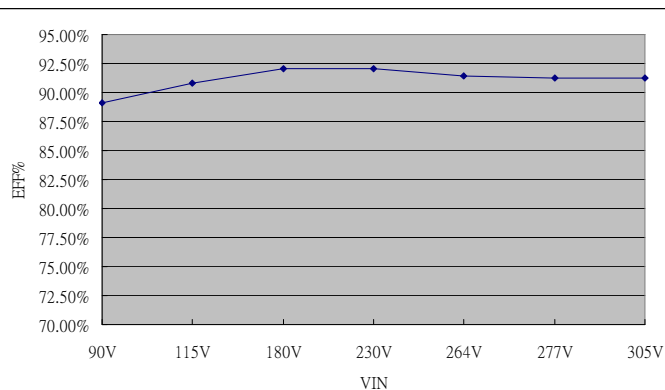

EFFICIENCY VERSUS LOAD

ALF100-54S

VIN VS Efficiency

Input Voltage (V)	90	115	180	230	264
Efficiency (%)	89.11	91.04	92.56	92.82	92.73
Input Voltage (V)	277	305			
Efficiency (%)	92.58	92.22			

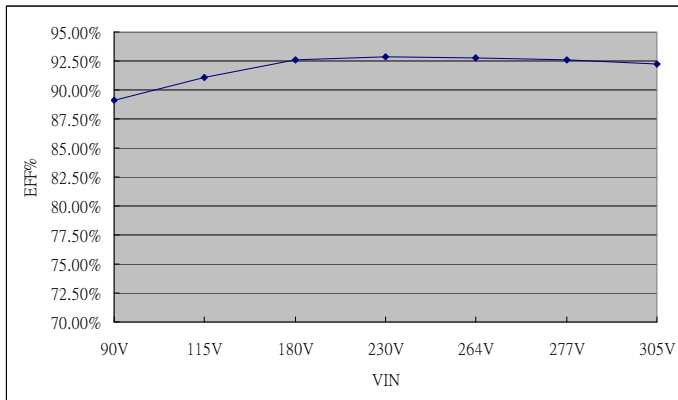

LOAD VS Efficiency

Load (%)	0	10	20	30	40	50
115V (%)	0	67.86	77.81	84.01	86.71	88.96
230V (%)	0	58.78	73.10	81.29	84.94	87.15
Load (%)	60	70	80	90	100	
115V (%)	89.80	90.32	90.75	91.12	91.04	
230V (%)	89.06	90.30	91.60	92.93	92.82	

