



2SC5374A

RF Transistor 10V, 100mA, $f_T=5.2\text{GHz}$, NPN Single SMCP

ON Semiconductor®

<http://onsemi.com>

Features

- High gain : $|S_{21e}|^2=10.5\text{dB typ (f=1GHz)}$
- High cut-off frequency : $f_T=5.2\text{GHz typ}$

Specifications

Absolute Maximum Ratings at $T_a=25^\circ\text{C}$

Parameter	Symbol	Conditions	Ratings	Unit
Collector-to-Base Voltage	V_{CBO}		20	V
Collector-to-Emitter Voltage	V_{CEO}		10	V
Emitter-to-Base Voltage	V_{EBO}		2	V
Collector Current	I_C		100	mA
Collector Dissipation	P_C		100	mW
Junction Temperature	T_j		150	$^\circ\text{C}$
Storage Temperature	T_{stg}		-55 to +150	$^\circ\text{C}$

Stresses exceeding Maximum Ratings may damage the device. Maximum Ratings are stress ratings only. Functional operation above the Recommended Operating Conditions is not implied. Extended exposure to stresses above the Recommended Operating Conditions may affect device reliability.

Package Dimensions

unit : mm (typ)

7027A-002

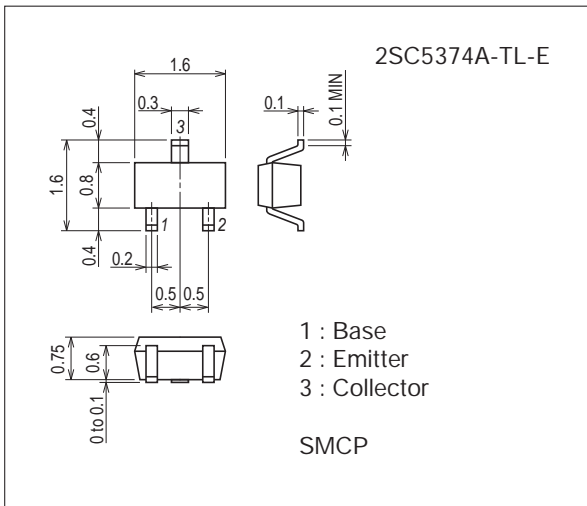

Product & Package Information

- Package : SMCP
- JEITA, JEDEC : SC-75, SOT-416
- Minimum Packing Quantity : 3,000 pcs./reel

Packing Type: TL

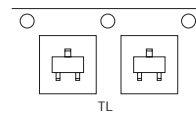

Marking

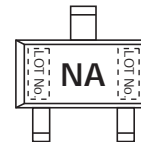

Electrical Connection

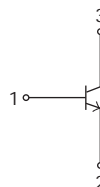

2SC5374A

Electrical Characteristics at Ta=25°C

Parameter	Symbol	Conditions	Ratings			Unit
			min	typ	max	
Collector Cutoff Current	I_{CBO}	$V_{CB}=10V, I_E=0A$			1.0	μA
Emitter Cutoff Current	I_{EBO}	$V_{EB}=1V, I_C=0A$			10	μA
DC Current Gain	h_{FE1}	$V_{CE}=3V, I_C=7mA$	110		180	
	h_{FE2}	$V_{CE}=3V, I_C=30mA$	100			
Gain-Bandwidth Product	f_T	$V_{CE}=3V, I_C=7mA$	3	5.2		GHz
Output Capacitance	C_{ob}	$V_{CB}=3V, f=1MHz$		1.0	1.5	pF
Reverse Transfer Capacitance	C_{re}			0.7		pF
Forward Transfer Gain	$ S_{21e} ^2$	$V_{CE}=3V, I_C=7mA, f=1GHz$	8	10.5		dB
Noise Figure	NF	$V_{CE}=3V, I_C=7mA, f=1GHz$		1.4	2.5	dB

Ordering Information

Device	Package	Shipping	memo
2SC5374A-TL-E	SMCP	3,000pcs./reel	Pb Free

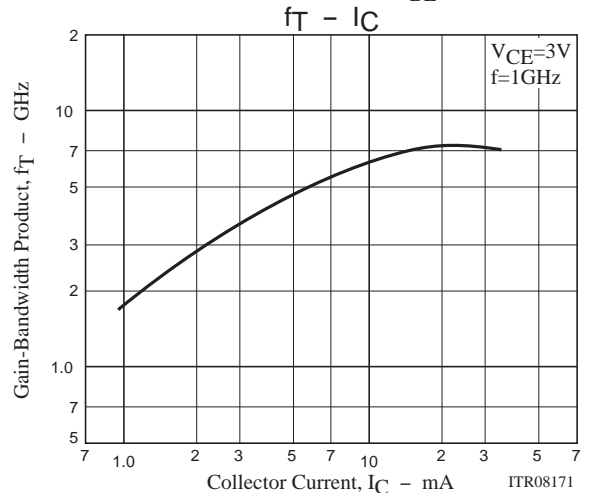
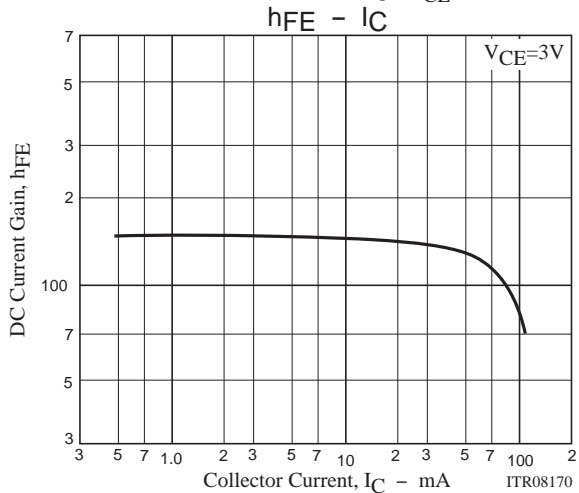
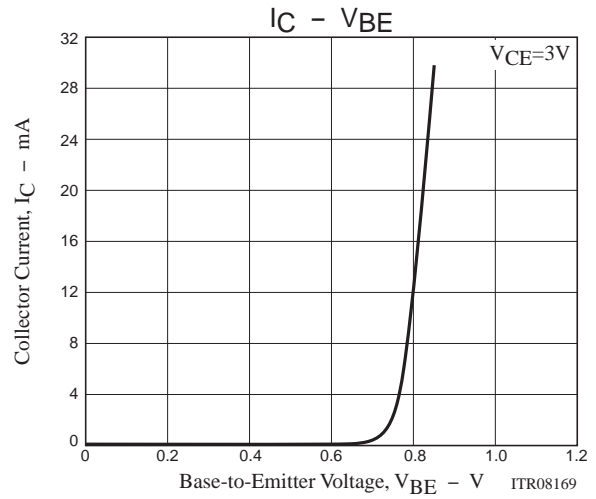
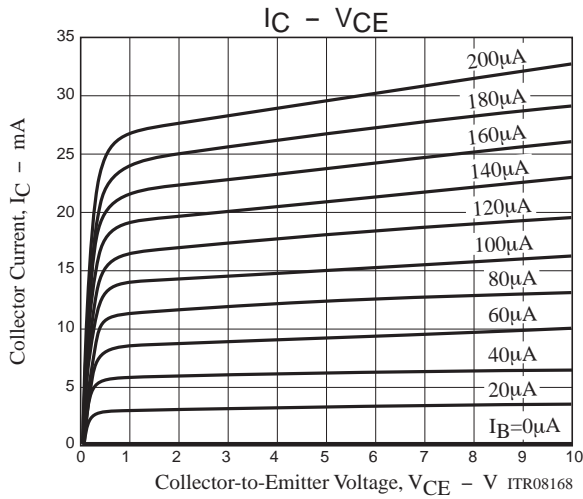

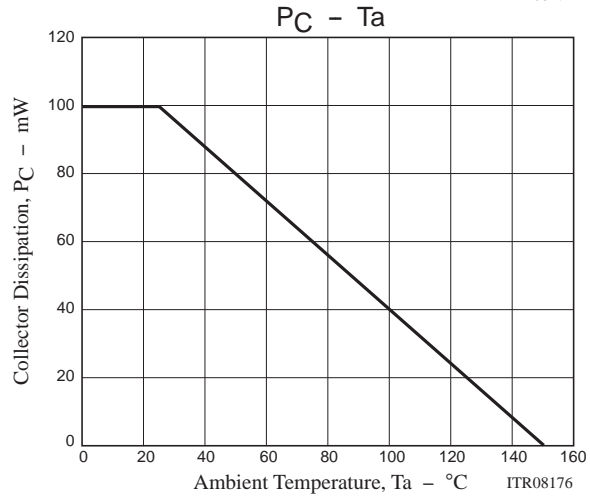
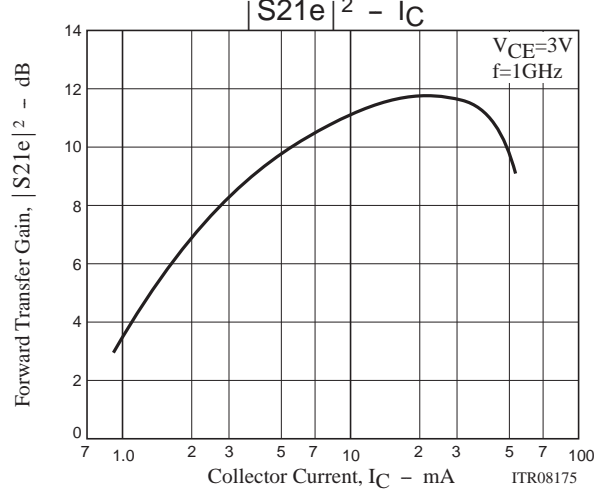
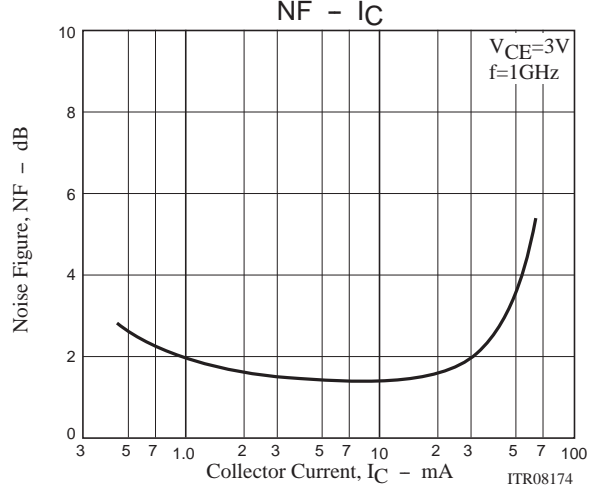
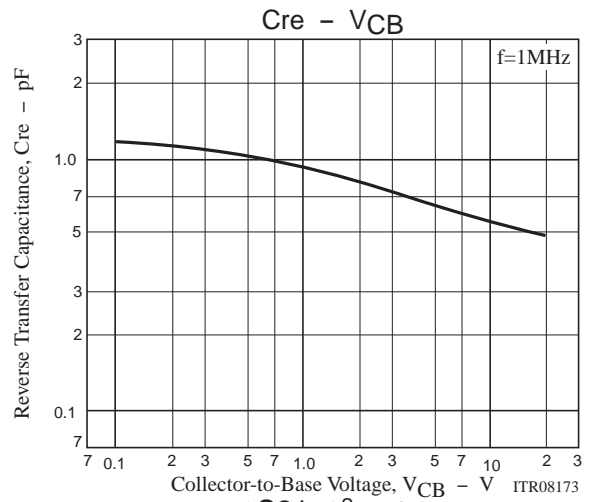
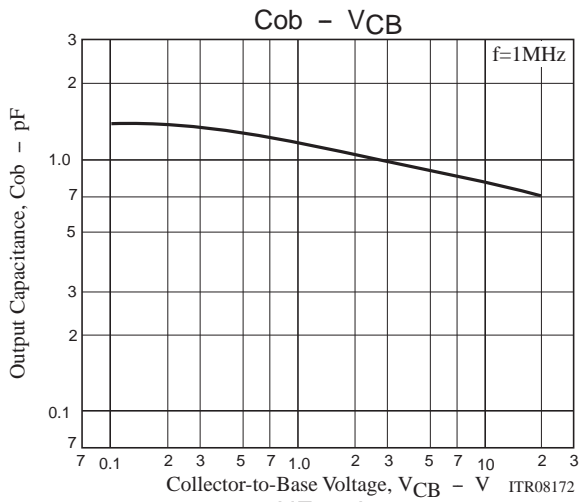

2SC5374A

S Parameter

S11e

f=100MHz, 200MHz to 2000MHz(200MHz Step)

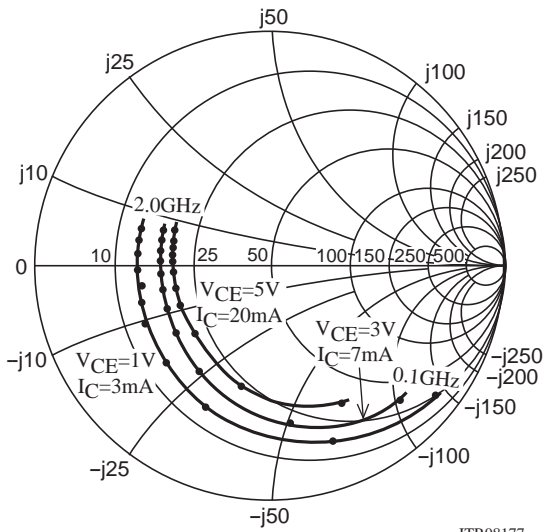

ITR08177

S21e

f=100MHz, 200MHz to 2000MHz(200MHz Step)

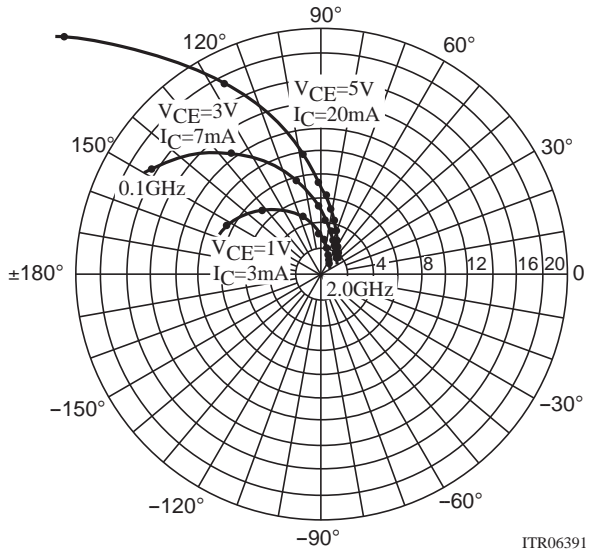

ITR06391

S12e

f=100MHz, 200MHz to 2000MHz(200MHz Step)

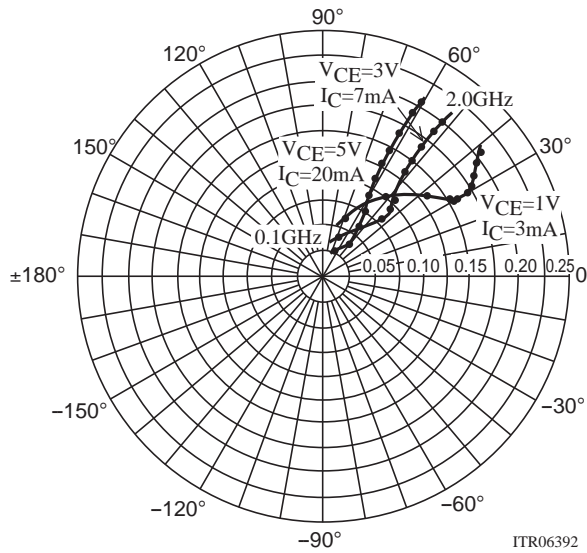

ITR06392

S22e

f=100MHz, 200MHz to 2000MHz(200MHz Step)

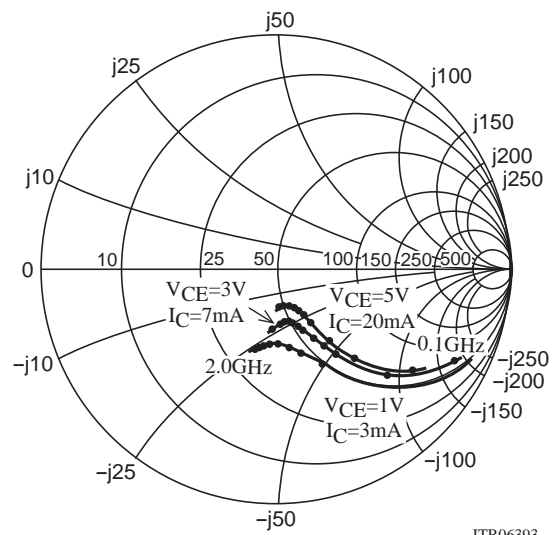

ITR06393

2SC5374A

S Parameters (Common emitter)

$V_{CE}=1V, I_C=3mA, Z_O=50\Omega$

Freq(MHz)	S11	$\angle S11$	S21	$\angle S21$	S12	$\angle S12$	S22	$\angle S22$
100	0.875	-40.6	8.627	152.3	0.062	67.9	0.918	-23.4
200	0.785	-71.6	6.874	132.5	0.101	52.1	0.748	-41.7
400	0.651	-114.8	4.701	107.3	0.135	37.1	0.537	-57.6
600	0.613	-136.9	3.365	92.8	0.152	31.1	0.430	-65.6
800	0.581	-153.9	2.716	81.9	0.155	29.9	0.361	-74.3
1000	0.568	-164.2	2.218	73.4	0.161	30.0	0.326	-80.2
1200	0.556	-172.0	1.863	66.2	0.170	30.5	0.300	-86.1
1400	0.563	-178.1	1.626	59.6	0.177	32.7	0.297	-92.3
1600	0.558	175.4	1.473	53.9	0.185	35.4	0.306	-96.5
1800	0.560	168.9	1.345	48.1	0.196	37.4	0.313	-100.6
2000	0.567	163.1	1.230	42.5	0.205	38.0	0.335	-102.9

$V_{CE}=3V, I_C=7mA, Z_O=50\Omega$

Freq(MHz)	S11	$\angle S11$	S21	$\angle S21$	S12	$\angle S12$	S22	$\angle S22$
100	0.789	-48.3	16.232	147.7	0.039	66.1	0.862	-27.2
200	0.670	-83.7	12.431	126.4	0.061	53.0	0.673	-44.6
400	0.552	-123.8	7.607	104.7	0.081	45.2	0.438	-59.1
600	0.522	-145.3	5.401	92.7	0.094	45.9	0.333	-65.1
800	0.504	-158.5	4.155	84.1	0.106	48.2	0.290	-68.7
1000	0.488	-169.1	3.425	77.1	0.121	49.1	0.270	-71.0
1200	0.478	-176.1	2.849	71.0	0.136	51.0	0.253	-74.7
1400	0.481	178.4	2.511	65.6	0.152	52.2	0.239	-79.6
1600	0.478	172.7	2.237	60.7	0.167	52.8	0.240	-82.8
1800	0.492	167.4	2.016	55.5	0.185	53.2	0.245	-86.7
2000	0.489	162.0	1.844	50.5	0.200	52.7	0.248	-90.0

$V_{CE}=5V, I_C=20mA, Z_O=50\Omega$

Freq(MHz)	S11	$\angle S11$	S21	$\angle S21$	S12	$\angle S12$	S22	$\angle S22$
100	0.643	-66.4	26.381	137.4	0.029	62.8	0.748	-36.3
200	0.530	-104.6	17.543	116.5	0.041	54.2	0.531	-52.5
400	0.459	-140.3	9.835	98.9	0.058	55.4	0.322	-62.7
600	0.447	-157.2	6.805	89.4	0.074	59.2	0.246	-65.5
800	0.440	-168.4	5.210	82.4	0.092	61.4	0.213	-68.6
1000	0.434	-175.9	4.194	76.6	0.110	61.9	0.199	-70.2
1200	0.437	177.1	3.518	71.5	0.129	62.3	0.191	-72.9
1400	0.437	173.0	3.077	66.7	0.148	61.8	0.184	-76.5
1600	0.438	168.4	2.730	62.5	0.166	61.6	0.181	-80.9
1800	0.439	164.2	2.459	58.0	0.186	60.7	0.186	-84.8
2000	0.444	159.1	2.249	53.5	0.203	59.5	0.192	-87.3

Embossed Taping Specification

2SC5374A-TL-E

1. Packing Format

Package Name	Carrier Tape Type	Maximum Number of devices contained (pcs)			Packing format	
		Reel	Inner box	Outer box	Inner BOX (C-1)	Outer BOX (A-7)
SMCP	SMCP	3,000	15,000	90,000	5 reels contained Dimensions:mm (external) 183×72×185	6 inner boxes contained Dimensions:mm (external) 440×195×210

Packing method

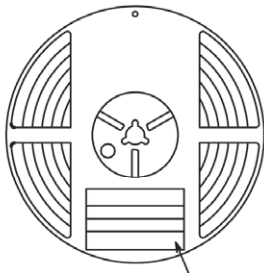

Reel label

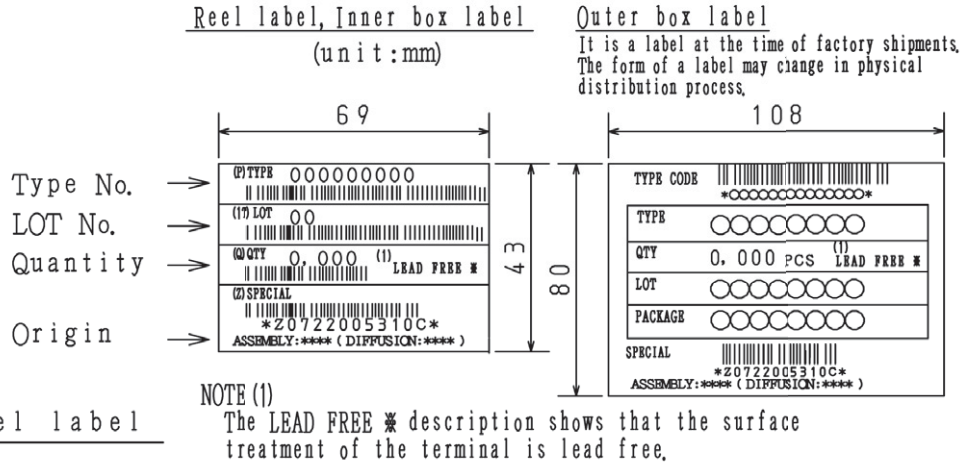

Label	JEITA Phase
.....	JEITA Phase 3

2. Taping configuration

2-1. Carrier tape size (unit:mm)

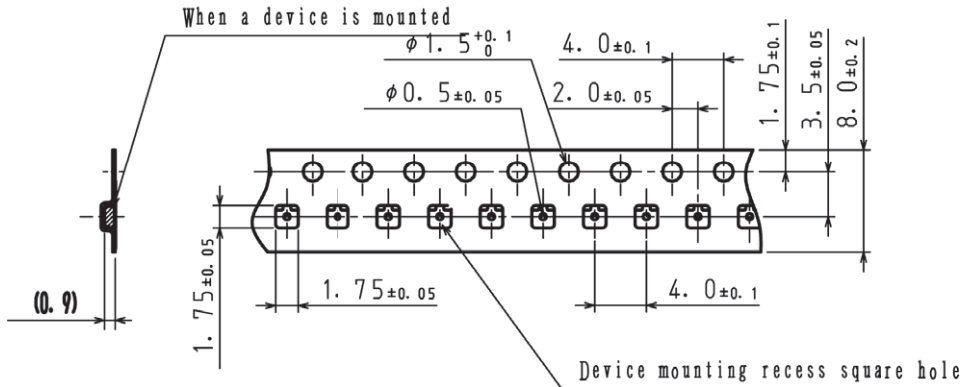

2-2. Device placement direction

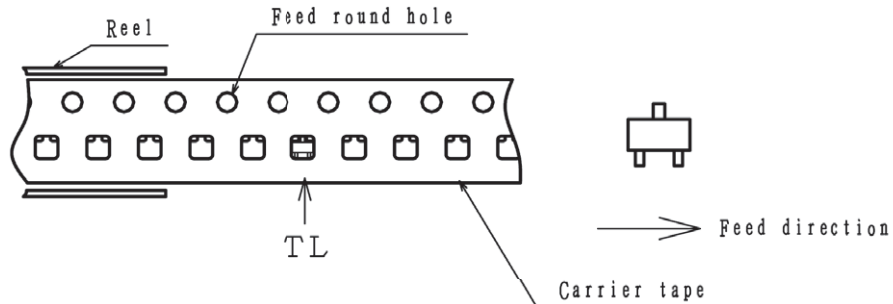

Those with one electrode terminal on the feed hole side.....TL

2SC5374A

Outline Drawing

2SC5374A-TL-E

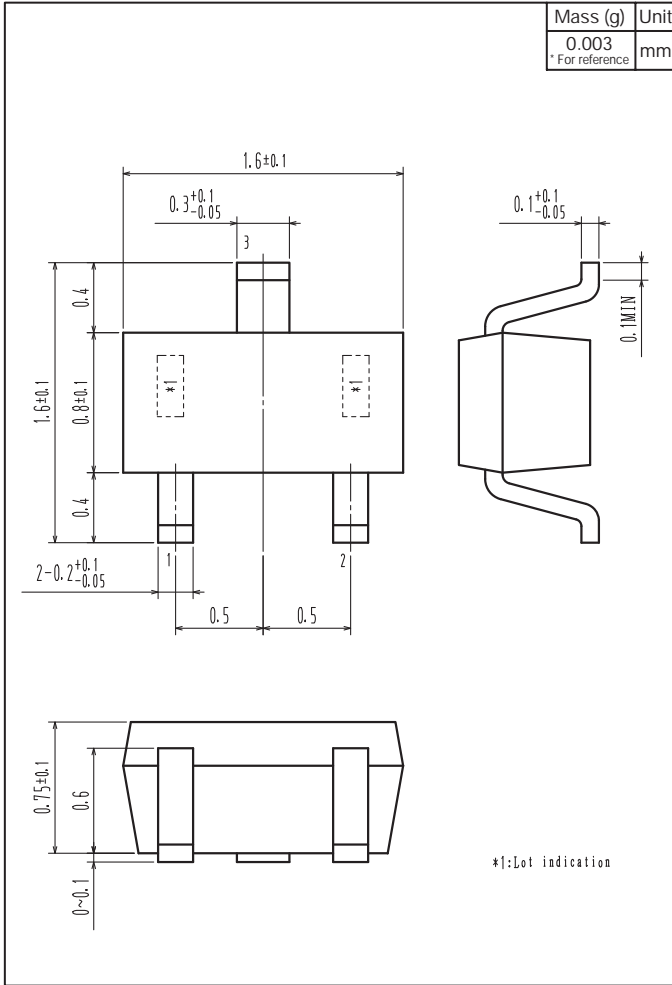

Land Pattern Example

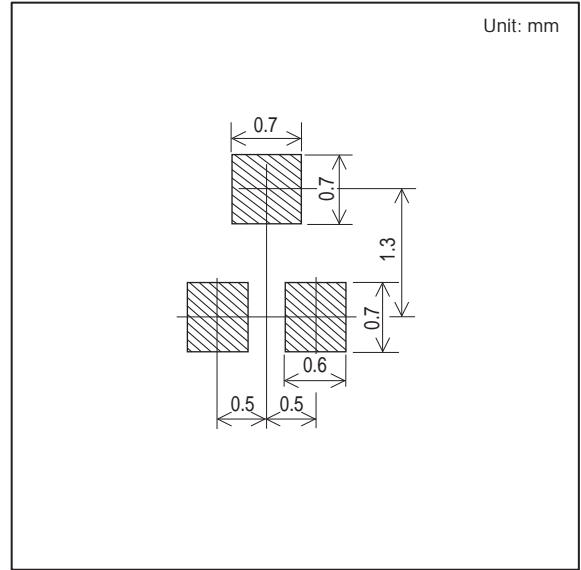

ON Semiconductor and the ON logo are registered trademarks of Semiconductor Components Industries, LLC (SCILLC). SCILLC owns the rights to a number of patents, trademarks, copyrights, trade secrets, and other intellectual property. A listing of SCILLC's product/patent coverage may be accessed at www.onsemi.com/site/pdf/Patent-Marking.pdf. SCILLC reserves the right to make changes without further notice to any products herein. SCILLC makes no warranty, representation or guarantee regarding the suitability of its products for any particular purpose, nor does SCILLC assume any liability arising out of the application or use of any product or circuit, and specifically disclaims any and all liability, including without limitation special, consequential or incidental damages. "Typical" parameters which may be provided in SCILLC data sheets and/or specifications can and do vary in different applications and actual performance may vary over time. All operating parameters, including "Typicals" must be validated for each customer application by customer's technical experts. SCILLC does not convey any license under its patent rights nor the rights of others. SCILLC products are not designed, intended, or authorized for use as components in systems intended for surgical implant into the body, or other applications intended to support or sustain life, or for any other application in which the failure of the SCILLC product could create a situation where personal injury or death may occur. Should Buyer purchase or use SCILLC products for any such unintended or unauthorized application, Buyer shall indemnify and hold SCILLC and its officers, employees, subsidiaries, affiliates, and distributors harmless against all claims, costs, damages, and expenses, and reasonable attorney fees arising out of, directly or indirectly, any claim of personal injury or death associated with such unintended or unauthorized use, even if such claim alleges that SCILLC was negligent regarding the design or manufacture of the part. SCILLC is an Equal Opportunity/Affirmative Action Employer. This literature is subject to all applicable copyright laws and is not for resale in any manner.