

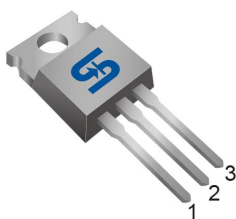

TO-220

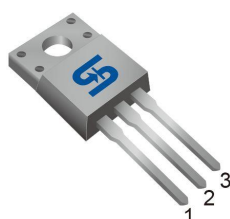

ITO-220



**Pin Definition:**

1. Gate
2. Drain
3. Source

**Key Parameter Performance**

Parameter	Value	Unit
$V_{DS}$	-60	V
$R_{DS(on)}$ (max)	$V_{GS} = -10V$	48
	$V_{GS} = -4.5V$	65
$Q_g$	22.4	nC

TO-251S (IPAK)

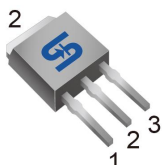

TO-252 (DPAK)

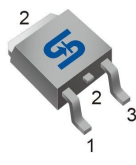

**Ordering Information**

Part No.	Package	Packing
TSM480P06CZ C0G	TO-220	50pcs / Tube
TSM480P06CI C0G	ITO-220	50pcs / Tube
TSM480P06CH X0G	TO-251S	75pcs / Tube
TSM480P06CP ROG	TO-252	2.5kpcs / 13+Reel

**Note:** %G+denotes for Halogen- and Antimony-free as those which contain <900ppm bromine, <900ppm chlorine (<1500ppm total Br + Cl) and <1000ppm antimony compounds

**Block Diagram**

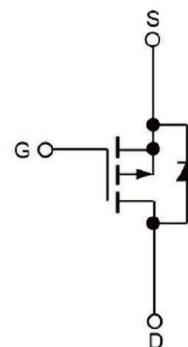

P-Channel MOSFET

**Absolute Maximum Ratings** ( $T_c = 25^\circ C$  unless otherwise noted)

Parameter	Symbol	Limit			Unit
		IPAK/DPAK	ITO-220	TO-220	
Drain-Source Voltage	$V_{DS}$	-60			V
Gate-Source Voltage	$V_{GS}$	$\pm 20$			V
Continuous Drain Current <sup>(Note 1)</sup>	$I_D$	$T_c = 25^\circ C$			A
		$T_c = 100^\circ C$			A
Pulsed Drain Current <sup>(Note 2)</sup>	$I_{DM}$	-64			A
Single Pulse Avalanche Energy <sup>(Note 3)</sup>	$E_{AS}$	51			mJ
Single Pulse Avalanche Current <sup>(Note 2)</sup>	$I_{AS}$	-32			A
Power Dissipation @ $T_c = 25^\circ C$	$P_D$	40	27	66	W
Operating Junction Temperature	$T_J$	-50 to +150			$^\circ C$
Storage Temperature Range	$T_{STG}$	-50 to +150			$^\circ C$

### Thermal Performance

Parameter	Symbol	Limit			Unit
		IPAK/DPAK	ITO-220	TO-220	
Thermal Resistance - Junction to Case	$R_{JC}$	3.1	4.7	1.9	°C/W
Thermal Resistance - Junction to Ambient	$R_{JA}$	62			°C/W

### Electrical Specifications ( $T_C = 25^\circ\text{C}$ unless otherwise noted)

Parameter	Conditions	Symbol	Min	Typ	Max	Unit
<b>Static</b>						
Drain-Source Breakdown Voltage	$V_{GS} = 0\text{V}, I_D = 250\mu\text{A}$	$BV_{DSS}$	-60	--	--	V
Drain-Source On-State Resistance	$V_{GS} = -10\text{V}, I_D = -8\text{A}$	$R_{DS(ON)}$	--	39	48	m
	$V_{GS} = -4.5\text{V}, I_D = -4\text{A}$		--	53	65	
Gate Threshold Voltage	$V_{DS} = V_{GS}, I_D = -250\mu\text{A}$	$V_{GS(TH)}$	-1.2	-1.6	-2.2	V
Zero Gate Voltage Drain Current	$V_{DS} = -60\text{V}, V_{GS} = 0\text{V}$	$I_{DSS}$	--	--	-1	$\mu\text{A}$
	$V_{DS} = -48\text{V}, T_C = 125^\circ\text{C}$		--	--	-10	
Gate Body Leakage	$V_{GS} = \pm 20\text{V}, V_{DS} = 0\text{V}$	$I_{GSS}$	--	--	$\pm 100$	nA
Forward Transconductance <sup>(Note 4)</sup>	$V_{DS} = -10\text{V}, I_D = -8\text{A}$	$g_{fs}$	--	10	--	S
<b>Dynamic</b>						
Total Gate Charge <sup>(Note 4,5)</sup>	$V_{DS} = -30\text{V}, I_D = -8\text{A},$ $V_{GS} = -10\text{V}$	$Q_g$	--	22.4	--	nC
Gate-Source Charge <sup>(Note 4,5)</sup>		$Q_{gs}$	--	4.1	--	
Gate-Drain Charge <sup>(Note 4,5)</sup>		$Q_{gd}$	--	5.2	--	
Input Capacitance	$V_{DS} = -30\text{V}, V_{GS} = 0\text{V},$ $f = 1.0\text{MHz}$	$C_{iss}$	--	1250	--	pF
Output Capacitance		$C_{oss}$	--	85	--	
Reverse Transfer Capacitance		$C_{rss}$	--	65	--	
<b>Switching</b>						
Turn-On Delay Time <sup>(Note 4,5)</sup>	$V_{DD} = -30\text{V}, I_D = -1\text{A},$ $R_{GEN} = 6$	$t_{d(on)}$	--	13	--	ns
Turn-On Rise Time <sup>(Note 4,5)</sup>		$t_r$	--	42.4	--	
Turn-Off Delay Time <sup>(Note 4,5)</sup>		$t_{d(off)}$	--	64.6	--	
Turn-Off Fall Time <sup>(Note 4,5)</sup>		$t_f$	--	16.4	--	
<b>Source-Drain Diode Ratings and Characteristic</b>						
Maximum Continuous Drain-Source Diode Forward Current	Integral reverse diode in the MOSFET	$I_S$	--	--	-16	A
Maximum Pulse Drain-Source Diode Forward Current		$I_{SM}$	--	--	-64	A
Diode-Source Forward Voltage	$V_{GS} = 0\text{V}, I_S = -1\text{A}$	$V_{SD}$	--	--	-1	V

#### Note:

- Limited by maximum junction temperature
- Pulse width limited by safe operating area
- $L = 3.68\text{mH}, I_{AS} = 8\text{A}, V_{DD} = 50\text{V}, R_G = 25 \Omega$ , Starting  $T_J = 25^\circ\text{C}$
- Pulse test: pulse width  $m300\mu\text{s}$ , duty cycle  $m2\%$
- Switching time is essentially independent of operating temperature



### Electrical Characteristics Curve

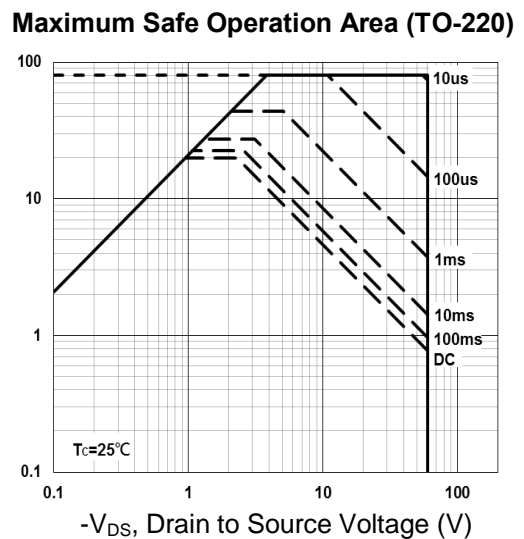
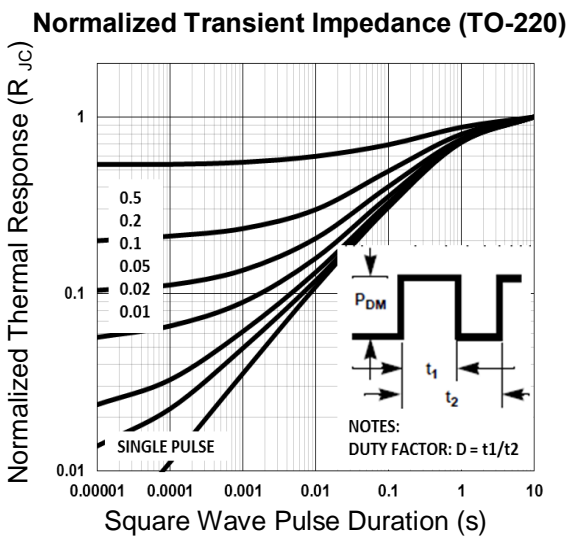
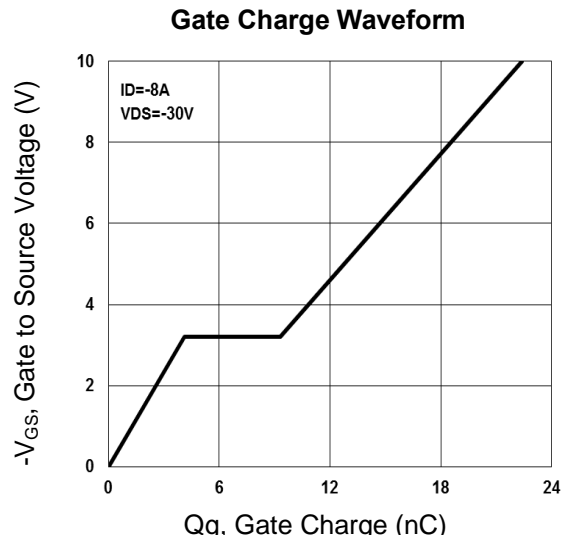
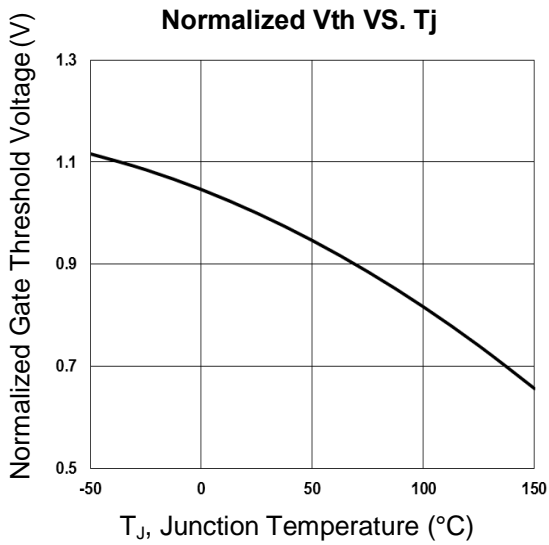
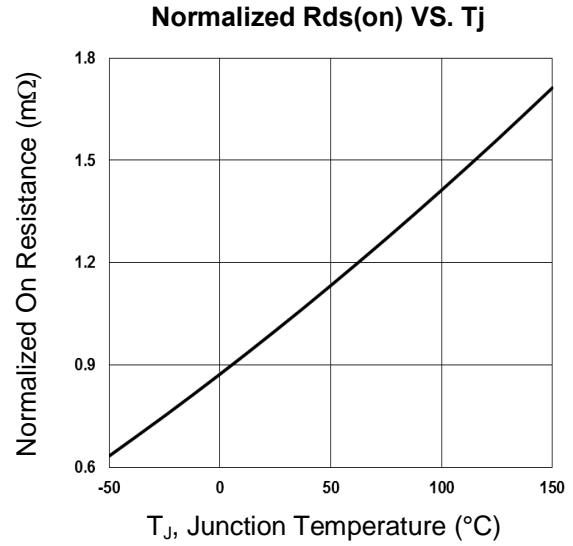
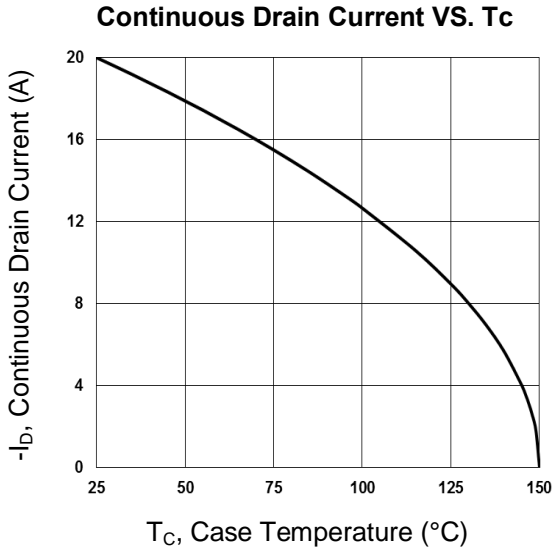



### Electrical Characteristics Curve

**Normalized Transient Impedance (ITO-220)**

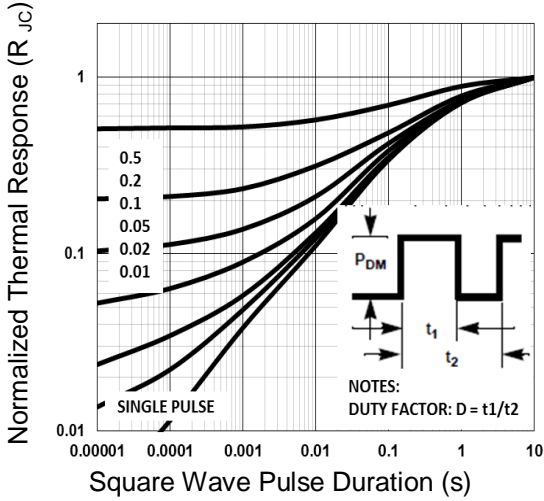

**Maximum Safe Operation Area (ITO-220)**

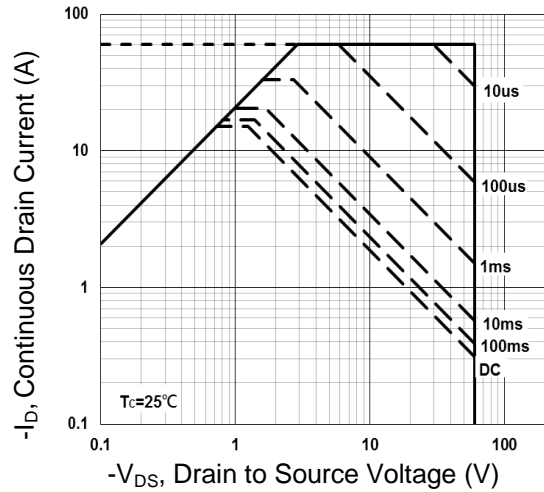

**Normalized Transient Impedance (TO-251S)**

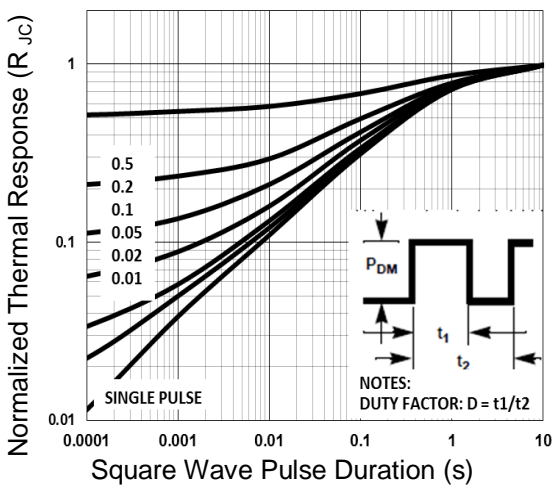

**Maximum Safe Operation Area (TO-251S)**

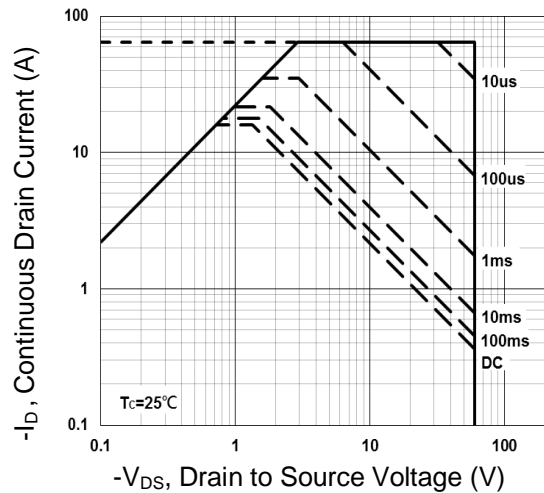

**Normalized Transient Impedance (TO-252)**

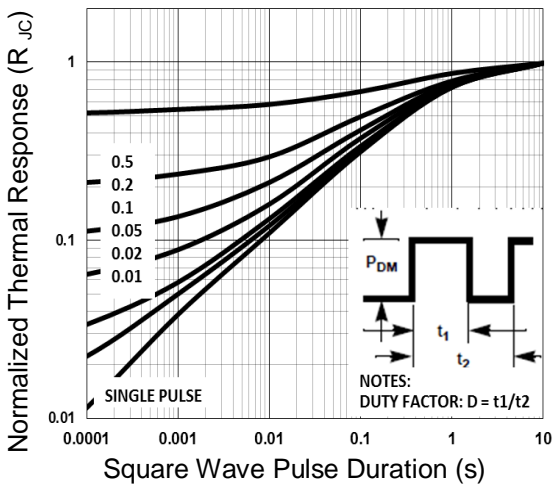

**Maximum Safe Operation Area (TO-252)**

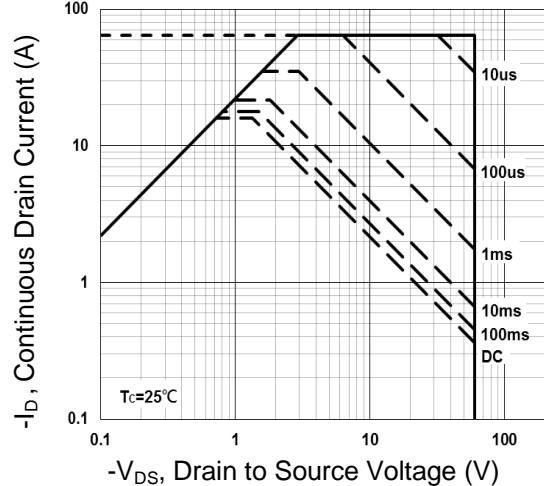



### TO-220 Mechanical Drawing

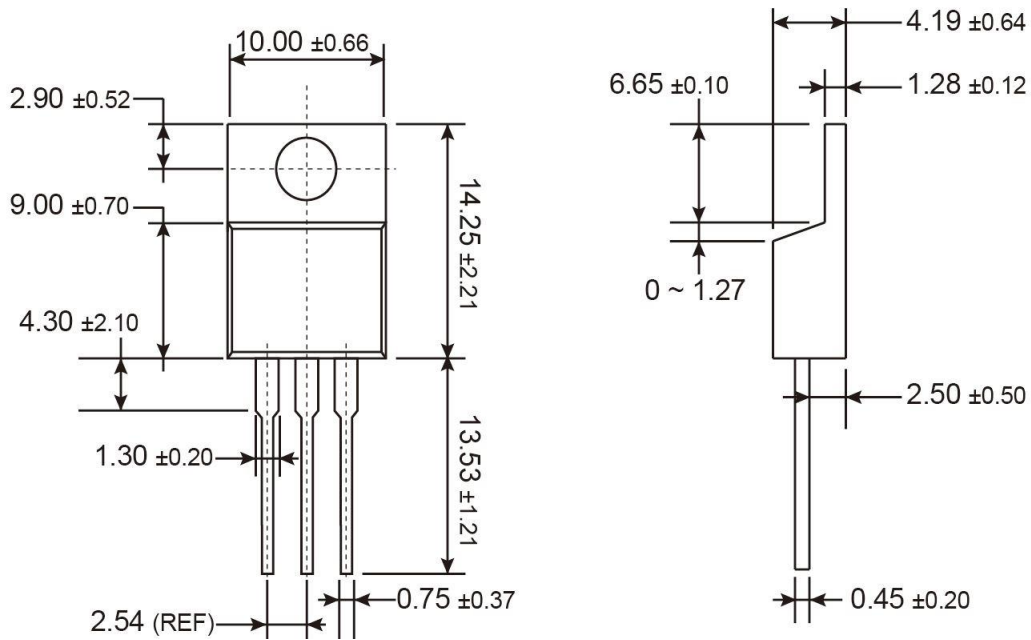

Unit: Millimeters

### Marking Diagram

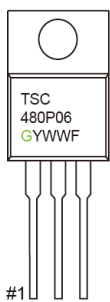

- G** = Halogen Free
- Y** = Year Code
- WW** = Week Code (01~52)
- F** = Factory Code



### ITO-220 Mechanical Drawing

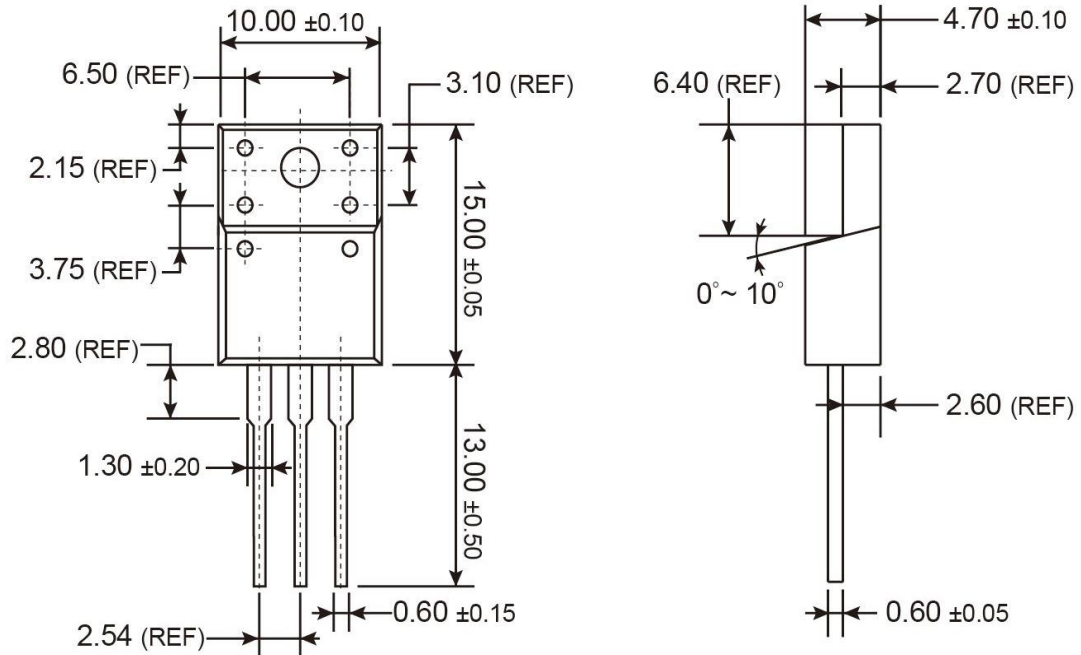

Unit: Millimeters

### Marking Diagram



- G** = Halogen Free
- Y** = Year Code
- WW** = Week Code (01~52)
- F** = Factory Code



### TO-251S Mechanical Drawing

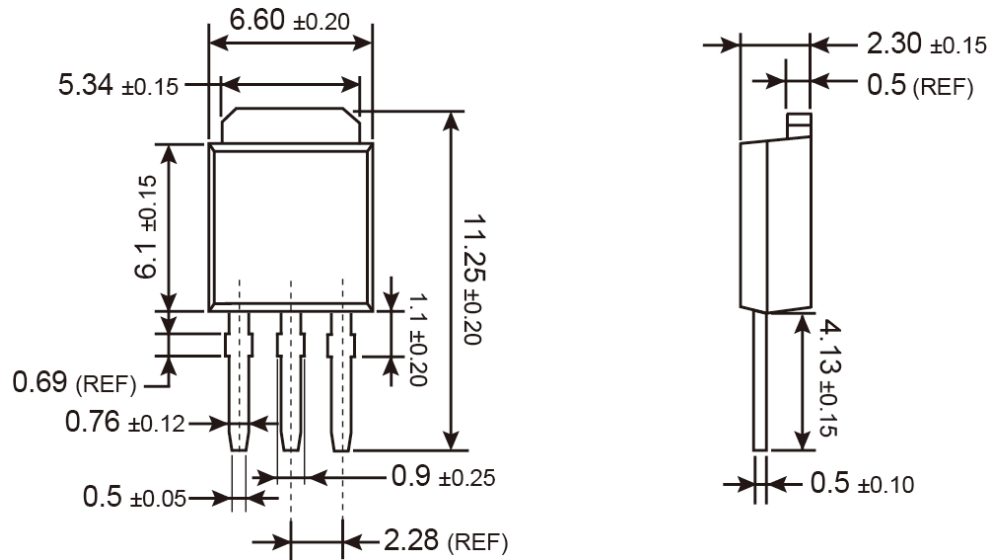

Unit: Millimeters

### Marking Diagram

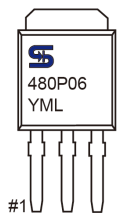

- Y** = Year Code
- M** = Month Code for Halogen Free Product  
(O=Jan, P=Feb, Q=Mar, R=Apr, S=May, T=Jun, U=Jul, V=Aug, W=Sep, X=Oct, Y=Nov, Z=Dec)
- L** = Lot Code



### TO-252 Mechanical Drawing

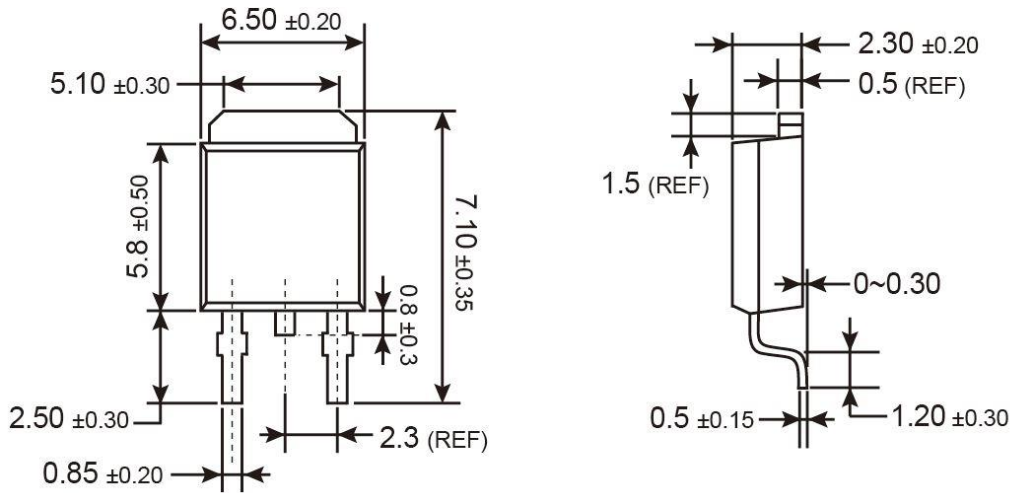

Unit: Millimeters

### Marking Diagram

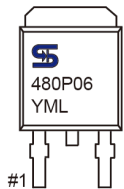

- Y** = Year Code
- M** = Month Code for Halogen Free Product  
(**O**=Jan, **P**=Feb, **Q**=Mar, **R**=Apr, **S**=May, **T**=Jun, **U**=Jul, **V**=Aug, **W**=Sep, **X**=Oct, **Y**=Nov, **Z**=Dec)
- L** = Lot Code



### Notice

Specifications of the products displayed herein are subject to change without notice. TSC or anyone on its behalf, assumes no responsibility or liability for any errors or inaccuracies.

Information contained herein is intended to provide a product description only. No license, express or implied, to any intellectual property rights is granted by this document. Except as provided in TSC's terms and conditions of sale for such products, TSC assumes no liability whatsoever, and disclaims any express or implied warranty, relating to sale and/or use of TSC products including liability or warranties relating to fitness for a particular purpose, merchantability, or infringement of any patent, copyright, or other intellectual property right.

The products shown herein are not designed for use in medical, life-saving, or life-sustaining applications. Customers using or selling these products for use in such applications do so at their own risk and agree to fully indemnify TSC for any damages resulting from such improper use or sale.