



AC Input 4-Pin Mini-Flat Phototransistor Optocoupler

Features

- High isolation 3750 VRMS
- CTR flexibility available see order information
- AC input with transistor output
- Temperature range - 55 °C to 110 °C
- Regulatory Approvals
 - UL - UL1577 (E364000)
 - VDE - EN60747-5-5(VDE0884-5)
 - CQC – GB4943.1, GB8898
 - IEC60065, IEC60950

Description

These series of AC input optocoupler consists of a photo transistor optically coupled to two gallium arsenide Infrared-emitting diodes in a 4-lead Mini-Flat package.

Applications

- Switch mode power supplies
- Computer peripheral interface
- Microprocessor system interface

Package Outline

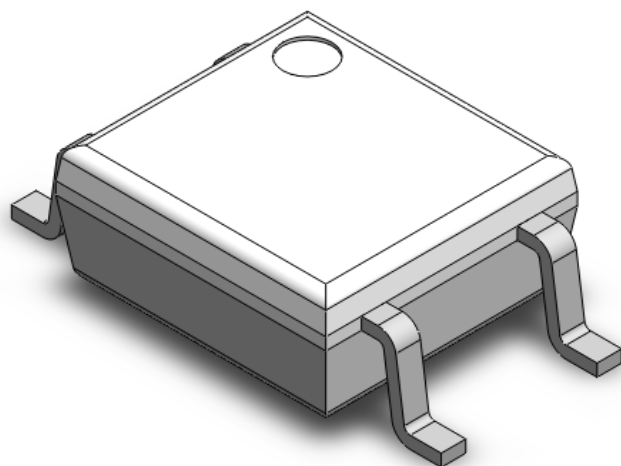

Schematic

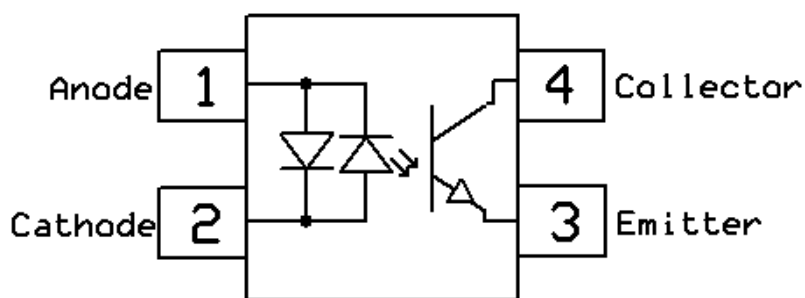

**AC Input 4-Pin Mini-Flat Phototransistor Optocoupler****Absolute Maximum Rating at 25°C**

Symbol	Parameters	Ratings	Units	Notes
V _{ISO}	Isolation voltage	3750	V _{RMS}	
T _{OPR}	Operating temperature	-55 ~ +110	°C	
T _{STG}	Storage temperature	-55 ~ +150	°C	
T _{SOL}	Soldering temperature	260	°C	
P _{TOT}	Total power dissipation	200	mW	
Emitter				
I _F	Forward current	±50	mA	
I _{F(TRANS)}	Peak transient current (≤1μs P.W,300pps)	1	A	
P _D	Power dissipation	70	mW	
Detector				
P _C	Power dissipation	150	mW	
B _{VCEO}	Collector-Emitter Breakdown Voltage	80	V	
B _{VECO}	Emitter-Collector Breakdown Voltage	7	V	
I _C	Collector Current	50	mA	



AC Input 4-Pin Mini-Flat Phototransistor Optocoupler

Electrical Characteristics $T_A = 25^\circ\text{C}$ (unless otherwise specified)

Emitter Characteristics

Symbol	Parameters	Test Conditions	Min	Typ	Max	Units	Notes
V_F	Forward voltage	$I_F=10\text{mA}$		1.24	1.4	V	
C_{IN}	Input Capacitance	$f=1\text{kHz}$	-	45	-	pF	

Detector Characteristics

Symbol	Parameters	Test Conditions	Min	Typ	Max	Units	Notes
$B_{V_{CEO}}$	Collector-Emitter Breakdown	$I_C=100\mu\text{A}$	80	-	-	V	
$B_{V_{ECO}}$	Emitter-Collector Breakdown	$I_E=100\mu\text{A}$	7	-	-	V	
I_{CEO}	Collector-Emitter Dark Current	$V_{CE}=20\text{V}, I_F=0\text{mA}$	-	-	100	nA	

Transfer Characteristics

Symbol	Parameters	Test Conditions	Min	Typ	Max	Units	Notes
CTR	Current Transfer Ratio	$I_F=\pm 1\text{mA}, V_{CE}=5\text{V}$	20	-	300	%	
			50	-	150		
	CTR Symmetry	$I_F=\pm 1\text{mA}, V_{CE}=5\text{V}$	0.7	-	1.3		
$V_{CE(SAT)}$	Collector-Emitter Saturation Voltage	$I_F=\pm 20\text{mA}, I_C=1\text{mA}$	-	0.1	0.2	V	
R_{IO}	Isolation Resistance	$V_{IO}=500\text{V}_{DC}$	5×10^{10}	-	-		
C_{IO}	Isolation Capacitance	$f=1\text{MHz}$	-	0.6	1.0	pF	

Switching Characteristics

Symbol	Parameters	Test Conditions	Min	Typ	Max	Units	Notes
t_r	Rise Time	$I_C=2\text{mA}, V_{CE}=2\text{V}, R_L=100$	-	6	18	μs	
t_f	Fall Time		-	8	18		



Typical Characteristic Curves

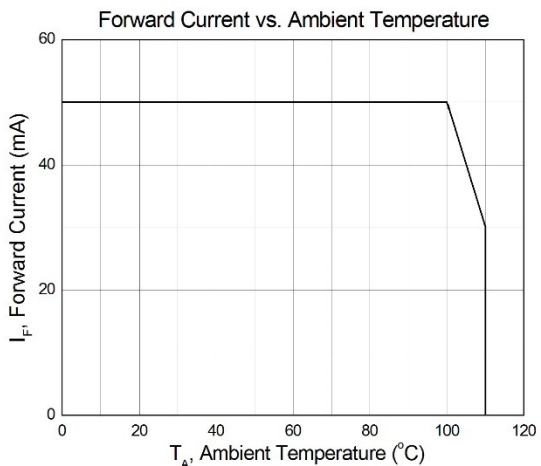

Figure 1

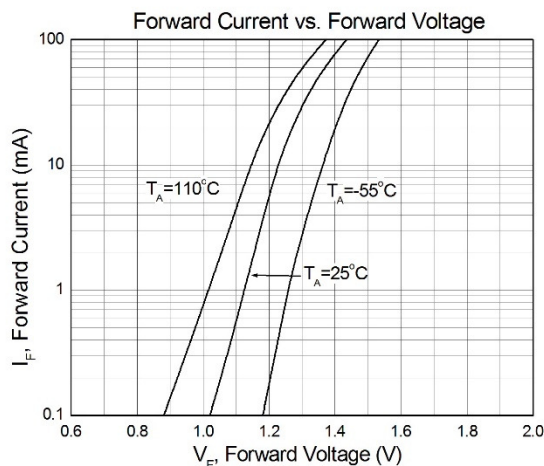

Figure 2

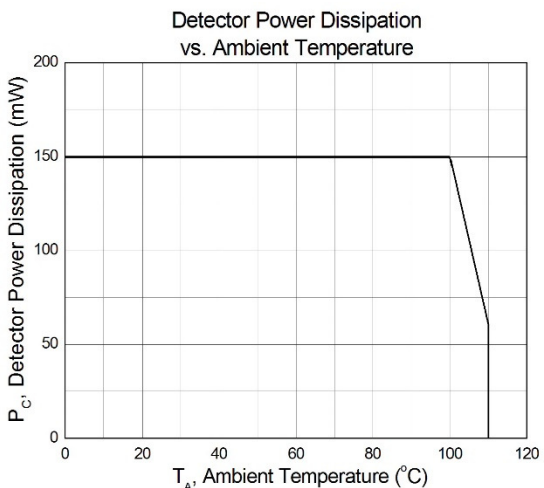

Figure 3

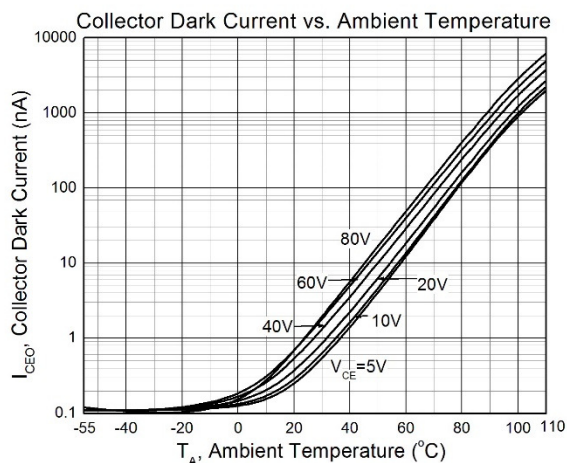

Figure 4

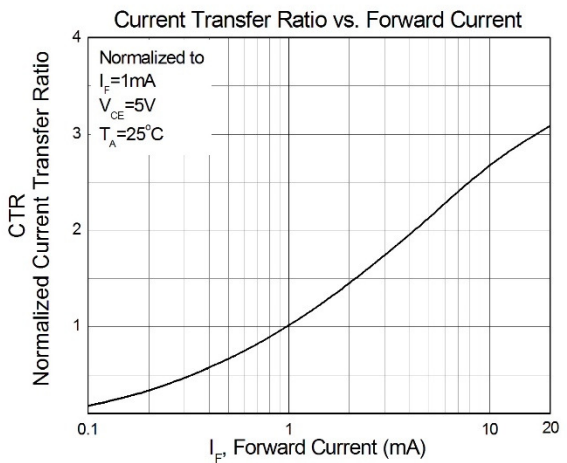

Figure 5

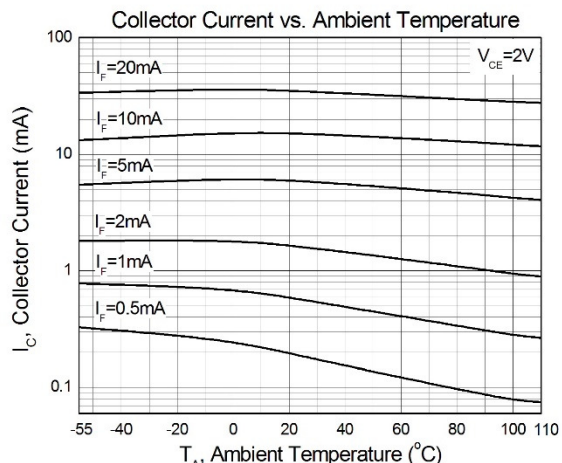

Figure 6



AC Input 4-Pin Mini-Flat Phototransistor Optocoupler

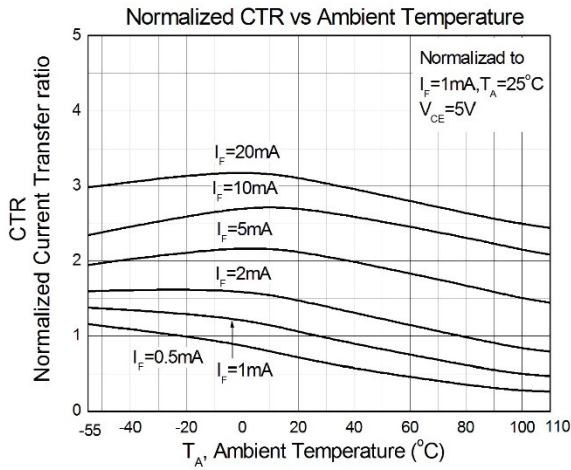

Figure 7

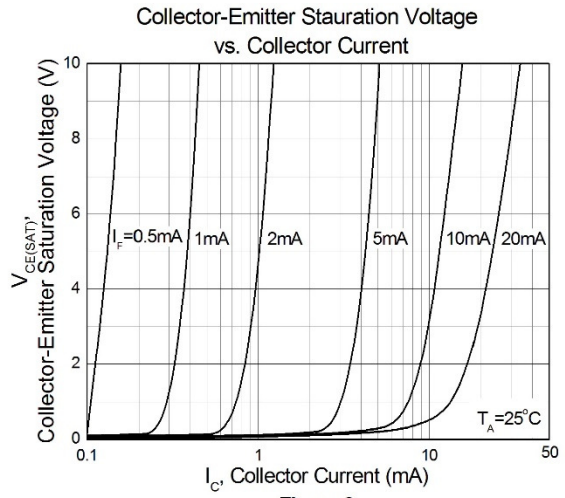

Figure 8

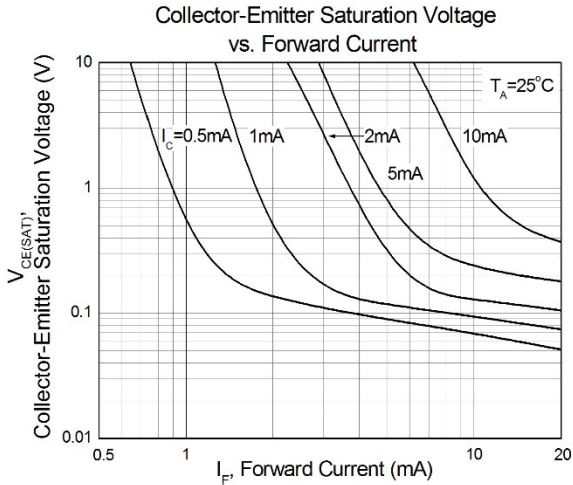

Figure 9

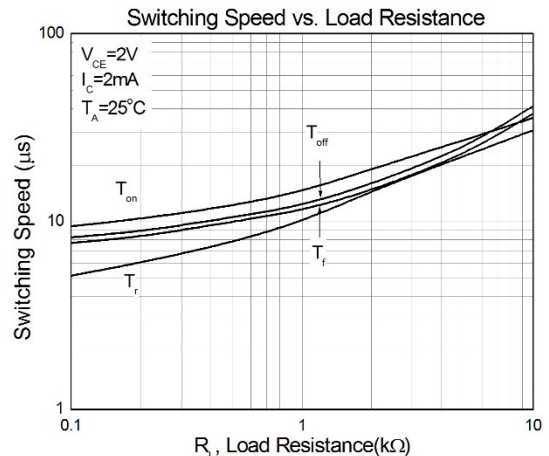

Figure 10

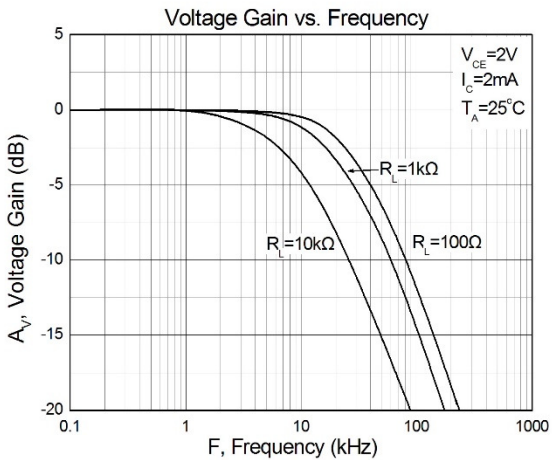

Figure 11

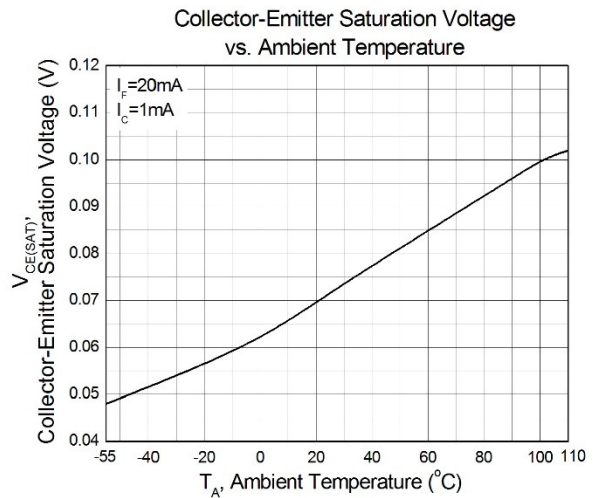
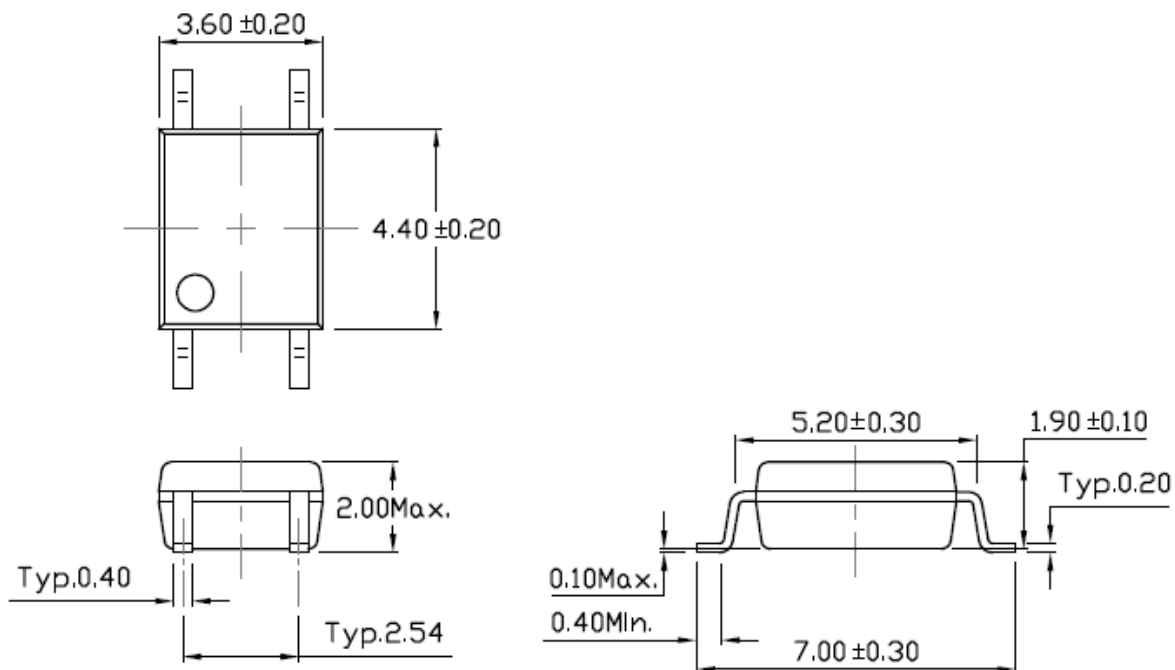

Figure 12



AC Input 4-Pin Mini-Flat Phototransistor Optocoupler

Package Dimension *Dimensions in mm unless otherwise stated*



Recommended Solder Mask *Dimensions in mm unless otherwise stated*

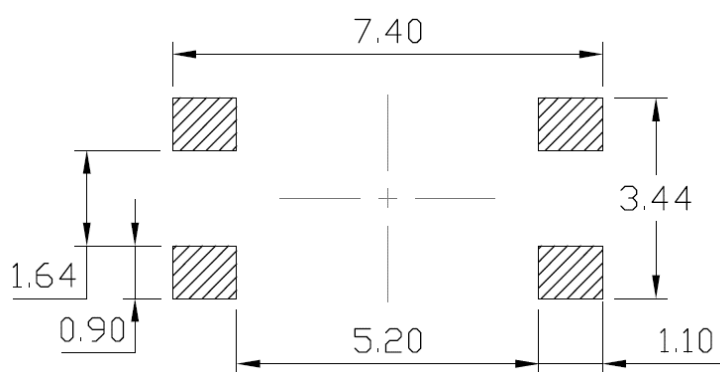

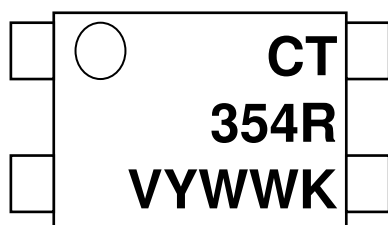

Marking Information

**Note:**

CT : Denotes "CT Micro"
354 : Product Number
R : CTR Rank
V : VDE Option
Y : Fiscal Year
WW : Work Week
K : Manufacturing Code

Ordering Information

CT354X(V)(Z)

X = Part No. (X=A or None)

V = VDE option (V or None)

Z = Tape and reel option (T1 or T2)

Option	Description	Quantity
T1	Surface Mount Lead Forming – With Option 1 Taping	3000 Units/Reel
T2	Surface Mount Lead Forming – With Option 2 Taping	3000 Units/Reel



AC Input 4-Pin Mini-Flat Phototransistor Optocoupler

Carrier Tape Specifications *Dimensions in mm unless otherwise stated*

Option (T1)

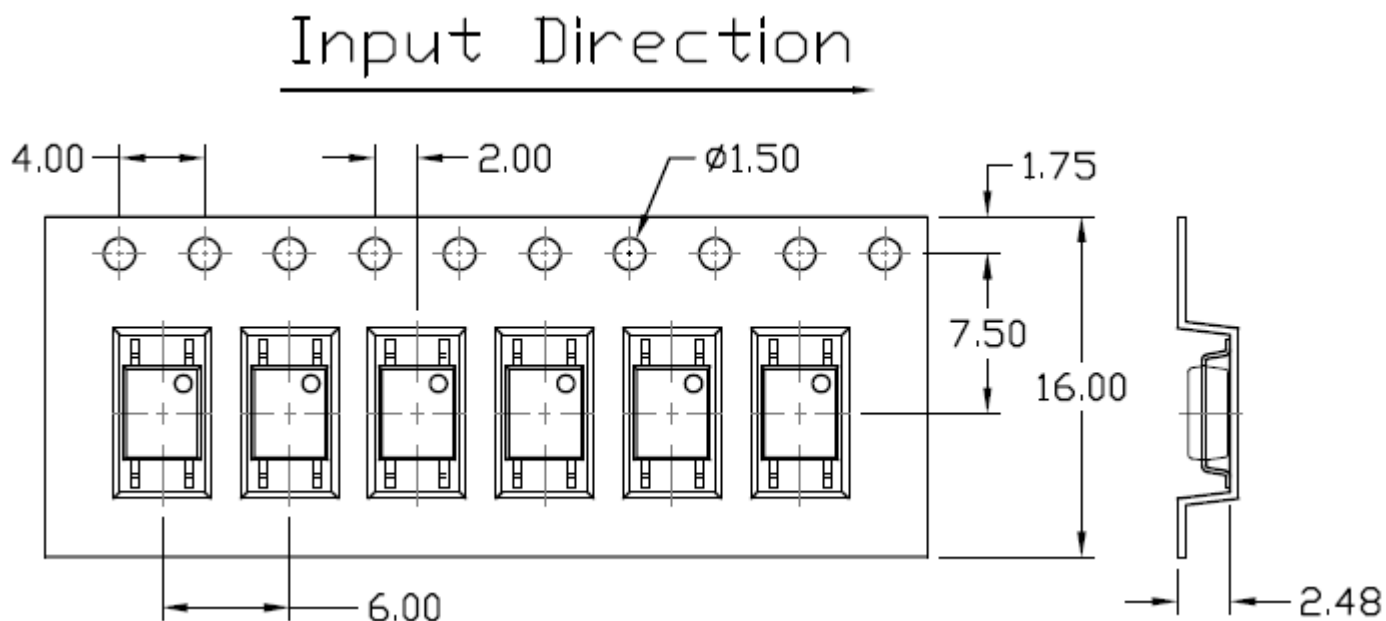

Option (T1)

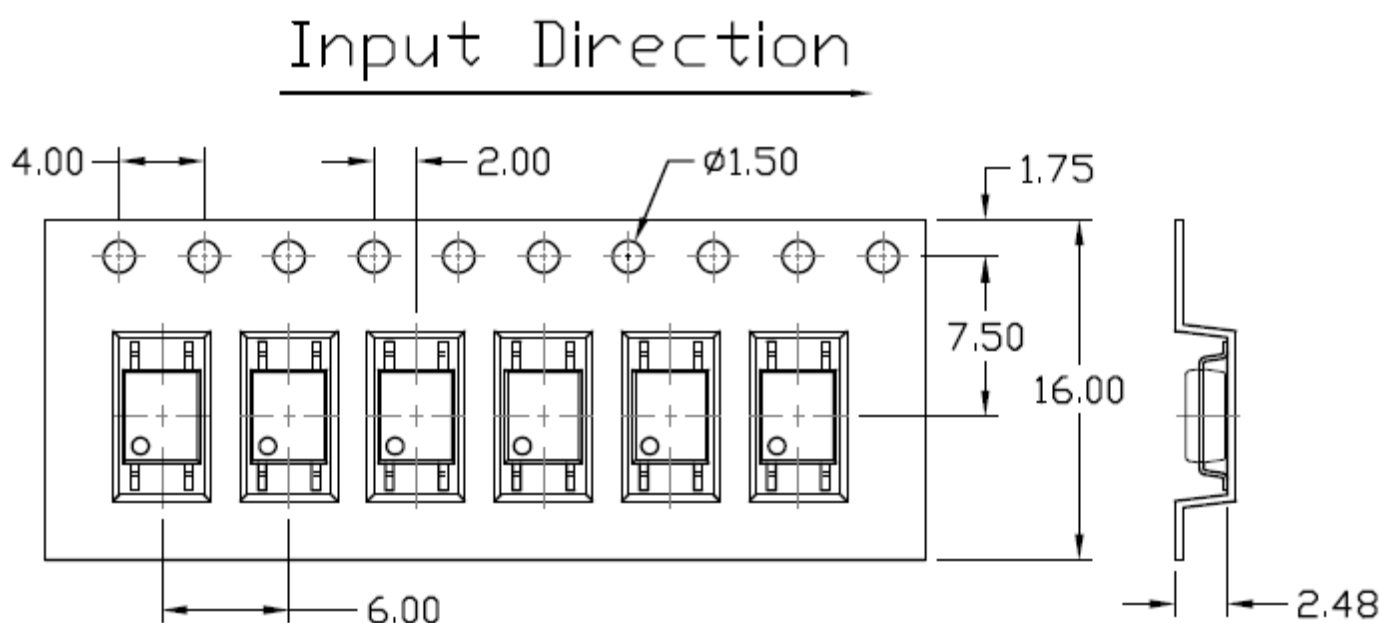



AC Input 4-Pin Mini-Flat Phototransistor Optocoupler

Reflow Profile

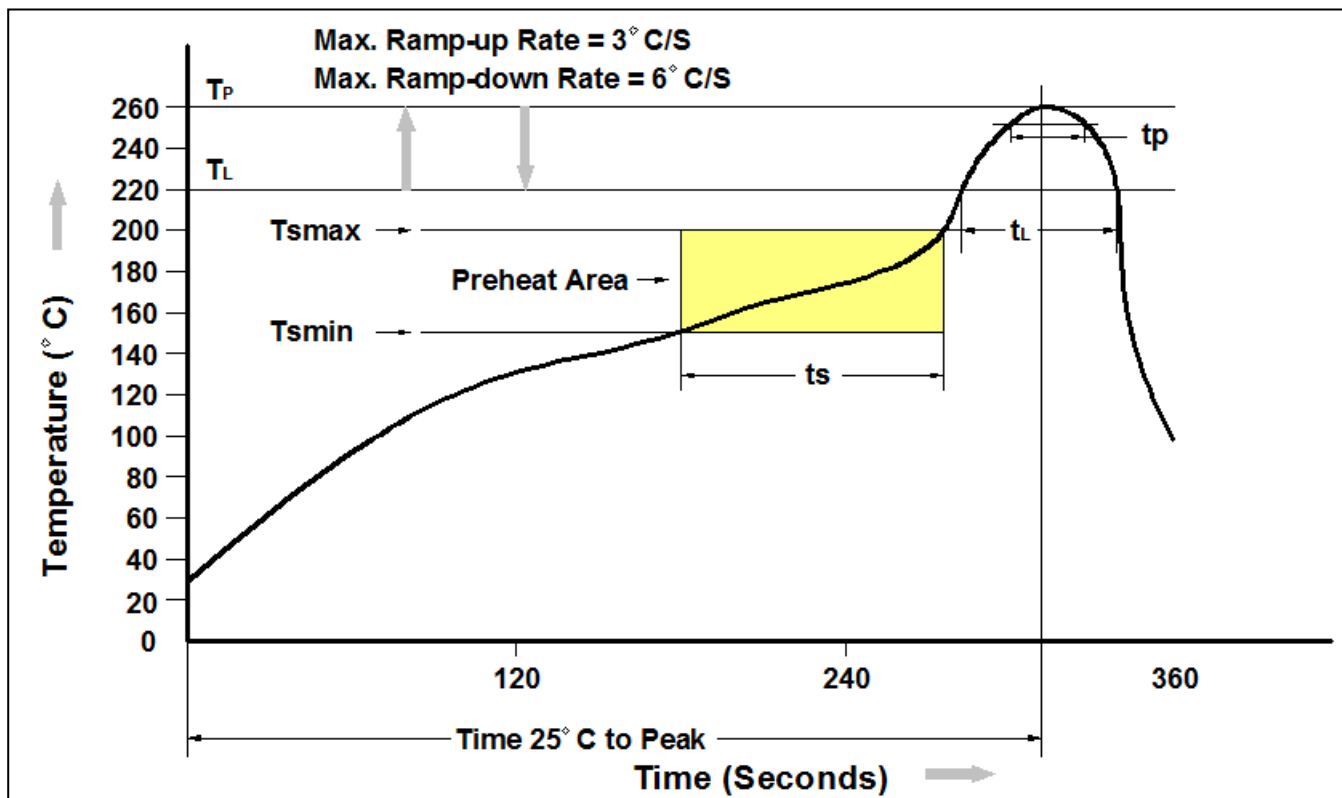

Profile Feature	Pb-Free Assembly Profile
Temperature Min. (T_{smin})	150 °C
Temperature Max. (T_{smax})	200 °C
Time (t_s) from (T_{smin} to T_{smax})	60-120 seconds
Ramp-up Rate (t_L to t_P)	3°C/second max.
Liquidous Temperature (T_L)	217 °C
Time (t_L) Maintained Above (T_L)	60 – 150 seconds
Peak Body Package Temperature	260 °C +0 °C / -5 °C
Time (t_P) within 5 °C of 260 °C	30 seconds
Ramp-down Rate (T_P to T_L)	6°C/second max
Time 25 °C to Peak Temperature	8 minutes max.



AC Input 4-Pin Mini-Flat Phototransistor Optocoupler

DISCLAIMER

CT MICRO RESERVES THE RIGHT TO MAKE CHANGES WITHOUT FURTHER NOTICE TO ANY PRODUCTS HEREIN TO IMPROVE RELIABILITY, FUNCTION OR DESIGN. CT MICRO DOES NOT ASSUME ANY LIABILITY ARISING OUT OF THE APPLICATION OR USE OF ANY PRODUCT OR CIRCUIT DESCRIBED HEREIN; NEITHER DOES IT CONVEY ANY LICENSE UNDER ITS PATENT RIGHTS, NOR THE RIGHTS OF OTHERS.

DISCOLORATION MIGHT OCCUR ON THE PACKAGE SURFACE AFTER SOLDERING, REFLOW OR LONG TERM USE. THIS DOES NOT IMPACT THE PRODUCT PERFORMANCE NOR THE PRODUCT RELIABILITY.

CT MICRO ARE NOT AUTHORIZED FOR USE AS CRITICAL COMPONENTS IN LIFE SUPPORT DEVICES OR SYSTEMS WITHOUT EXPRESS WRITTEN APPROVAL OF CT MICRO INTERNATIONAL CORPORATION.

- 1. Life support devices or systems are devices or systems which, (a) are intended for surgical implant into the body, or (b) support or sustain life, or (c) whose failure to perform when properly used in accordance with instruction for use provided in the labelling, can be reasonably expected to result in significant injury to the user.*
- 2. A critical component is any component of a life support device or system whose failure to perform can be reasonably expected to cause the failure of the life support device or system, or to affect its safety or effectiveness.*