



FEATURES

- Application for Extreme Low Output Voltage
- Guaranteed 300mA Output Current
- Very Low Quiescent Current at about 40uA
- $\pm 2\%$ Output Voltage Accuracy
- Needs Only 1 μ F Capacitor for Stability
- Thermal Shutdown / Current Limited Protection
- Adjusted Mode with 0.8V Reference Voltage
- Low-ESR Ceramic Capacitor for Output Stability
- Tiny SOT-23-5L, SOT-23-5LR & SC-70-5L Package Type
- RoHS Compliant
- High PSRR

DESCRIPTION

The APE8867 series are low dropout, positive linear regulators with very low quiescent current. The APE8867 can supply 300mA output current with a low dropout voltage & very low output voltage.

The APE8867 regulator is able to operate with output capacitors as small as 1 μ F to 10 μ F for stability. Other than the current limit protection APE8867 also offers on chip thermal shutdown feature providing protection against overload or any condition when the ambient temperature exceeds the junction temperature.

The APE8867 series are available in low-profile, space-saving SOT-23-5L, SOT-23-5LR & SC-70-5L packages.

APPLICATIONS

- DVD/CD-ROMs, CD/RWs
- Wireless Devices
- LCD Modules
- Battery Power Systems
- Card Readers
- XDSL Routers

TYPICAL APPLICATION

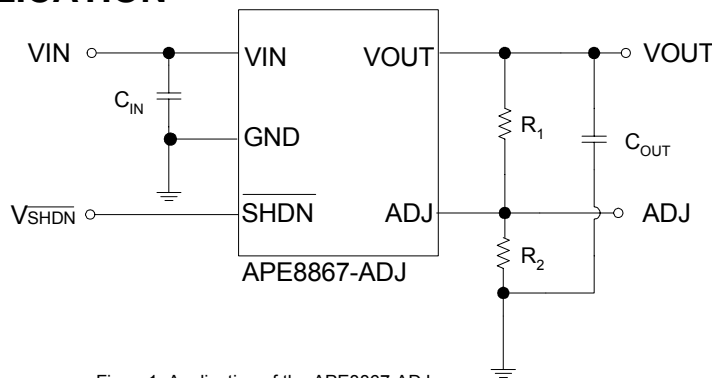

Figure1. Application of the APE8867-ADJ

Note : R₁,R₂ for adjusted mode only

Note : To prevent oscillation, it is recommended to use minimum 1uF X7R or X5R dielectric capacitors if ceramics are used as input / output capacitors.

ORDERING / PACKAGE INFORMATION

APE8867X

Package Type
Y5 : SOT-23-5L
Y5R : SOT-23-5LR
U5 : SC-70-5L

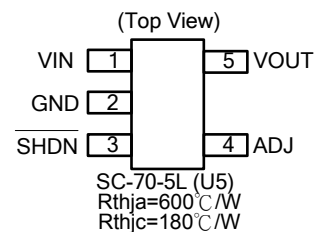
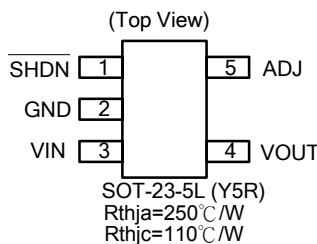
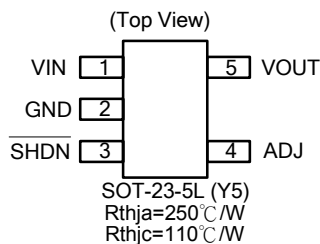



ABSOLUTE MAXIMUM RATINGS

Input Voltage (VIN) -----	6V
Power Dissipation (SOT-23-5L) -----	0.4W
(SC-70-5L) -----	0.16W
Storage Temperature Range -----	-65°C To 150°C
Maximum Junction Temperature -----	150°C

RECOMMENDED OPERATING CONDITIONS

Input Voltage (VIN) -----	2.8 to 5.5V
Operating Junction Temperature Range (T _J) -----	-40 to 125°C
Ambient Temperature (T _A) -----	-40 to 85°C

ELECTRICAL SPECIFICATIONS

(V_{IN}=V_{OUT}+1V or V_{IN}=2.8V whichever is greater, C_{IN}=1uF, C_{OUT}=1uF, T_A=25°C, unless otherwise specified)

Parameter	SYM	TEST CONDITION	MIN	TYP	MAX	UNITS	
Output Voltage Accuracy	ΔV _{OUT}	I _O = 1mA	-2	-	2	%	
Current Limit	I _{LIMIT}	R _{Load} =1Ω	300	-	-	mA	
Quiescent Current	I _Q	I _O = 0mA	-	40	55	μA	
Dropout Voltage (Note 1)	V _{DROP}	I _O =300mA	0.8V ≤ V _{OUT} ≤ 2.0V	-	1000	-	mV
			2.0V < V _{OUT} ≤ 2.8V	-	350	-	
			2.8V < V _{OUT} ≤ 3.3V	-	250	-	
Line Regulation	ΔV _{LINE}	I _O =1mA, V _{IN} =V _{OUT} +1V to 5V	-	1	5	mV	
Load Regulation (Note 2)	ΔV _{LOAD}	I _O =1mA to 300mA	-	6	20	mV	
Ripple Rejection	PSRR	I _O =1mA, C _{OUT} =1uF, f _{RIPPLE} = 100HZ	-	68	-	dB	
		I _O =1mA, C _{OUT} =1uF, f _{RIPPLE} = 10KHZ	-	48	-		
Temperature Coefficient	TC	I _{OUT} = 1mA, V _{IN} = 5V	-	50	-	ppm/ °C	
Thermal Shutdown Temperature	TSD		-	160	-	°C	
Thermal Shutdown Hysteresis	ΔTSD		-	25	-	°C	
Shutdown Pin Current	I _{SHDN}		-	-	0.1	μA	
Shutdown Pin Voltage (ON)	V _{SHDN(ON)}		1.4	-	-	V	
Shutdown Pin Voltage (OFF)	V _{SHDN(OFF)}		-	-	0.4	V	

Note 1 : The dropout voltage is defined as V_{IN}-V_{OUT}, which is measured when V_{OUT} drop about 100mV.

Note 2 : Regulation is measured at a constant junction temperature by using 30ms current pulse and load regulation in the load range from 0mA to 300mA.



PIN DESCRIPTIONS

PIN SYMBOL	PIN DESCRIPTION
VIN	Power is supplied to this device from this pin which is required an input filter capacitor. In general, the input capacitor in the range of 1μF to 10μF is sufficient.
VOUT	The output supplies power to loads. The output capacitor is required to prevent output voltage unstable. The APE8867 is stable with an output capacitor 1μF to 10μF. The larger output capacitor will be required for application with large transit load to limit peak voltage transients, besides could reduce output noise, improve stability, PSRR.
GND	Common ground pin
ADJ	For Adjusted mode, Apply R ₁ /R ₂ resistor divider with V _{OUT} to GND
NC	No connected
SHDN	Chip Enable (Active High)

BLOCK DIAGRAM

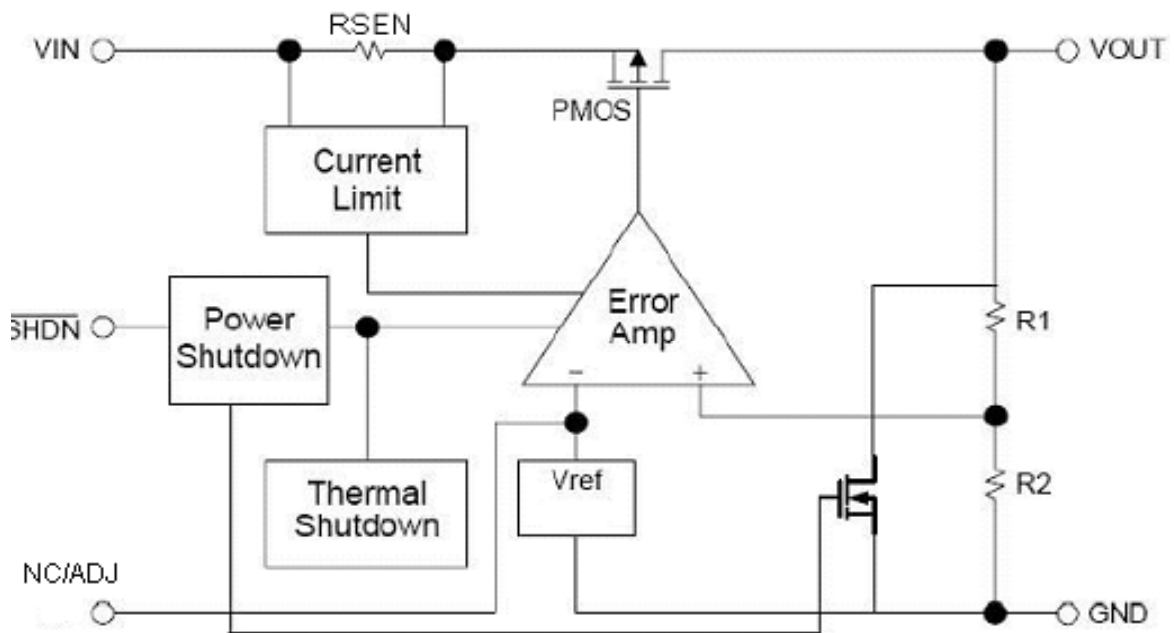

Figure 2. Block Diagram of APE8867

$$V_{OUT} = 0.8 \times (1 + R_1/R_2)$$



APPLICATION INFORMATION

The APE8867 series are low dropout linear regulators that could provide 300mA output current at dropout voltage about 300mV. Besides, current limit and on chip thermal shutdown features provide protection against any combination of overload or ambient temperature that could exceed junction temperature.

Output & Input Capacitor

The APE8867 regulator is designed to be stable with a wide range of output capacitors. The ESR of the output capacitor affects stability. Larger value of the output capacitor decreases the peak deviations and provides to improve transition response for larger current changes.

The capacitor types (aluminum, ceramic, and tantalum) have different characterizations such as temperature and voltage coefficients. All ceramic capacitors are manufactured with a variety of dielectrics, each with different behavior across temperature and applications. Common dielectrics used are X5R, X7R and Y5V. It is recommended to use 1uF to 10uF X5R or X7R dielectric ceramic capacitors with 30 mohm to 50 mohm ESR range between device outputs to ground for transient stability. The APE8867 is designed to be stable with low ESR ceramic capacitors and higher values of capacitors and ESR could improve output stability.

So the ESR of output capacitor is very important because it generates a zero to provide phase lead for loop stability. There are no requirements for the ESR on the input capacitor, but its voltage and temperature coefficient have to be considered for device application environment.

Protection Features

In order to prevent overloading or thermal condition from damaging the device, APE8867 regulator has internal thermal and current limiting functions designed to protect the device. It will rapidly shut off PMOS pass element during overloading or over temperature condition.

Thermal Consideration

The power handling capability of the device will be limited by maximum operation junction temperature (125°C). The power dissipated by the device will be estimated by $P_D = I_{OUT} \times (V_{IN} - V_{OUT})$. The power dissipation should be lower than the maximum power dissipation listed in "Absolute Maximum Ratings" section.



TYPICAL PERFORMANCE CHARACTERISTICS

I_{Limit} vs. Temperature

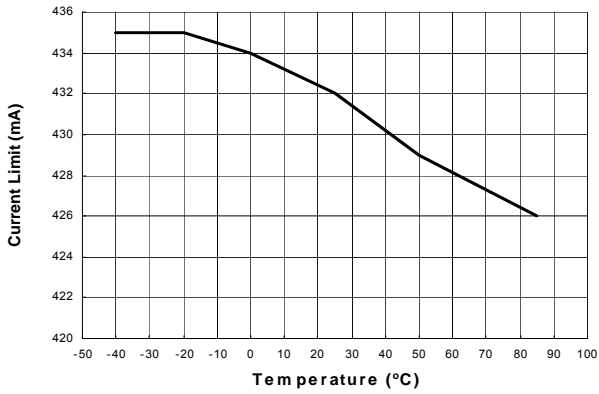

V_{IN} vs. I_{Limit}

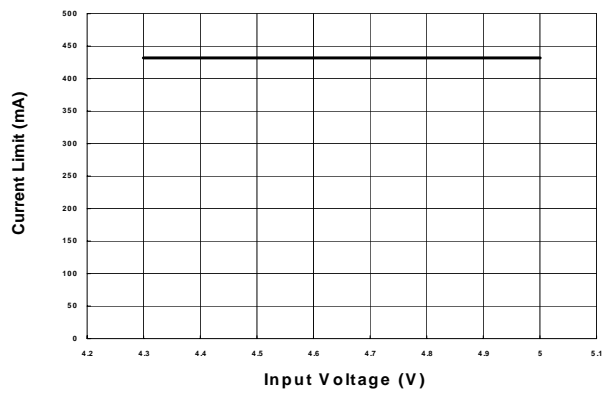

Dropout vs. Temperature

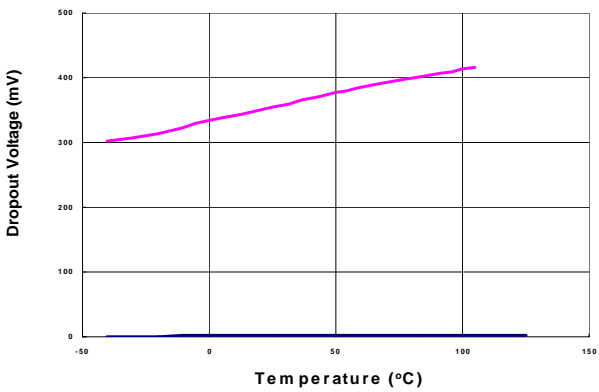

Dropout Voltage

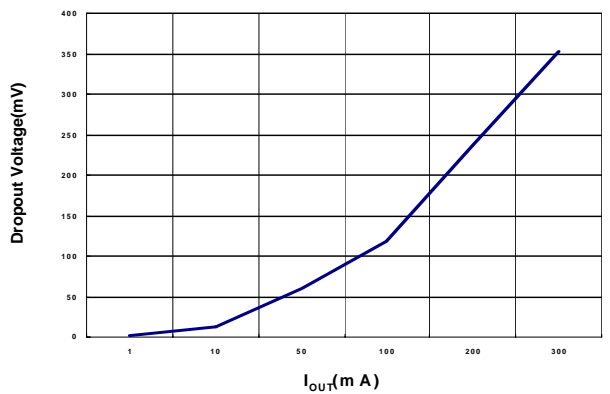

I_Q vs. Temperature

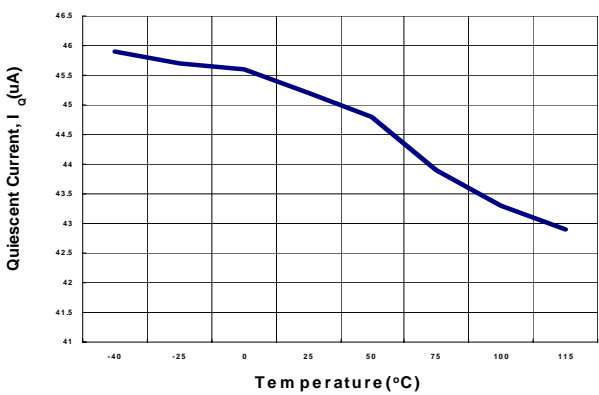

I_Q vs. V_{IN}

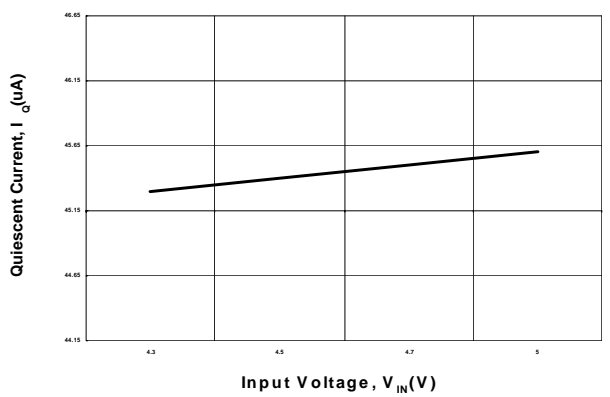



TYPICAL PERFORMANCE CHARACTERISTICS

V_{OUT} vs. Temperature

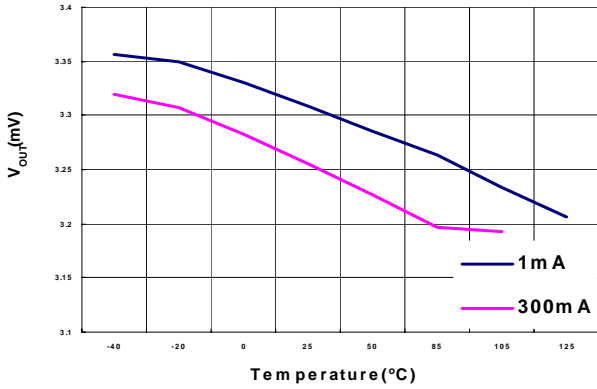

Load Regulation

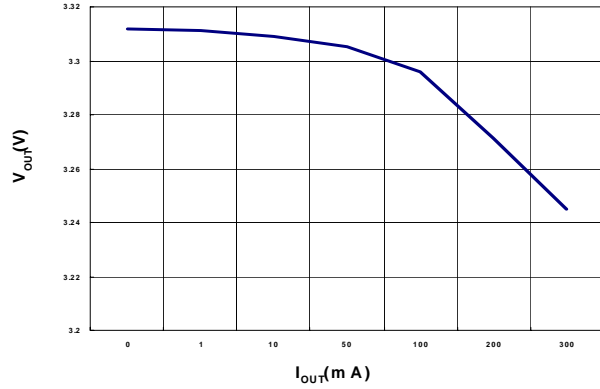

Line Regulation

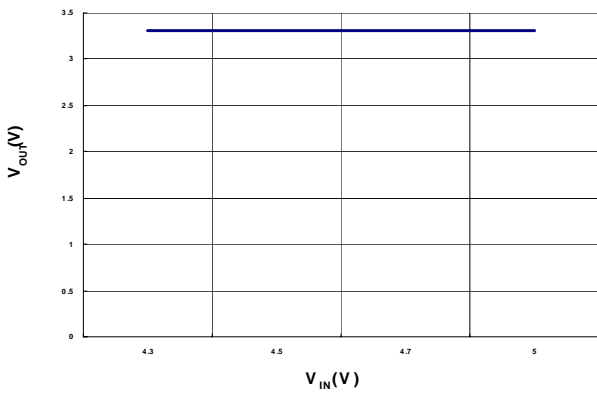

Load Transient

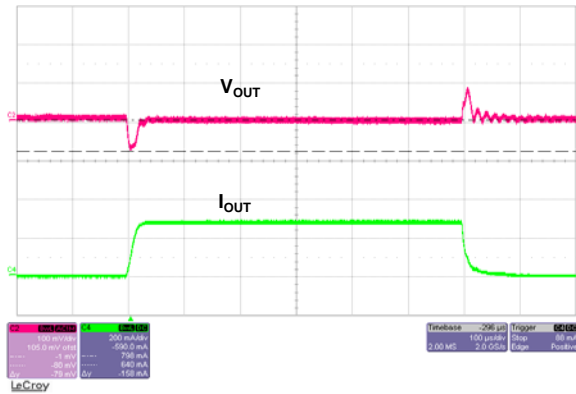

V_{IN}=4.3V, I_{OUT}=10mA~300mA, T_A=25°C

PSRR (I_{OUT}=1mA)

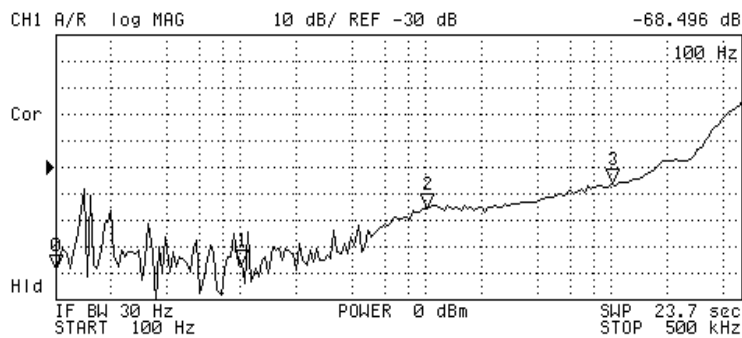

SELECT LETTER
SPACE
BACK SPACE
ERASE TITLE

N	SWP PARAM	VAL
0	100 Hz	-68.496 dB
1	1.001695 kHz	-66.918 dB
2	10.034367 kHz	-45.766 dB
3	100.077877 kHz	-36.457 dB

DONE



TYPICAL PERFORMANCE CHARACTERISTICS

Power On Test

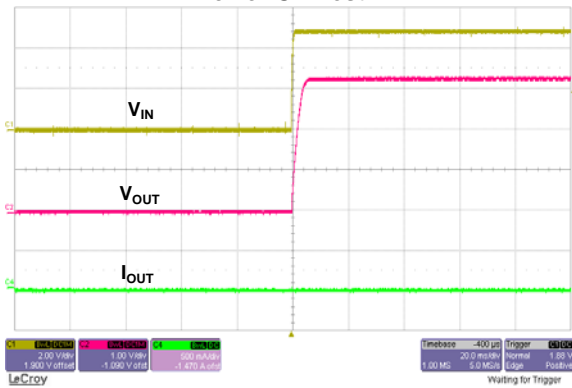

$V_{IN}=4.3V$, $V_{OUT}=3.3V$, $I_{OUT}=0mA$,

Power Off Test

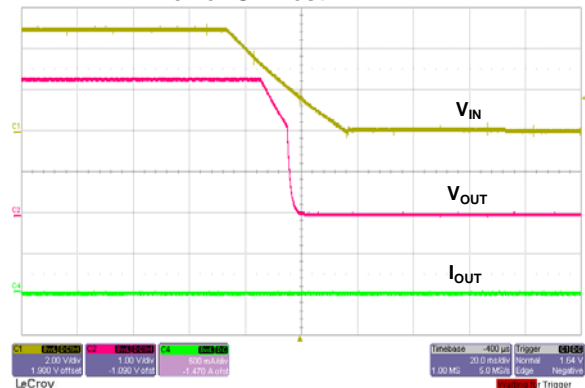

Power On Test

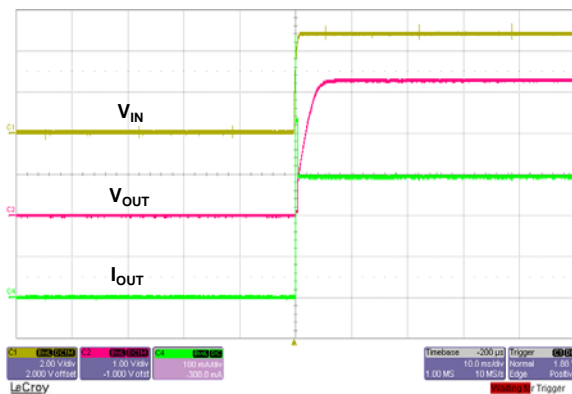

$V_{IN}=4.3V$, $V_{OUT}=3.3V$, $I_{OUT}=300mA$,

Power Off Test

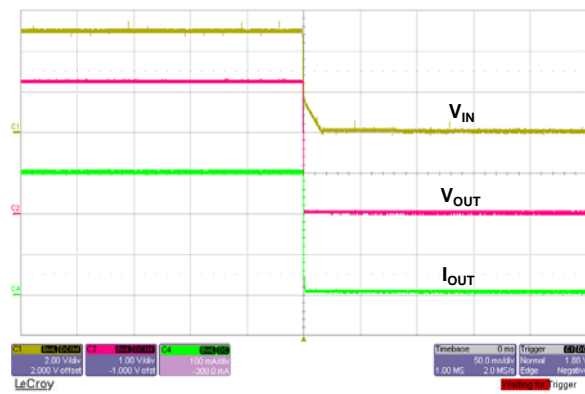

Enable On Test

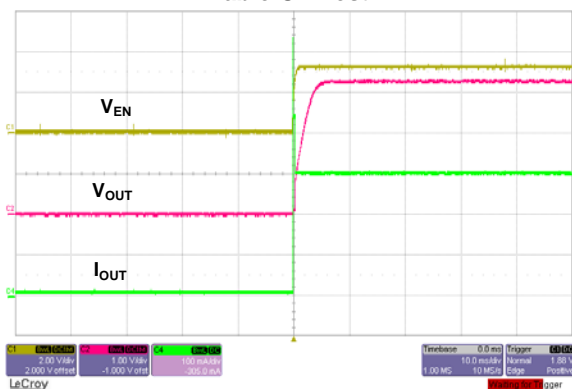

$V_{IN}=4.3V$, $V_{OUT}=3.3V$, $I_{OUT}=300mA$,

Enable Off Test

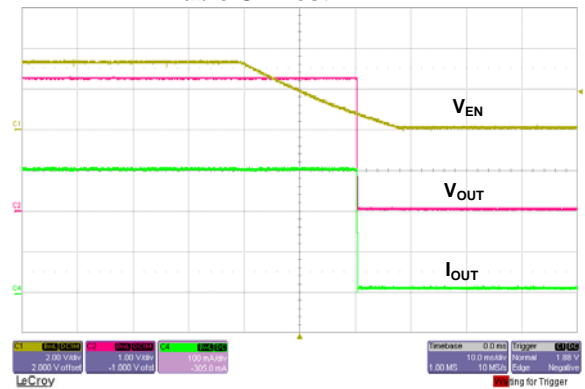



MARKING INFORMATION

SOT-23-5L

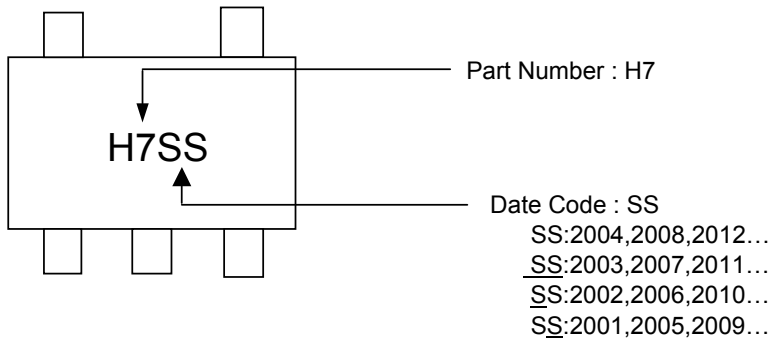

SC-70-5L

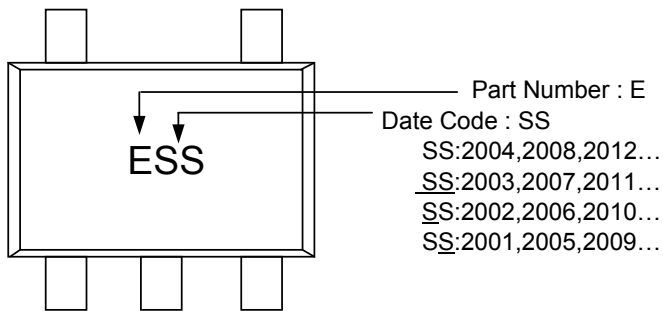

SOT-23-5LR

