

NOA1212

Ambient Light Sensor with Dark Current Compensation

Description

The NOA1212 is a very low power ambient light sensor (ALS) with an analog current output and a power down mode to conserve power. Designed primarily for handheld device applications, the active power dissipation of this chip is less than 8 μA at dark and its quiescent current consumption is less than 200 pA in power down mode. The device can operate over a very wide range of voltages from 2 V to 5.5 V. The NOA1212 employs proprietary CMOS image sensing technology from ON Semiconductor, including built-in dynamic dark current compensation to provide large signal to noise ratio (SNR) and wide dynamic range (DR) over the entire operating temperature range. The photopic optical filter provides a light response similar to that of the human eye. Together the photopic light response and dark current compensation insures accurate light level detection.

Features

- Senses Ambient Light and Provides an Output Current Proportional to the Ambient Light Intensity
- Photopic Spectral Response
- Dynamic Dark Current Compensation
- Three Selectable Output Current Gain Modes in 10x Steps
- Power Down Mode
- Less than 18 μA at 100 lux Active Power Consumption in Medium Gain Mode (Less than 8 μA at Dark)
- Less than 200 pA Quiescent Power Dissipation in Power Down Mode at All Light Levels
- Linear Response Over the Full Operating Range
- Senses Intensity of Ambient Light from ~0 lux to Over 100,000 lux
- Wide Operating Voltage range (2 V to 5.5 V)
- Wide operating temperature range (-40°C to 85°C)
- Drop-in Replacement Device in 1.6 x 1.6 mm Package
- These Devices are Pb-Free, Halogen Free/BFR Free and are RoHS Compliant

Applications

- Saves display power in applications such as:
 - ◆ Cell Phones, PDAs, MP3 players, GPS
 - ◆ Cameras, Video Recorders
 - ◆ Mobile Devices with Displays or Backlit Keypads
 - ◆ Laptops, Notebooks, Digital Signage
 - ◆ LCD TVs and Monitors, Digital Picture Frames
 - ◆ Automobile Dashboard Displays and Infotainment
 - ◆ LED Indoor/Outdoor Residential and Street Lights



ON Semiconductor®

<http://onsemi.com>



CUDFN6
CU SUFFIX
CASE 505AE

PIN ASSIGNMENT

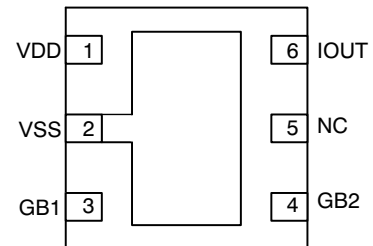

(Top View)

ORDERING INFORMATION

Device	Package	Shipping†
NOA1212CUTAG*	CUDFN6 (Pb-Free)	2500 / Tape & Reel

†For information on tape and reel specifications, including part orientation and tape sizes, please refer to our Tape and Reel Packaging Specifications Brochure, BRD8011/D.

*Temperature Range: -40°C to 85°C .

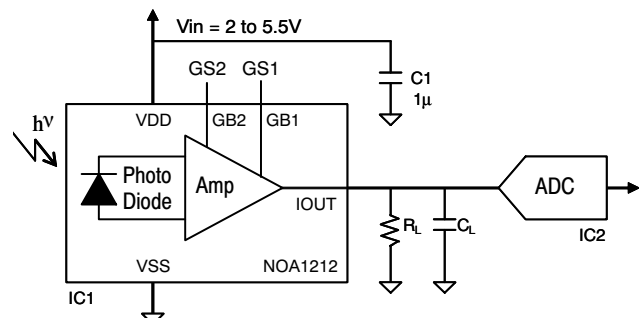

Figure 1. Typical Application Circuit

NOA1212

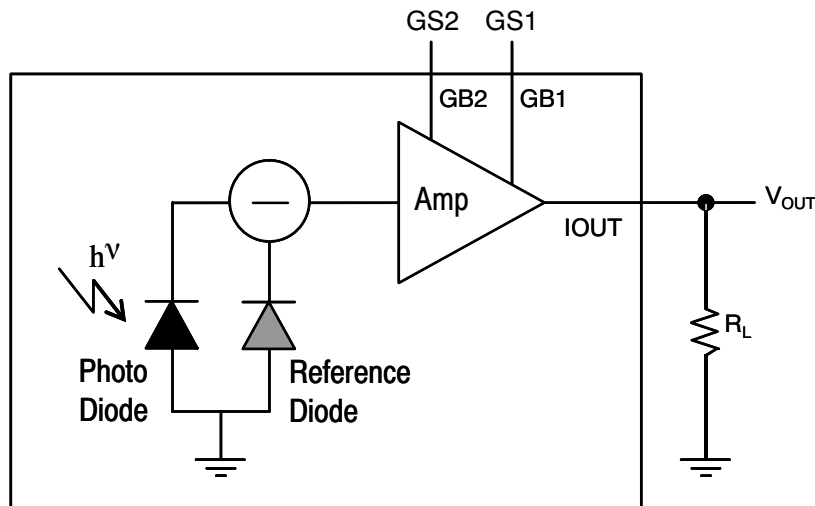

Figure 2. Simplified Block Diagram

Table 1. PIN FUNCTION DESCRIPTION

Pin	Pin Name	Description
1	VDD	Power pin.
2	VSS	Ground pin.
3	GB1	In conjunction with GB2, selects between three gain modes and power down.
4	GB2	In conjunction with GB1, selects between three gain modes and power down.
5	NC	Not connected. This may be connected to ground or left floating.
6	IOUT	Analog current output.
EP	VSS	Exposed pad, internally connected to ground. Should be connected to ground.

Table 2. ABSOLUTE MAXIMUM RATINGS

Rating	Symbol	Value	Unit
Input power supply	V_{DD}	6	V
Input voltage range	V_{IN}	-0.3 to $V_{DD} + 0.3$	V
Output voltage range	V_{OUT}	-0.3 to $V_{DD} + 0.2$	V
Output current range	I_o	0 to 15	mA
Maximum Junction Temperature	$T_{J(max)}$	-40 to 85	°C
Storage Temperature	T_{STG}	-40 to 85	°C
ESD Capability, Human Body Model (Note 1)	ESD_{HBM}	2	kV
ESD Capability, Charged Device Model (Note 1)	ESD_{CDM}	750	V
ESD Capability, Machine Model (Note 1)	ESD_{MM}	150	V
Moisture Sensitivity Level	MSL	5	-
Lead Temperature Soldering (Note 2)	T_{SLD}	260	°C

Stresses exceeding Maximum Ratings may damage the device. Maximum Ratings are stress ratings only. Functional operation above the Recommended Operating Conditions is not implied. Extended exposure to stresses above the Recommended Operating Conditions may affect device reliability.

- This device incorporates ESD protection and is tested by the following methods:
 - ESD Human Body Model tested per EIA/JESD22-A114
 - ESD Charged Device Model tested per ESD-STM5.3.1-1999
 - ESD Machine Model tested per EIA/JESD22-A115
 - Latchup Current Maximum Rating: ≤ 100 mA per JEDEC standard: JESD78
- For information, please refer to our Soldering and Mounting Techniques Reference Manual, SOLDERRM/D

NOA1212

Table 3. ELECTRICAL CHARACTERISTICS (Unless otherwise specified, these specifications apply over $V_{DD} = 5.5\text{ V}$, $-40^{\circ}\text{C} < T_A < 85^{\circ}\text{C}$)

Rating	Test Conditions	Symbol	Min	Typ	Max	Unit
Power supply voltage		V_{DD}	2	3.0	5.5	V
Power supply current	$V_{DD} = 3.0\text{ V}$, $E_v = 0\text{ lux}$, H-Gain	I_{DD_0}	6	8	12	μA
Power supply current	$V_{DD} = 3.0\text{ V}$, $E_v = 100\text{ lux}$, H-Gain	I_{DD_100}	32	64	96	μA
Power down current	All light levels	I_{DD_PD}		0.2	5	nA
Output current, high-gain	$E_v = 100\text{ lux}$, White LED	I_{o_high}	41	51	61.5	μA
Dark output current, high-gain	$V_{DD} = 3.0\text{ V}$, $E_v = 0\text{ lux}$	I_{o_dark}		10		nA
Wavelength of maximum response		λ_m		540		nm
White LED/fluorescent current ratio	$E_v = 100\text{ lux}$	r_{LE}		1.0		
Incandescent/fluorescent current ratio	$E_v = 100\text{ lux}$	r_{IF}		1.45		
Maximum output voltage	$E_v = 100\text{ lux}$, $R_L = 220\text{ k}\Omega$, H-Gain	V_{OMAX}	$V_{DD}-0.4$	$V_{DD}-0.1$	V_{DD}	V
Power down time	$E_v = 100\text{ lux}$, H-Gain to PD	t_{PD}	1.5			ms
Wake up time	$E_v = 100\text{ lux}$, PD to H-Gain	t_{wu}			300	μs
Low level input voltage		V_{IL}	-0.2		$0.25 V_{DD}$	V
High level input voltage		V_{IH}	$0.75 V_{DD}$		$V_{DD}+0.2$	V
Operating free-air temperature range		T_A	-40		85	$^{\circ}\text{C}$

TYPICAL CHARACTERISTICS

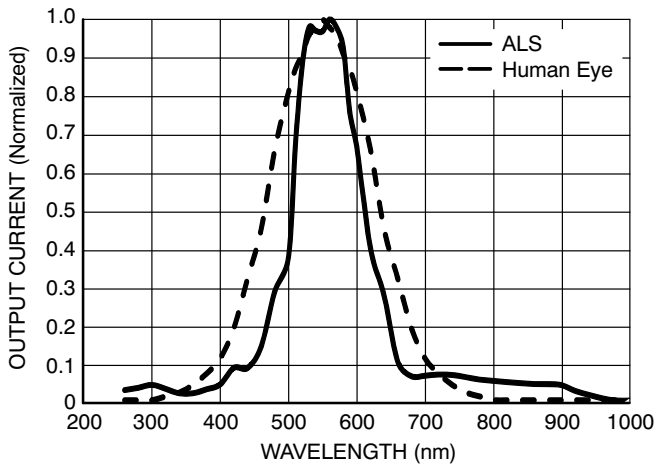

Figure 3. Spectral Response (Normalized)

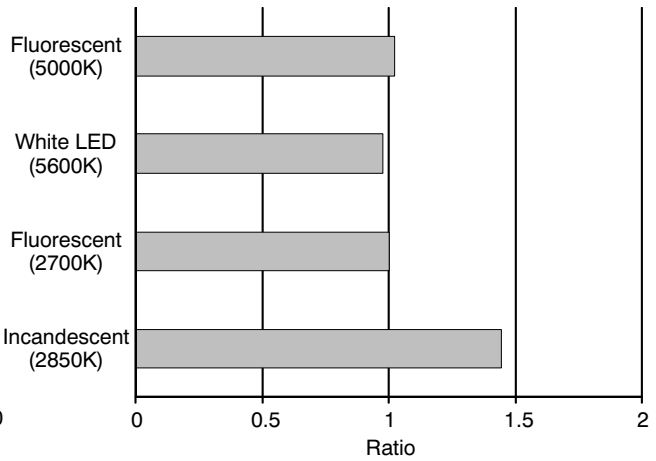

Figure 4. Light Source Dependency (Normalized to Fluorescent Light)

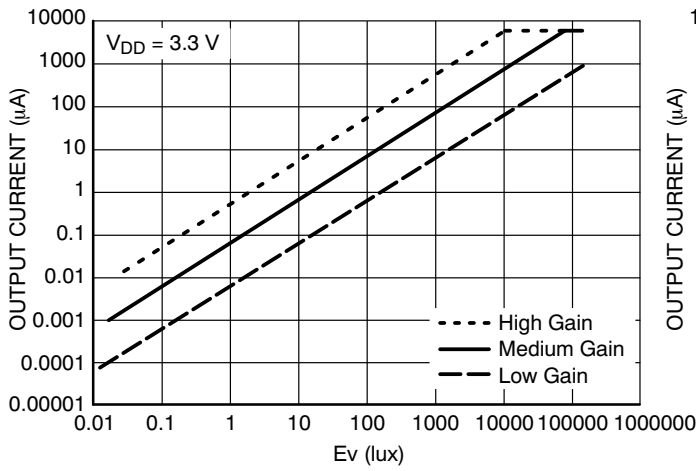

Figure 5. Output Current vs. Ev

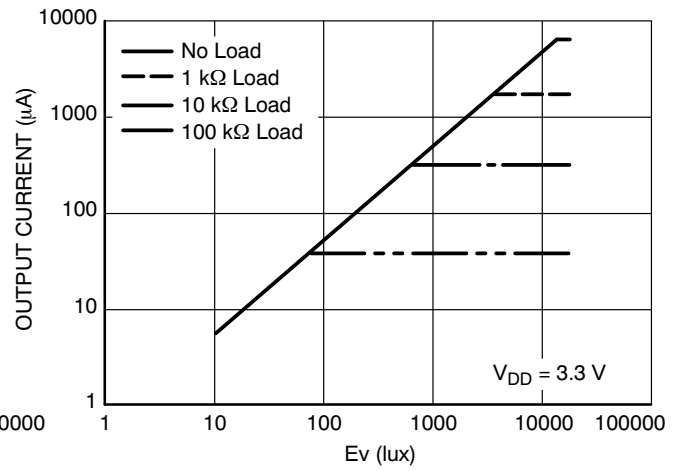

Figure 6. Output Current vs. Ev (High Gain Mode)

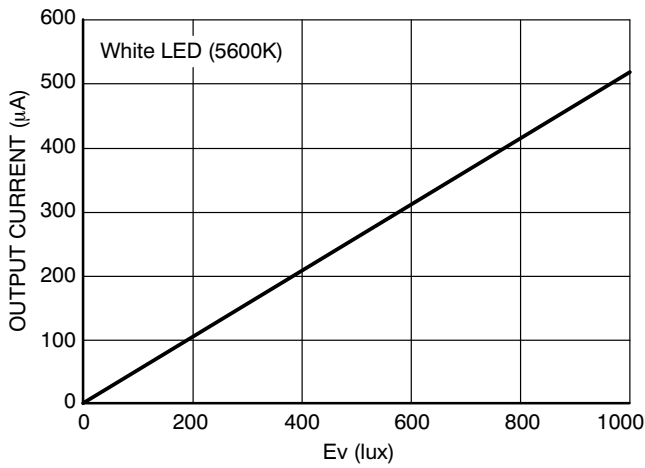

Figure 7. Output Current vs. Ev, 0-1000 lux (High Gain Mode)

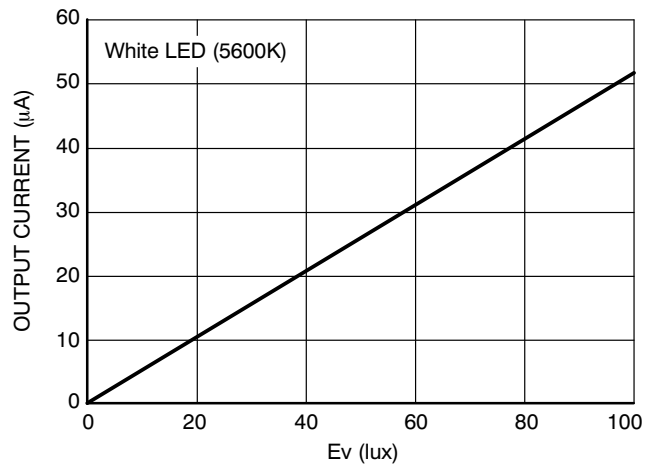

Figure 8. Output Current vs. Ev, 0-100 lux (High Gain Mode)

TYPICAL CHARACTERISTICS

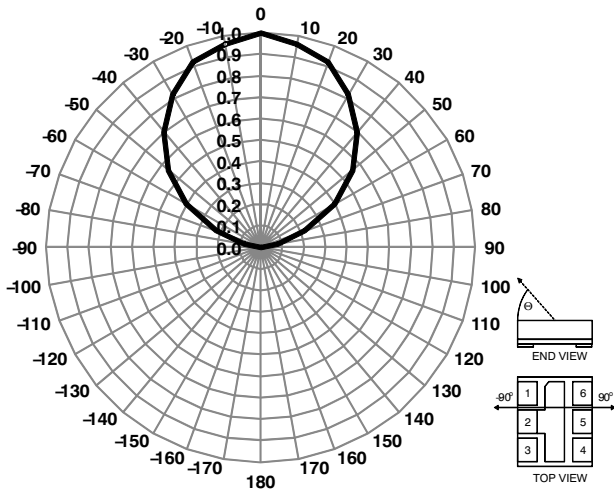

Figure 9. Output Current vs. Angle (End View, Normalized)

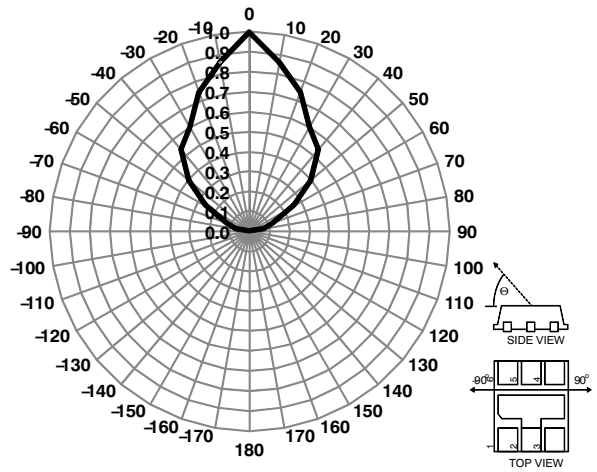

Figure 10. Output Current vs. Angle (Side View, Normalized)

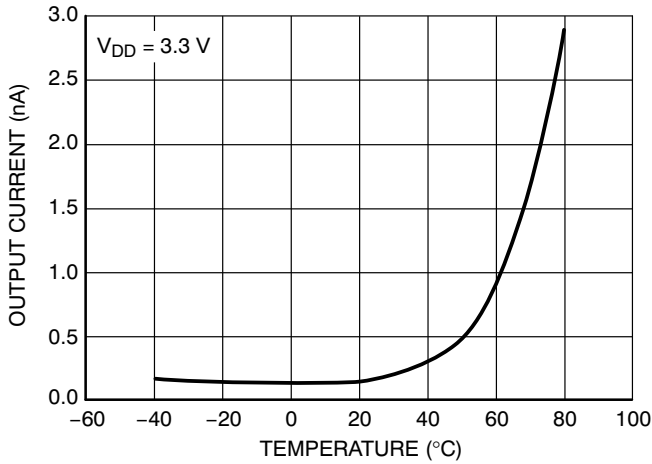

Figure 11. Output Current at 0 lux vs. Temperature (High Gain Mode)

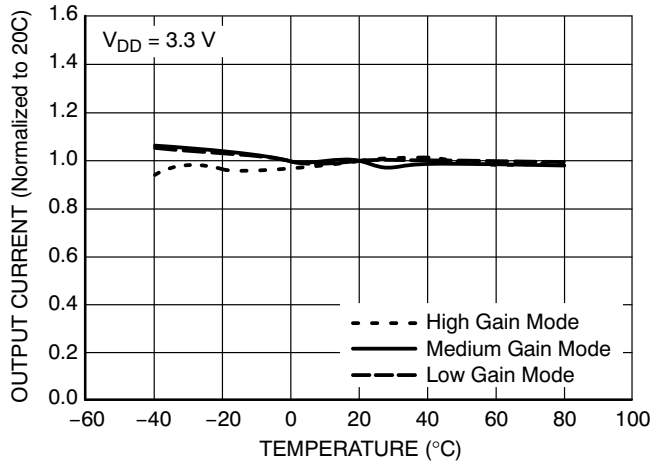

Figure 12. Output Current at 100 lux vs. Temperature

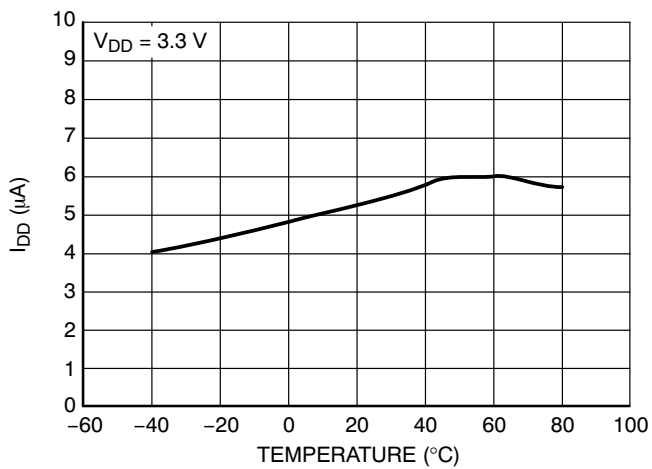

Figure 13. Supply Current at 0 lux vs. Temperature (High Gain Mode)

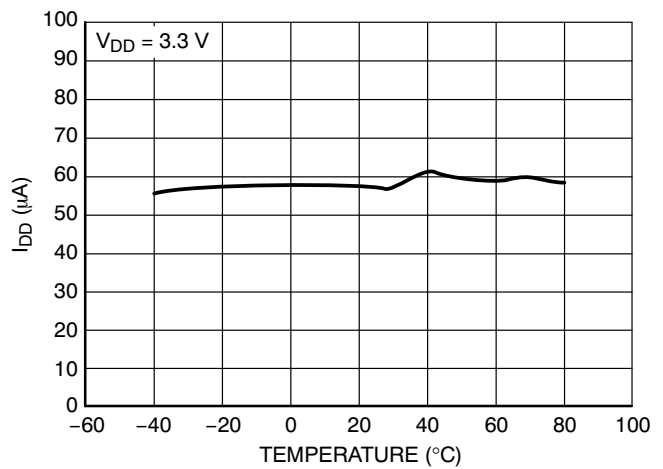

Figure 14. Supply Current at 100 lux vs. Temperature (High Gain Mode)

NOA1212

TYPICAL CHARACTERISTICS

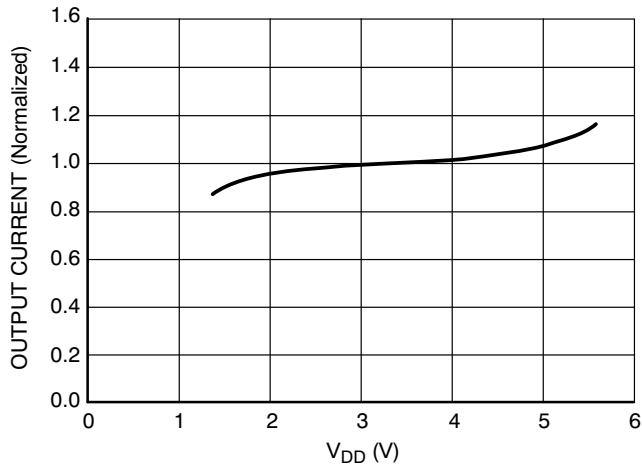

Figure 15. Output Current at 100 lux vs. Supply Voltage (High Gain Mode)

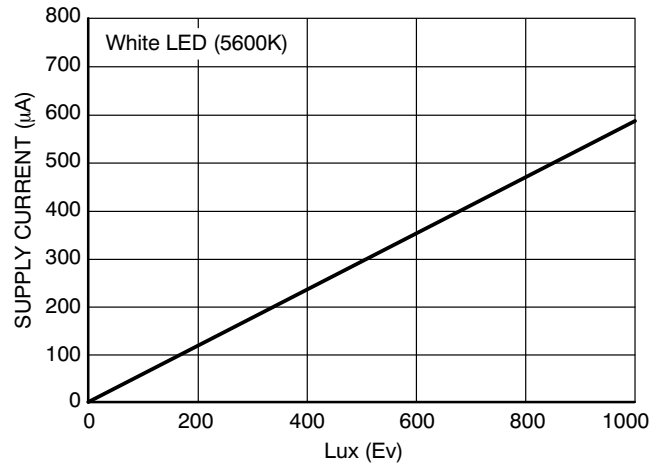

Figure 16. Supply Current vs. Ev (High Gain Mode)

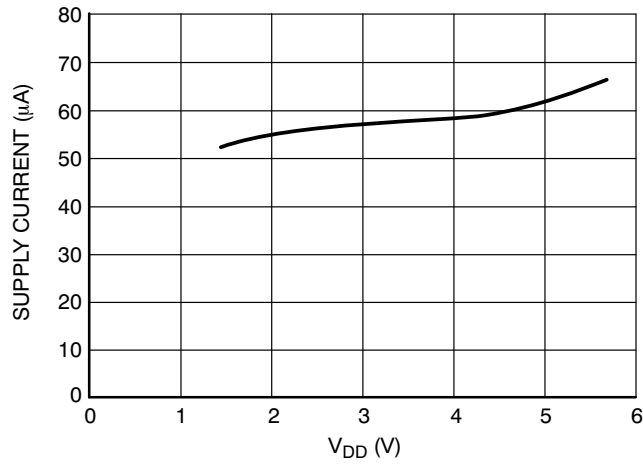

Figure 17. Supply Current vs. Supply Voltage (High Gain Mode)

DESCRIPTION OF OPERATION

Ambient Light Sensor Architecture

The NOA1212 employs a sensitive photo diode fabricated in ON Semiconductor's standard CMOS process technology. The major components of this sensor are as shown in Figure 2. The photons which are to be detected pass through an ON Semiconductor proprietary color filter limiting extraneous photons and thus performing as a band pass filter on the incident wave front. The filter only

transmits photons in the visible spectrum which are primarily detected by the human eye and exhibits excellent IR rejection. The photo response of this sensor is as shown in Figure 3.

The ambient light signal detected by the photo diode is converted to an analog output current by an amplifier with programmable gain. Table 4 shows the gain setting and the corresponding light sensitivity.

Table 4. PROGRAMMABLE GAIN SETTINGS

GB2	GB1	Mode	Approximate Output Current @ 100 lux	Approximate Output Current @ 1000 lux	Saturation
0	0	Power Down	–	–	–
0	1	High Gain	51 μ A	510 μ A	~10,000 lux
1	0	Medium Gain	5.1 μ A	51 μ A	~100,000 lux
1	1	Low Gain	0.51 μ A	5.1 μ A	> 100,000 lux

Power Down Mode

This device can be placed in a power down mode by setting GB1 and GB2 to logic low level.

In order for proper operation of this mode GB1 and GB2 should stay low 1.5 ms.

External Component Selection

The NOA1212 outputs a current in direct response to the incident illumination. In many applications it is desirable to convert the output current into voltage. It may also be desirable to filter the effects of 50/60 Hz flicker or other light source transients.

Conversion from current to voltage may be accomplished by adding load resistor R_L to the output. The value of R_L is bounded on the high side by the potential output saturation of the amplifier at high ambient light levels. R_L is bounded on the low side by the output current limiting of the internal amplifier and to minimize power consumption.

Equation 1 describes the relationship of light input to current output for the High-Gain mode.

$$I_{OUT} = (51 \mu\text{A}/100 \text{ lux}) * E_V \quad (\text{eq. 1})$$

By adding R_L to the output, I_{OUT} is converted into a voltage according to Equation 2.

$$V_{OUT} = I_{OUT} * R_L = (51 \mu\text{A}/100 \text{ lux}) * E_V * R_L \quad (\text{eq. 2})$$

The range of the output voltage is limited by the output stage to the V_{OMAX} parameter value of $V_{DD} - 0.4 \text{ V}$ at the

maximum desired E_V as shown in Equation 3. Equation 4 computes the value for R_L (High-Gain mode).

$$V_{OMAX} = (51 \mu\text{A}/100 \text{ lux}) * E_{VMAX} * R_L \quad (\text{eq. 3})$$

$$R_L = (V_{DD} - 0.4 \text{ V})/E_{VMAX} * (100 \text{ lux}/51 \mu\text{A}) \quad (\text{eq. 4})$$

For example, consider a 5 V supply with a desired $E_{VMAX} = 1000 \text{ lux}$, the value of R_L would be 8.85 k Ω . The value for R_L can easily be computed for different NOA1212 gain ranges by substituting the appropriate output current at 100 lux from Table 4.

The optional capacitor C_L can be used to form a low-pass filter to remove 50/60 Hz filter or other unwanted noise sources as computed with Equation 5.

$$C_L = 1/2\pi f_c R_L \quad (\text{eq. 5})$$

For our example, to filter out 60Hz flicker the value of C_L would be 300 nF.

Power Supply Bypassing and Printed Circuit Board Design

Power supply bypass and decoupling can typically be handled with a low cost 0.1 μ F to 1.0 μ F capacitor.

The exposed pad on the bottom of the package is internally connected to VSS pin 2 and should be soldered to the printed circuit board.

NOA1212

PACKAGE DIMENSIONS

CUDFN6, 1.6x1.6 CASE 505AE ISSUE B

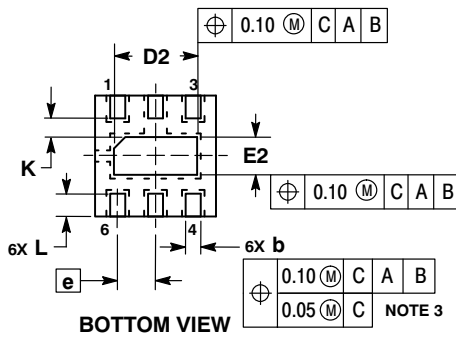
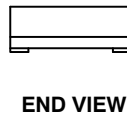
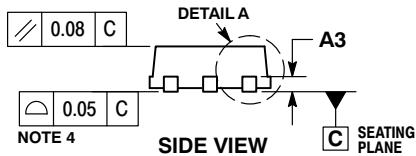
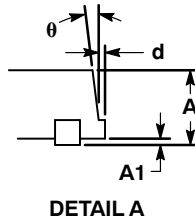
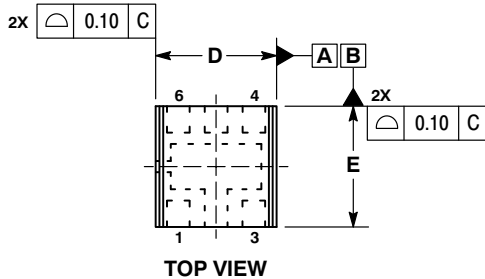

NOTES:

1. DIMENSIONING AND TOLERANCING PER ASME Y14.5M, 1994.
2. CONTROLLING DIMENSION: MILLIMETERS.
3. DIMENSION b APPLIES TO PLATED TERMINAL AND IS MEASURED BETWEEN 0.15 AND 0.30mm FROM THE TERMINAL TIP.
4. COPLANARITY APPLIES TO THE EXPOSED PAD AS WELL AS THE TERMINALS.

MILLIMETERS		
DIM	MIN	MAX
A	0.55	0.65
A1	0.00	0.05
A3	0.20 REF	
b	0.15	0.25
D	1.60 BSC	
d	---	0.10
D2	1.00	1.20
E	1.60 BSC	
E2	0.40	0.60
e	0.50 BSC	
K	0.20	---
L	0.25	0.35
θ	4°	10°

MOUNTING FOOTPRINT

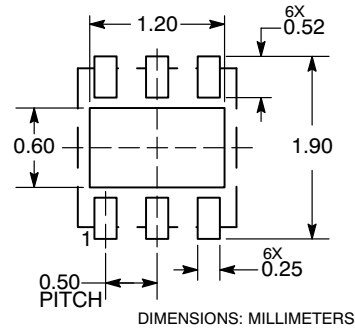

*For additional information on our Pb-Free strategy and soldering details, please download the ON Semiconductor Soldering and Mounting Techniques Reference Manual, SOLDERRM/D.

ON Semiconductor and are registered trademarks of Semiconductor Components Industries, LLC (SCILLC). SCILLC owns the rights to a number of patents, trademarks, copyrights, trade secrets, and other intellectual property. A listing of SCILLC's product/patent coverage may be accessed at www.onsemi.com/site/pdf/Patent-Marking.pdf. SCILLC reserves the right to make changes without further notice to any products herein. SCILLC makes no warranty, representation or guarantee regarding the suitability of its products for any particular purpose, nor does SCILLC assume any liability arising out of the application or use of any product or circuit, and specifically disclaims any and all liability, including without limitation special, consequential or incidental damages. "Typical" parameters which may be provided in SCILLC data sheets and/or specifications can and do vary in different applications and actual performance may vary over time. All operating parameters, including "Typicals" must be validated for each customer application by customer's technical experts. SCILLC does not convey any license under its patent rights nor the rights of others. SCILLC products are not designed, intended, or authorized for use as components in systems intended for surgical implant into the body, or other applications intended to support or sustain life, or for any other application in which the failure of the SCILLC product could create a situation where personal injury or death may occur. Should Buyer purchase or use SCILLC products for any such unintended or unauthorized application, Buyer shall indemnify and hold SCILLC and its officers, employees, subsidiaries, affiliates, and distributors harmless against all claims, costs, damages, and expenses, and reasonable attorney fees arising out of, directly or indirectly, any claim of personal injury or death associated with such unintended or unauthorized use, even if such claim alleges that SCILLC was negligent regarding the design or manufacture of the part. SCILLC is an Equal Opportunity/Affirmative Action Employer. This literature is subject to all applicable copyright laws and is not for resale in any manner.

PUBLICATION ORDERING INFORMATION

LITERATURE FULFILLMENT:
Literature Distribution Center for ON Semiconductor
P.O. Box 5163, Denver, Colorado 80217 USA
Phone: 303-675-2175 or 800-344-3860 Toll Free USA/Canada
Fax: 303-675-2176 or 800-344-3867 Toll Free USA/Canada
Email: orderlit@onsemi.com

N. American Technical Support: 800-282-9855 Toll Free
USA/Canada
Europe, Middle East and Africa Technical Support:
Phone: 421 33 790 2910
Japan Customer Focus Center
Phone: 81-3-5817-1050

ON Semiconductor Website: www.onsemi.com
Order Literature: <http://www.onsemi.com/orderlit>

For additional information, please contact your local Sales Representative