

SPECIFICATION

- Part No. : FW.45.B.SMA.M
- Description : Meteor
450-470MHz Flexible Whip Monopole
Antenna SMA(M) Straight
- Features : Monopole Antenna
Designed for Outdoor Use
Over 70% high efficiency*
Over 1 dBi peak gain*
Robust Inner Steel Core
Antenna Length: 290mm
SMA Type(M) Straight Connector
IP65 dust and water-resistant
*Tested on 30cm*30cm Ground Plane
RoHS Compliant



1. Introduction

The FW.45 is a flexible 450-470MHz whip antenna with a SMA type (M) connector for outdoor use. It features excellent efficiency (>70%) and peak gain (>1 dBi) at 450-470MHz on a 30x30 cm ground plane. Common applications are smart metering, gateways, wireless monitoring, and mesh networks.

The FW.45 has an excellent omnidirectional radiation pattern, ensuring wide coverage. The antenna's high efficiency means that it allows your radio to consume less power than with a lower efficiency antenna when transferring data. It also means a better signal strength and better sensitivity in areas of low signal levels. The antenna performs at its best while attached to a ground plane with dimensions of at least 30x30 cm. For an environment where there is no ground-plane available we recommend to use the fiberglass omni OMB.450 antenna.

The FW.45 whip is made of a flexible inner steel core covered by PE so it is extremely resistant to abrasion and maintains its original shape and RF performance even after shock. This rugged design and IP67 rating on the housing ensure high reliability.

This antenna comes with SMA(M) connector as standard. Other custom variants can be provided subject to NRE and MOQ. Contact your regional Taoglas office for details.

2. Specification

CDMA450 450-470MHz	
Center Frequency	450-470 MHz
Design Environment	On 30x30cm ground
Efficiency	73.66 %
Peak Gain	1.10 dBi
Return loss	< -10 dB
VSWR	≤ 2:1
Impedance	50 Ω
Polarization	Linear
Radiation Pattern	Omnidirectional
Input Power	2 W
MECHANICAL	
Dimensions	Length 290 ± 9 mm
Base Diameter	16 ± 0.6 mm
Whip Diameter	6.2 ± 0.6 mm
Casing	ABS
Connector	SMA Type(M) Straight
Weight	63.5 g
Dust and Water Resistance	IP65
ENVIRONMENTAL	
Temperature Range	-40°C to 85°C
Humidity	Non-condensing 65°C 95% RH

3. Antenna Characteristics

3.1. Return Loss

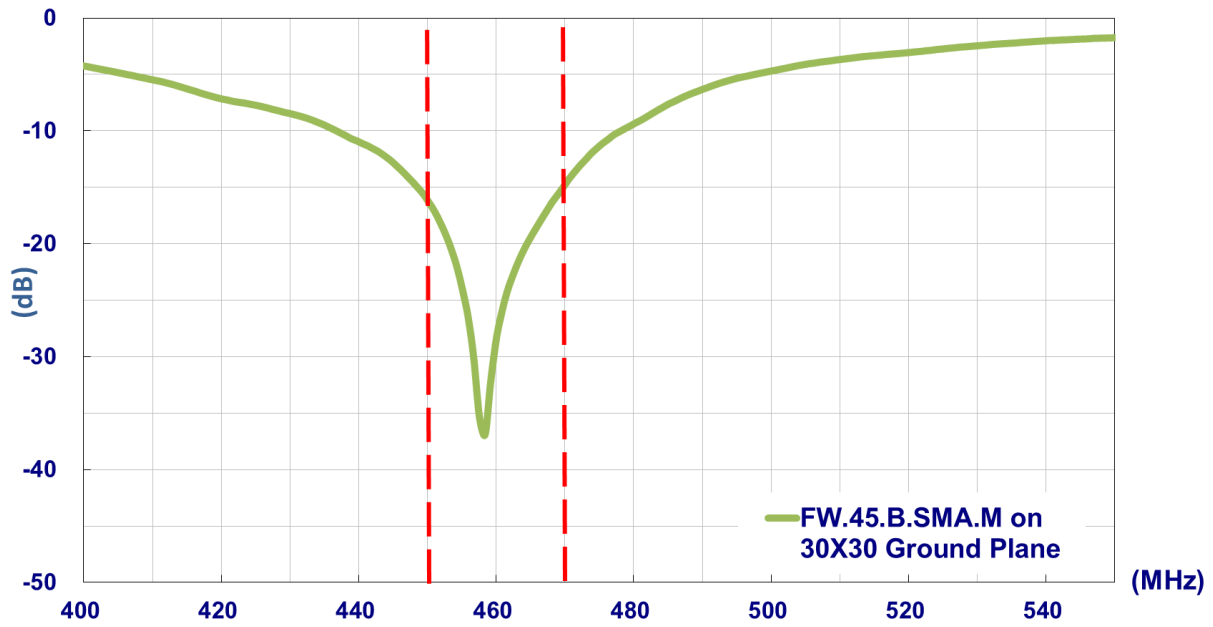

3.2. Antenna Efficiency

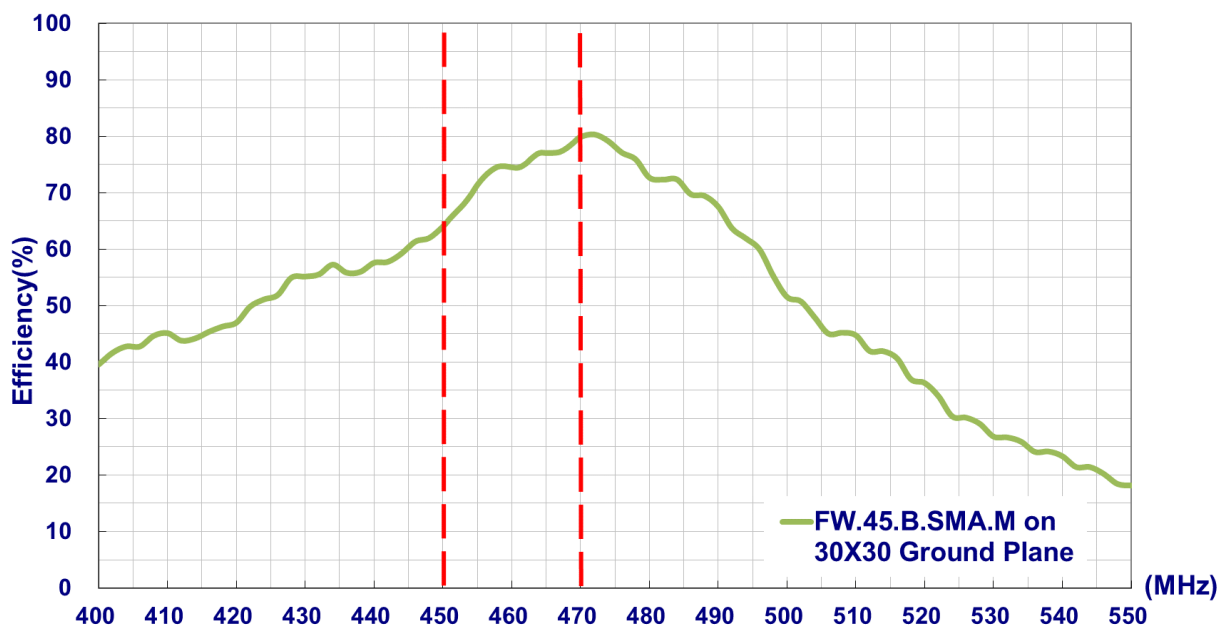

3.3. Peak Gain

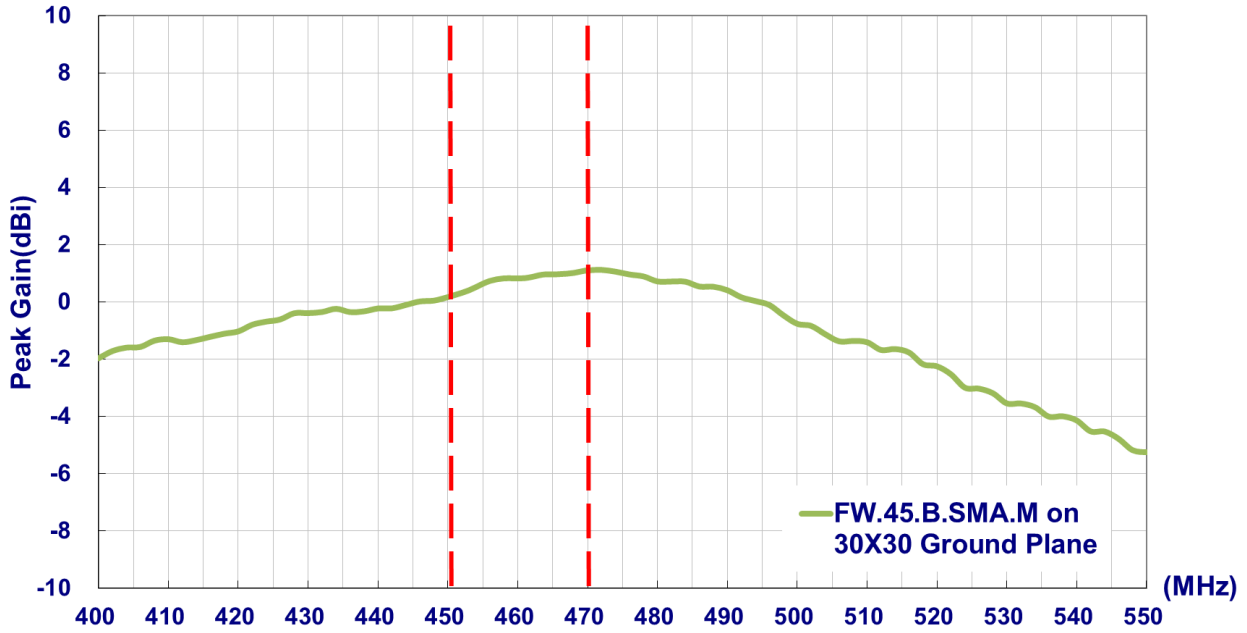

3.4. Average Gain

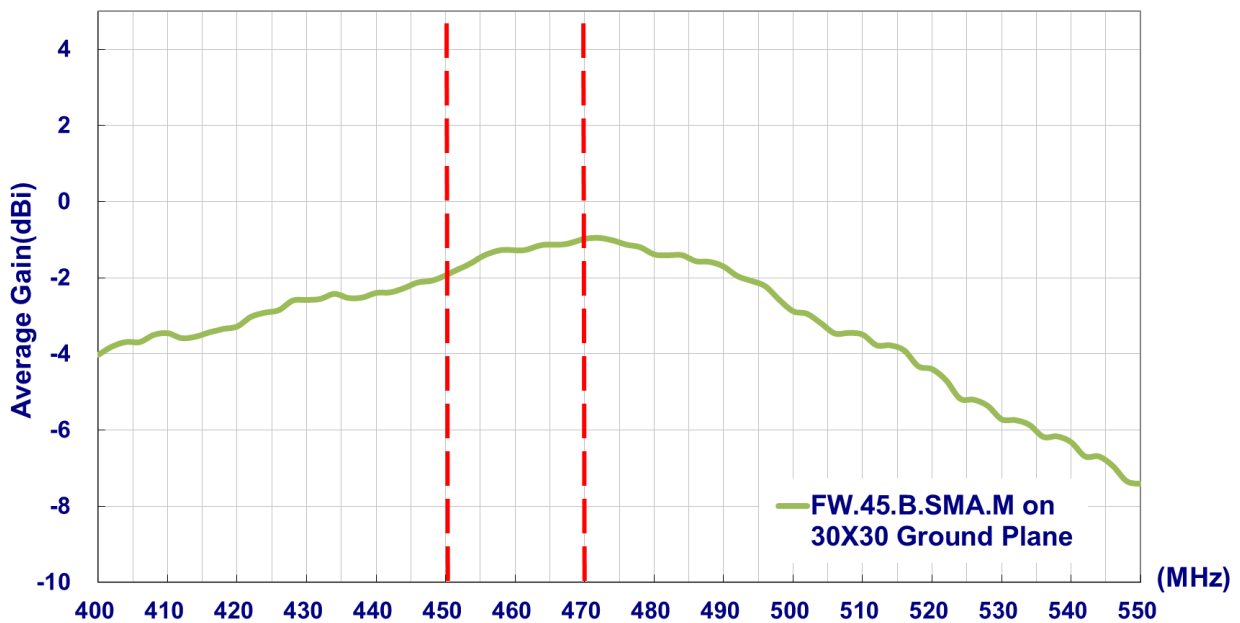

4. Antenna Radiation Pattern

4.1. Antenna Setup

On 30*30 cm ground plane

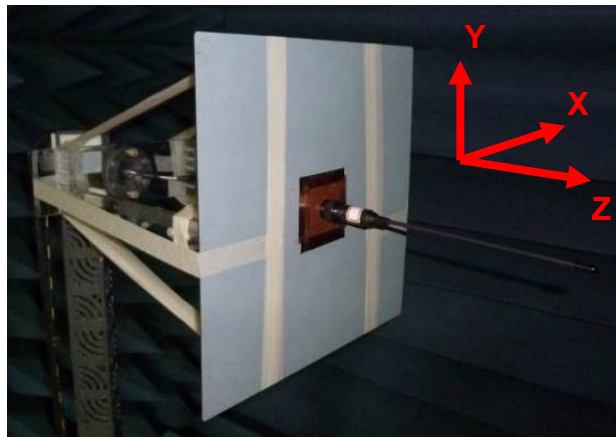

4.2. 2-D Radiation Pattern

- On 30*30cm Ground Plane

XY Plane

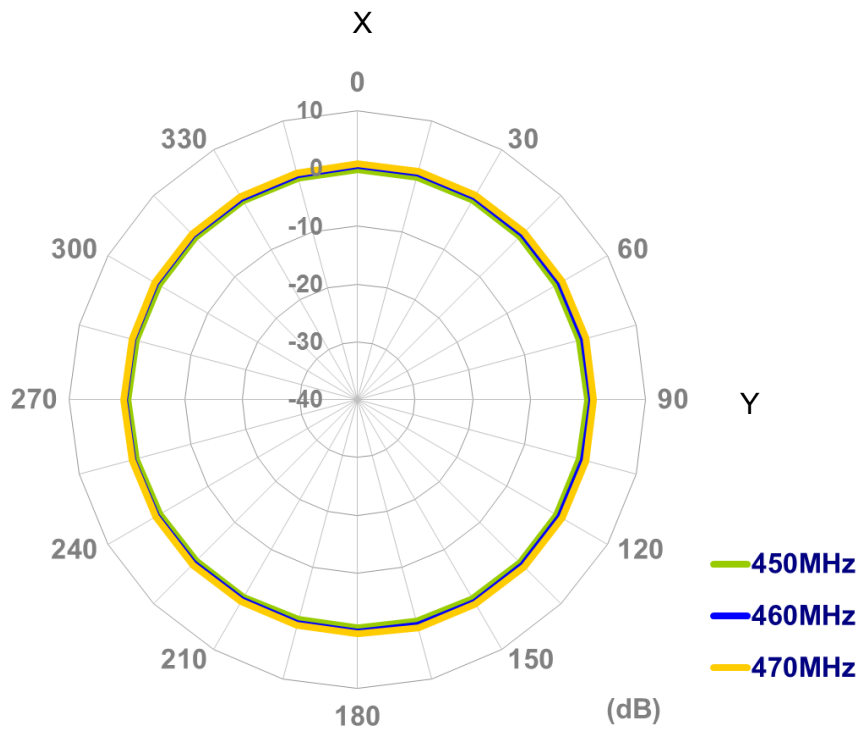

XZ Plane

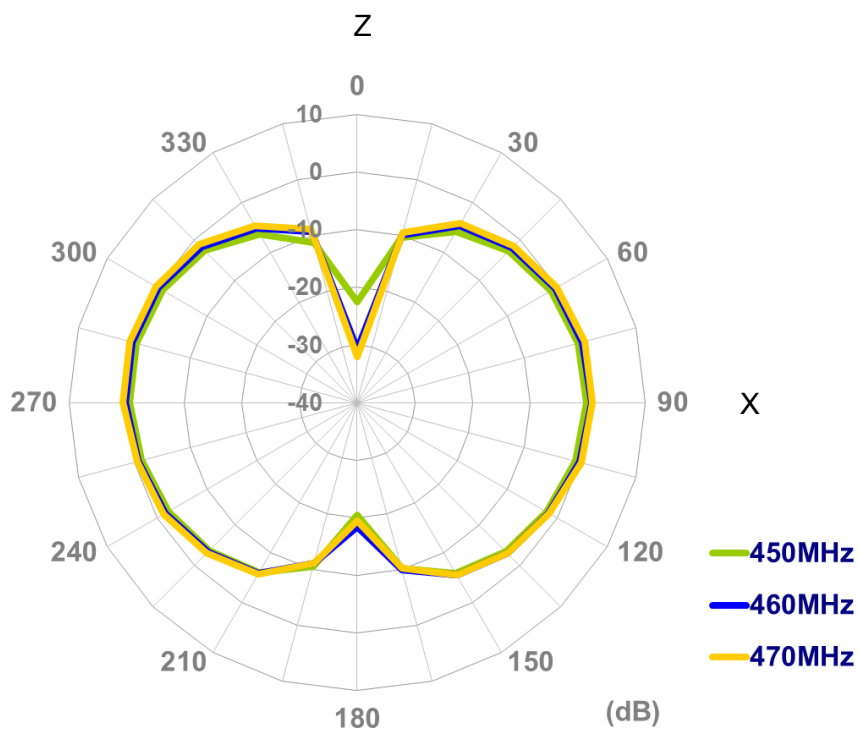

YZ Plane

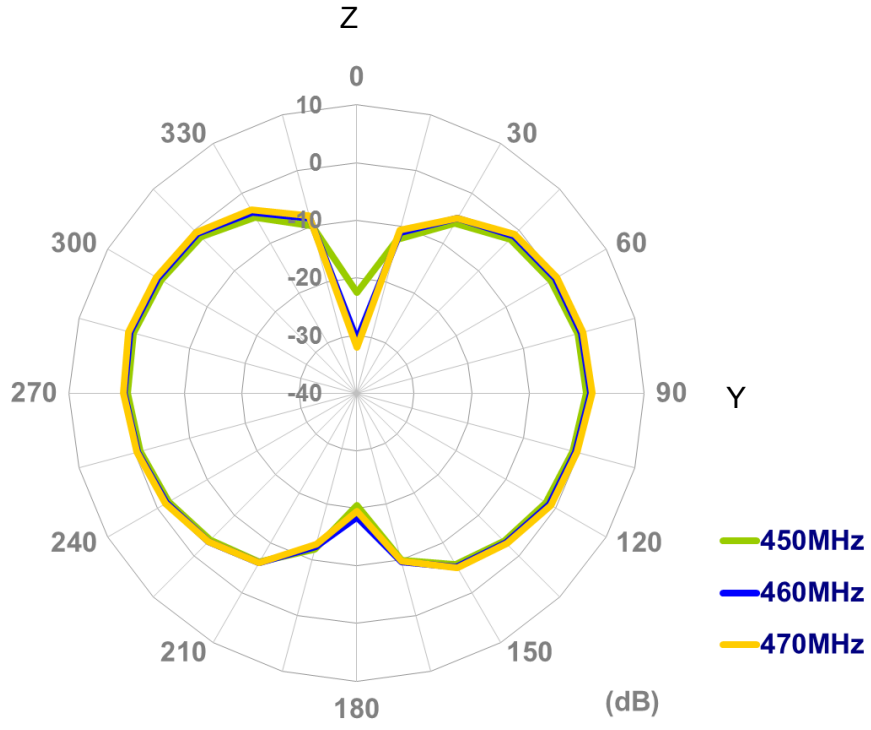

4.3. 3-D Radiation Pattern

- On 30*30cm Ground Plane

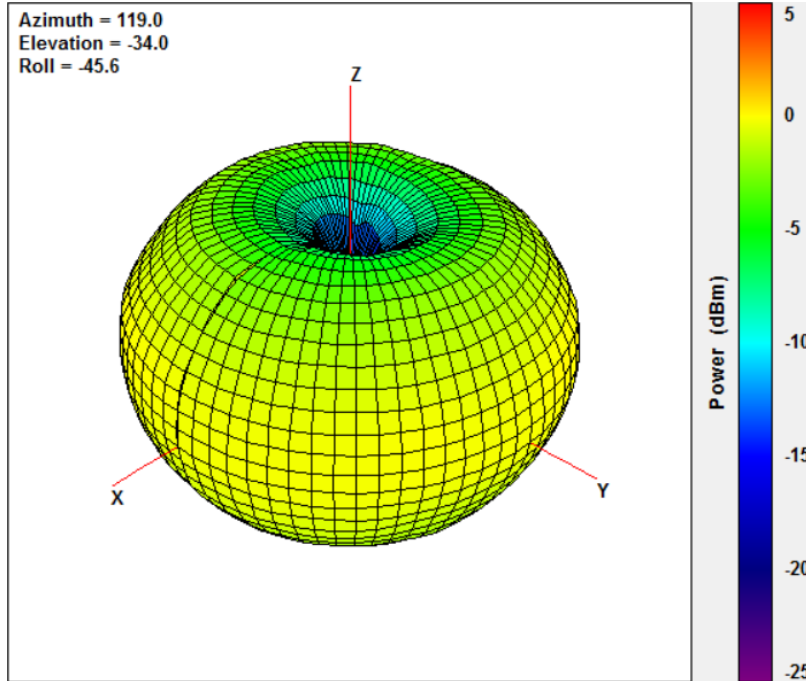

@ 450MHz

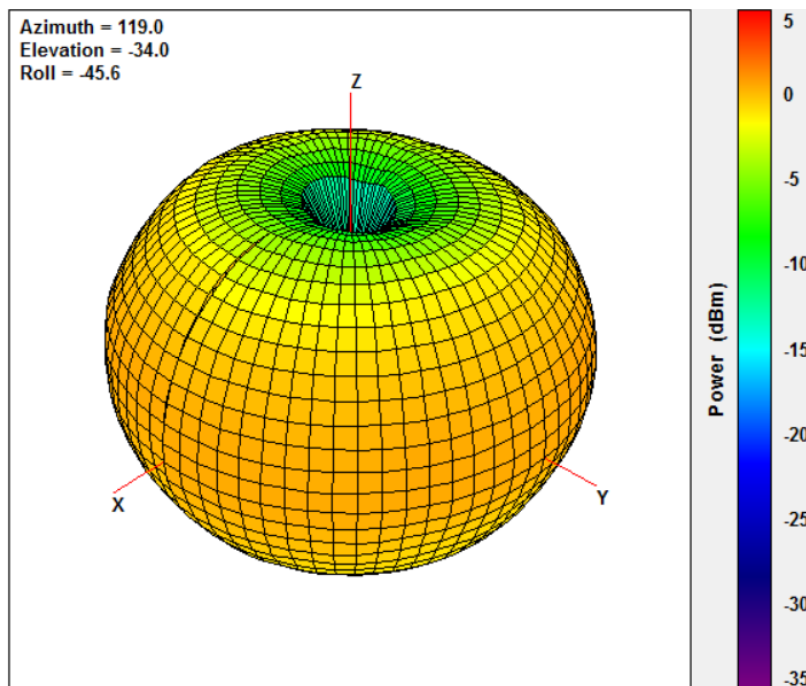

@ 460MHz

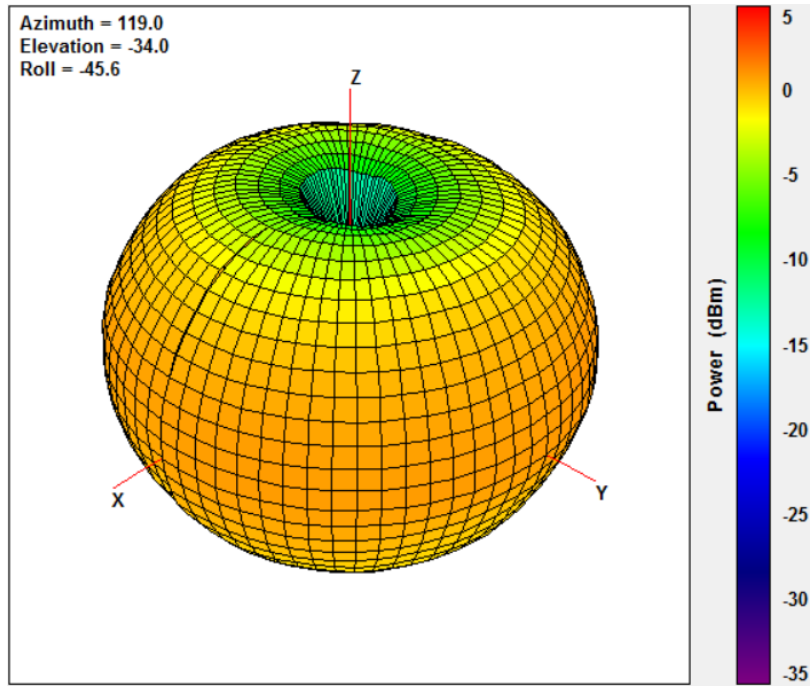

@ 470MHz

5. Antenna Drawing (Unit: mm)

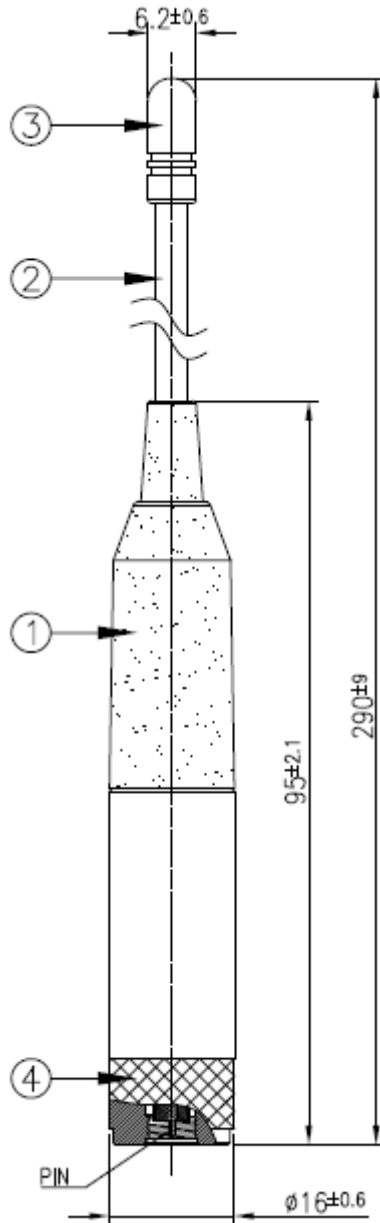

	Name	Material	Finish	QTY
1	Housing	ABS	Black	1
2	Flexible Whip	Steel+PE Jacket	Black	1
3	Cap	ABS	Black	1
4	SMA(M)ST	Brass	Black	1

6. Packaging

FW.45.B.SMA.M Packaging Specifications

1 pcs FW.45.B.SMA.M per PE Bag
PE Bag Dimensions - 400*50mm
Weight - 63.5g

50 PE Bags per Large PE Bag
50 pcs FW.45.B per Large PE Bag
Large PE Bag Dimensions - 520*360mm
Weight - 3.4kg

4 Large PE Bags per carton
200 pcs FW.45.B per carton
Carton Dimensions - 360*310*160mm
Weight - 13.6kg

Pallet Dimensions 1200*1000*1350mm
63 Cartons per Pallet
9 Cartons per Layer
7 Layers

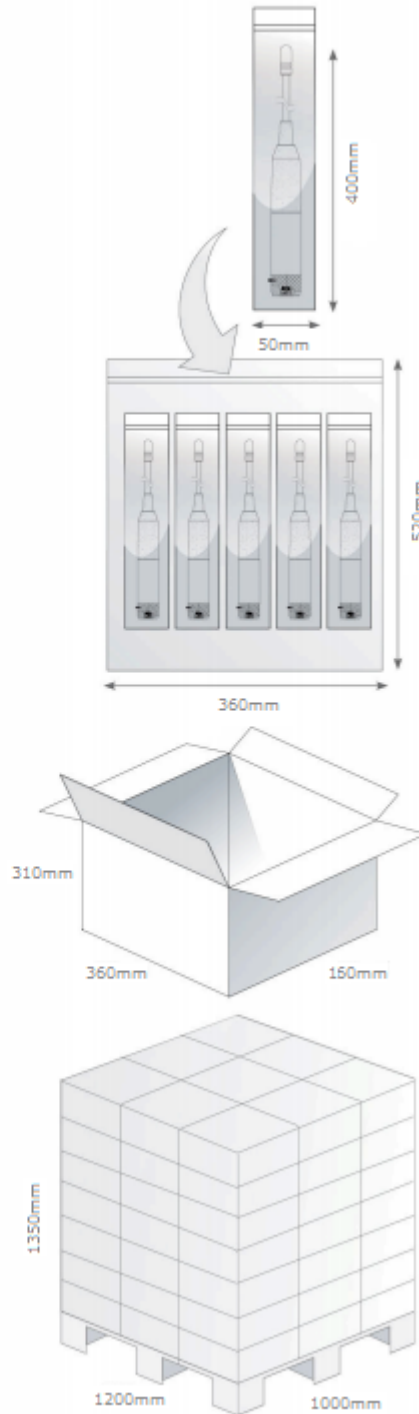



Taoglas makes no warranties based on the accuracy or completeness of the contents of this document and reserves the right to make changes to specifications and product descriptions at any time without notice. Taoglas reserves all rights to this document and the information contained herein.

Reproduction, use or disclosure to third parties without express permission is strictly prohibited.

Copyright © Taoglas Ltd.