

## 4-Channel Low Capacitance ESD Protection Diodes Array

### ESD05V06S-4L

#### Description

The ESD05V06S-4L is a 4-channel ultra low capacitance rail clamp ESD protection diodes array. Each channel consists of a pair of ESD diodes that steer positive or negative ESD current to either the positive or negative rail. A zener diode is integrated in to the array between the positive and negative supply rails.

In the typical applications, the negative rail pin (assigned as GND) is connected with system ground. The Positive ESD current is steered to the ground through an ESD diode and Zener diode and the positive ESD voltage is clamped to the zener voltage. The ESD05V06S-4L is ideal to protect high speed data lines. Three package type is provided for easy PCB layout.

#### Features

- u 4 Channels of ESD Protection
- u Provides ESD Protection to IEC61000-4-2 level 4  $\pm 15\text{kV}$  air discharge;  $\pm 8\text{kV}$  contact discharge
- u Channel I/O to GND Capacitance:  $0.9\text{pF}$ (Max)
- u Channel I/O to I/O Capacitance:  $0.45\text{pF}$ (Max)
- u Low Clamping Voltage
- u Low Operating Voltage
- u Improved Zener Structure
- u Optimized Package for Easy High Speed Data Lines PCB layout
- u RoHS Compliant
- u S-Prefix for Automotive and Other Applications Requiring Unique Site and Control Change Requirements; AEC-Q101 Qualified and PPAP Capable.

SO-06

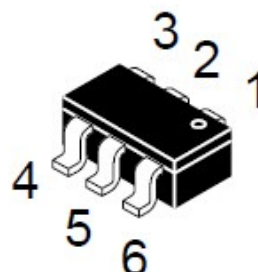

#### Pin Configuration

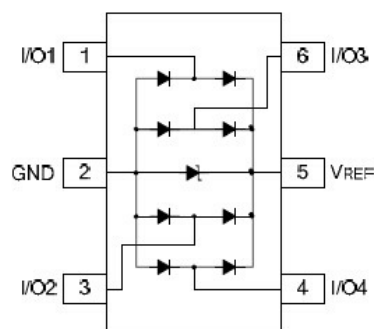

SO-06  
(Top View)

#### Applications

- u HDMI / DVI Ports
- u Display Port Interface
- u 10M / 100M / 1G Ethernet
- u USB 2.0 Interface
- u VGA Interface
- u Set-top Box
- u Flat Panel Monitors / TVs
- u PC / Note Book

#### Ordering Information

Part No.	Package	Marking	Material	Shipping
ESD05V06S-4L	SO-06	C96	Halogen Free	3000Tape&Reel

## 4-Channel Low Capacitance ESD Protection Diodes Array

### ESD05V06S-4L

#### Absolute Maximum Ratings

Characteristics	Symbol	Ratings	Unit
Peak Pulse Power (8/20 $\mu$ s)	$P_{PP}$	150	W
Peak Pulse Current (8/20 $\mu$ s)	$I_{PP}$	5	A
ESD per IEC 61000-4-2 (Air)	$V_{ESD1}$	$\pm 15$	kV
ESD per IEC 61000-4-2 (Contact)	$V_{ESD2}$	$\pm 8$	kV
Operating Temperature Range	$T_{OPR}$	-55 ~ +125	$^{\circ}C$
Storage Temperature Range	$T_{STG}$	-55 ~ +150	$^{\circ}C$

#### Electrical Characteristics ( $T_{AMB}=25^{\circ}C$ )

Characteristics	Symbol	Test Conditions	Min.	Typ.	Max.	Unit
Reverse Working Voltage	$V_{RWM}$	Any I/O pin to GND			5	V
Reverse Breakdown Voltage	$V_{BR}$	$I_t=1mA$ ; Any I/O pin to GND	6			V
Reverse Leakage Current	$I_R$	$V_{RWM}=5V$ , $T=25^{\circ}C$ ; Any I/O pin to GND			1	$\mu A$
Positive Clamping Voltage	$V_{C1}$	$I_{PP}=1A$ , $t_p=8/20\mu s$ ; Positive pulse; Any I/O pin to GND		8.5	12.0	V
Negative Clamping Voltage	$V_{C2}$	$I_{PP}=1A$ , $t_p=8/20\mu s$ ; Negative pulse; Any I/O pin to GND		1.8		V
Junction Capacitance Between Channel	$C_{J1}$	$V_R=0V$ , $f=1MHz$ ; Between I/O pins		0.35	0.45	pF
Junction Capacitance Between I/O And GND	$C_{J2}$	$V_R=0V$ , $f=1MHz$ ; Any I/O pin to GND			0.9	pF

#### Typical Electrical Characteristics Curve

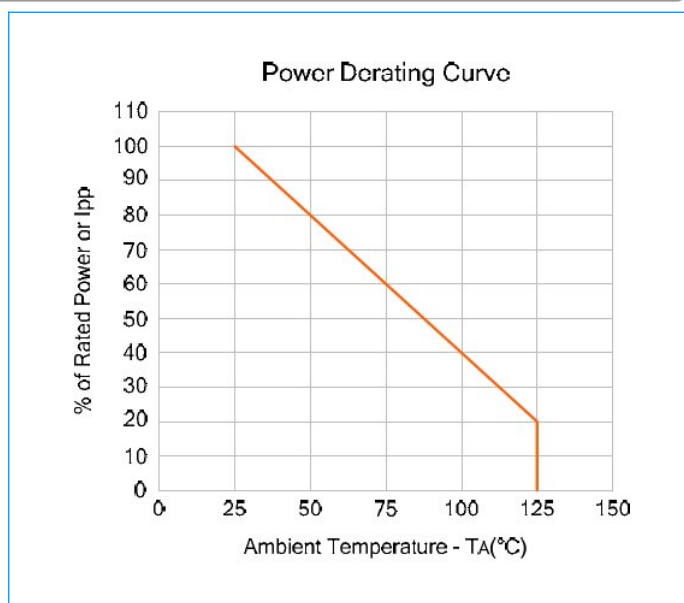
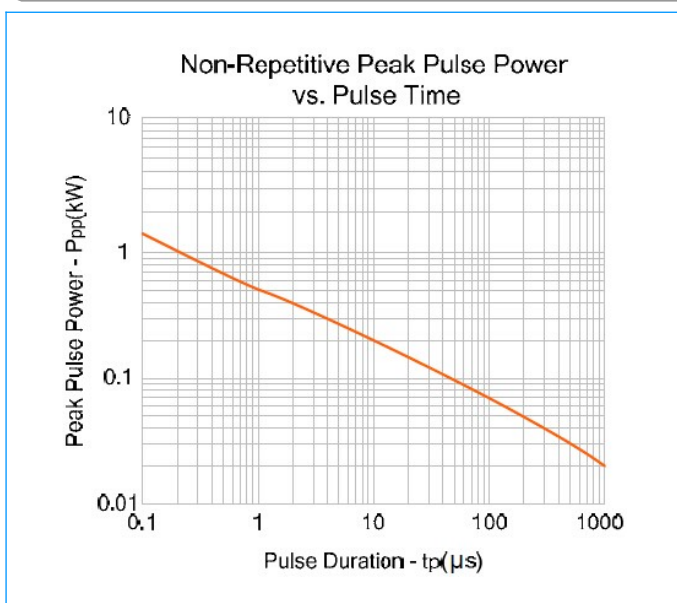

# 4-Channel Low Capacitance ESD Protection Diodes Array

## ESD05V06S-4L

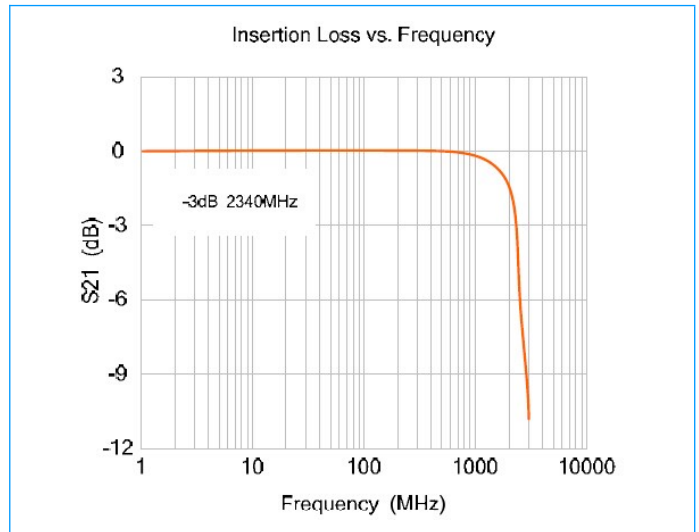
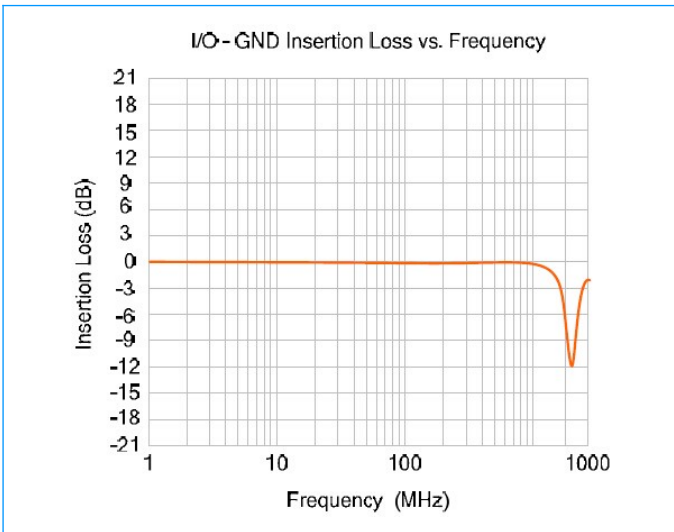
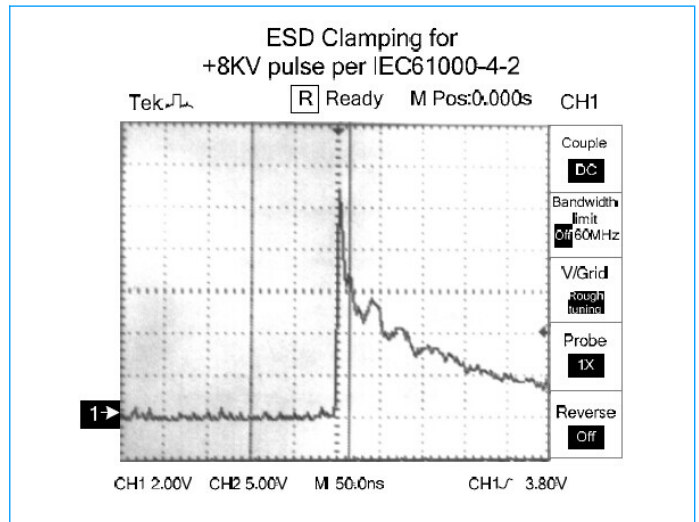
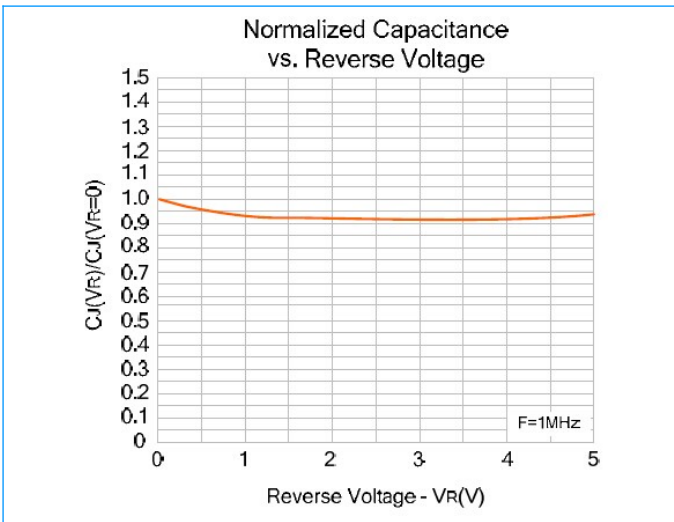
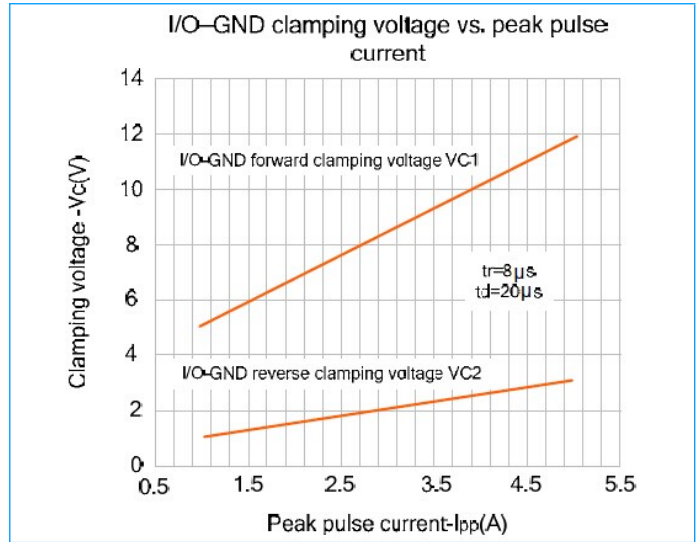
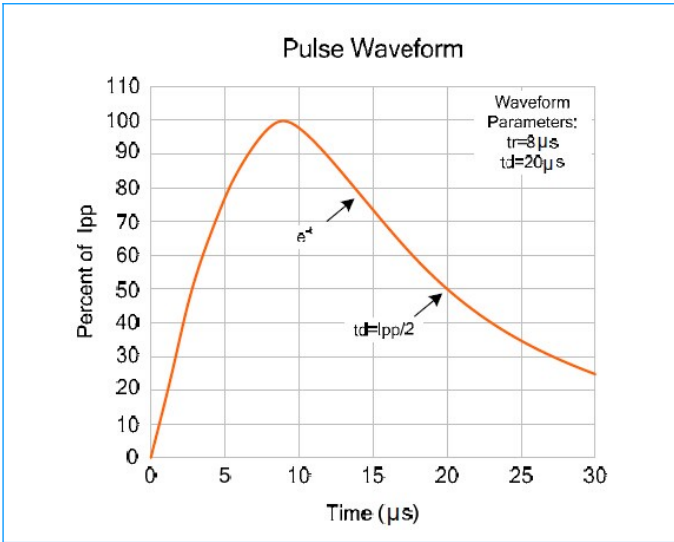

## 4-Channel Low Capacitance ESD Protection Diodes Array

### ESD05V06S-4L

#### SO-06 Package Outline & Dimensions

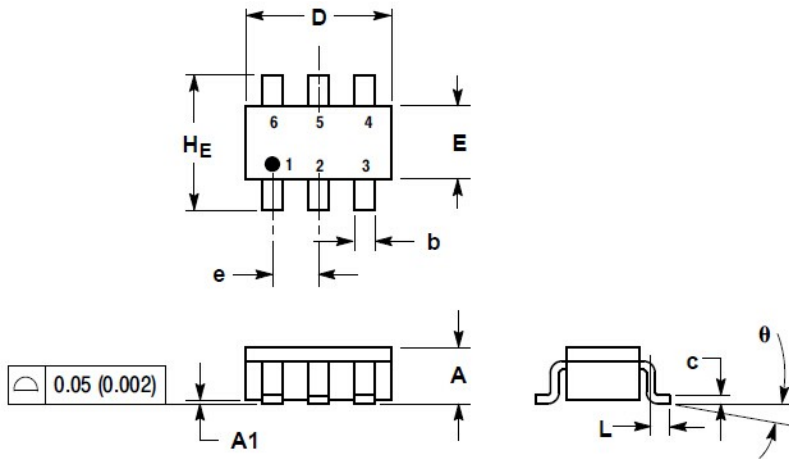

#### Notes:

1. Dimensioning and Tolerancing per ANSI Y14.5M, 1982.
2. Controlling Dimension: millimeter.
3. Maximum Lead Thickness Includes Lead Finish Thickness. Minimum Lead Thickness is the Minimum Thickness of Base Material.
4. Dimensions A and B do not include Mold Flash, Protrusions, or Gate Burrs.

Dim	Millimeters			Inches		
	Min	Nom	Max	Min	Nom	Max
A	0.90	1.00	1.10	0.035	0.039	0.043
A1	0.01	0.06	0.10	0.001	0.002	0.004
b	0.25	0.38	0.50	0.010	0.014	0.020
c	0.10	0.18	0.26	0.004	0.007	0.010
D	2.90	3.00	3.10	0.114	0.118	0.122
E	1.30	1.50	1.70	0.051	0.059	0.067
e	0.85	0.95	1.05	0.034	0.037	0.041
L	0.20	0.40	0.60	0.008	0.016	0.024
HE	2.50	2.75	3.00	0.099	0.108	0.118
θ	0°	-	10°	0°	-	10°

#### Soldering Footprint

