

DETAILS

Product Number	CS14143_STRADA-IP-2X6-T3
Family	Strada
Type	Assembly
Color	clear
Diameter	71,4x173 mm
Height	8,5 mm
Style	rectang
Optic Material	PMMA
Holder Material	
Fastening	screw
Status	production ready
ROHS Compliant	Yes
Date Updated	29/05/2017



OPTICAL PROPERTIES

LED	Viewing	Light	Effi-	cd/lm	Connector
	Angle	Beam	ciency		
SMD 5050	Asymmetric deg	Asymmetric	94 %	0.520	-
XT-E	Asymmetric deg	Asymmetric	94 %	0.600	-
XP-G2	Asymmetric deg	Asymmetric	94 %	0.600	-
XP-L	Asymmetric deg	Asymmetric	94 %	0.580	-
XHP35 HD	sim: Asymmetric	Asymmetric	sim: 88 %	sim: 0.500	-
XHP35 HI	sim: Asymmetric	Asymmetric	sim: 90 %	sim: 0.520	-
XP-G3	sim: Asymmetric	Asymmetric	sim: 88 %	sim: 0.550	-
XP-G3	Asymmetric deg	Asymmetric	94 %	0.600	-
XP-L2	Asymmetric deg	Asymmetric	94 %	0.530	-
H35C1 (LEMWA33)	asymmetric deg	Asymmetric	94 %	0.570	-
LUXEON Z ES	Asymmetric deg	Asymmetric	94 %	0.780	-
LUXEON XR-TX (L2T0-xyy012M)	Asymmetric deg	Asymmetric	94 %	0.650	-
LUXEON 5050	sim: Asymmetric	Asymmetric	sim: 91 %	sim: 0.510	-
NVSxx19B/NVSxx19C	Asymmetric deg	Asymmetric	94 %	0.640	-
Duris S8	sim: Asymmetric	Asymmetric	sim: 90 %	sim: 0.570	-
Duris P8	sim: Asymmetric	Asymmetric	sim: 90 %	sim: 0.630	-
Fortimo FastFlex LED board 2x6 DP G4	Asymmetric deg	Asymmetric	94 %	0.600	-
Fortimo FastFlex LED board 2x6 DPX G4	Asymmetric deg	Asymmetric	94 %	0.600	-
LH351Z	asymmetric deg	Asymmetric	94 %	0.580	-
LH351B	sim: Asym	Asymmetric	sim: 93 %	sim: 0.520	-
Acrich MJT 4040	sim: Asymmetric	Asymmetric	-	-	-
Z5M1/Z5M2	sim: Asymmetric	Asymmetric	sim: 91 %	sim: 0.760	-
Z8Y22P	Asymmetric deg	Asymmetric	94 %	0.630	-
TL1L3	sim: Asymmetric	Asymmetric	sim: 86 %	-	-
TL1L2	sim: Asymmetric	Asymmetric	sim: 88 %	-	-



PRODUCT DATASHEET
Strada series
last update 29/5/2017

OPTICAL PROPERTIES

LED	Viewing Angle	Light Beam	Effi- ciency	cd/lm	Connector
-----	------------------	---------------	-----------------	-------	-----------

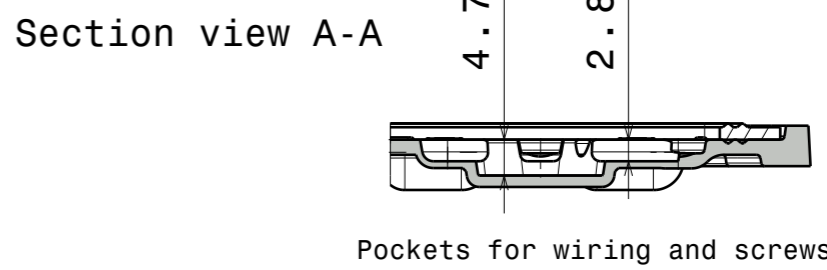
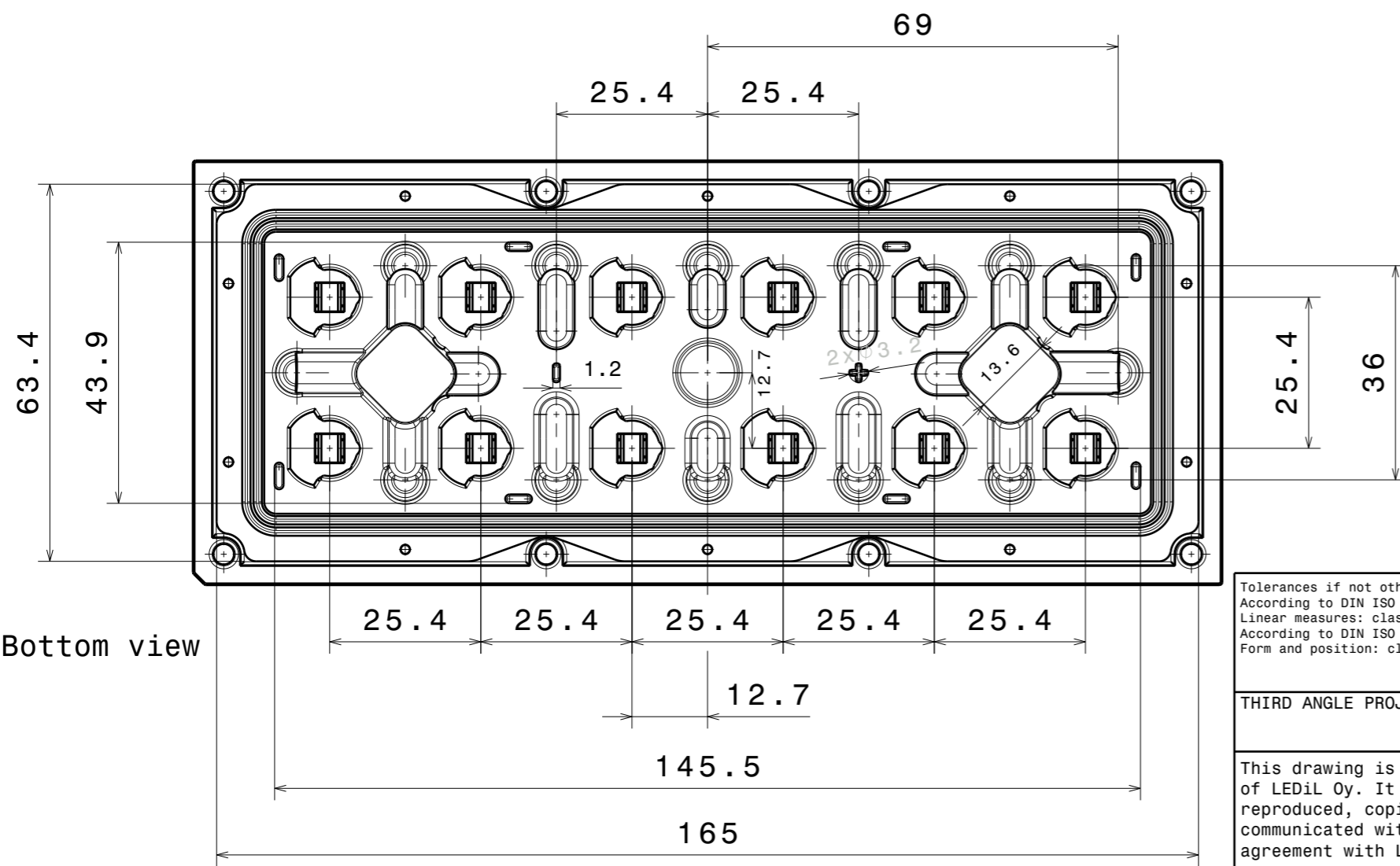
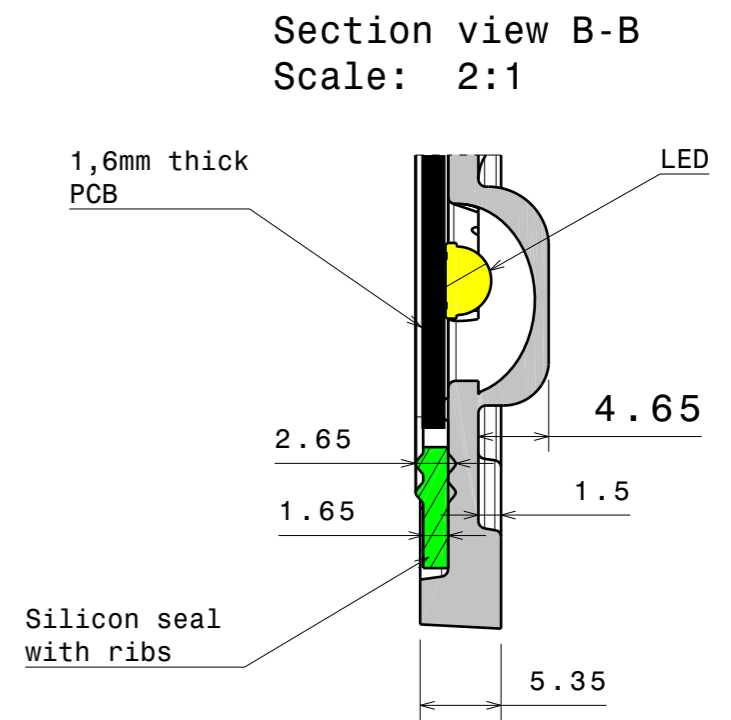
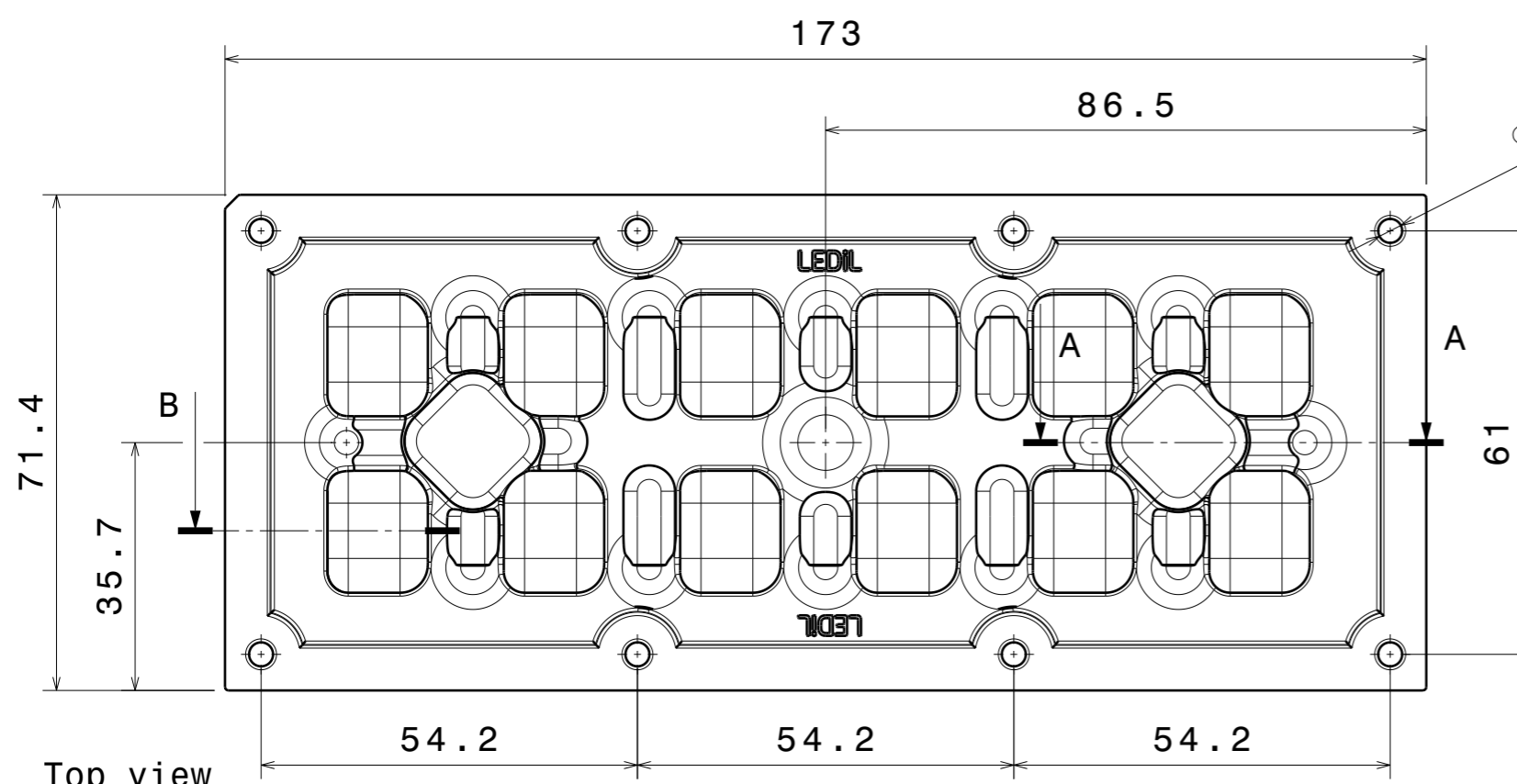

INDEX	PART NO	DESCRIPTION	MATERIAL	COLOUR
1	C14018	2X6-SEAL25	Silicone	white
2	C13364	STRADA-IP-2X6-T3	PMMA	clear

Tolerances if not otherwise shown
According to DIN ISO 2768-1
Linear measures: class M
According to DIN ISO 2768-2
Form and position: class L

LEDiL Ledil Oy
Salorankatu 10
FIN 24240 SALO
Finland

THIRD ANGLE PROJECTION:

DRAWING TITLE
CS14143_STRADA-IP-2X6-T3

This drawing is the property of LEDiL Oy. It may not be reproduced, copied or communicated without a written agreement with LEDiL Oy.

SIZE **A3** PART NUMBER **CS14143**

SCALE 1:1 WEIGHT 58,36 g SHEET 1/2

Luminaire: LEDiL Oy CS14143_STRADA-IP-2X6-T3_(Bridgelux_5050_Gen2)

Lamps: 1 x Bridgelux_5050_Gen2_2x6_(BXEP-57C-435-09B)_4268.87lm@250mA_CCT=5700K_P=24.6757W_I=0.25A

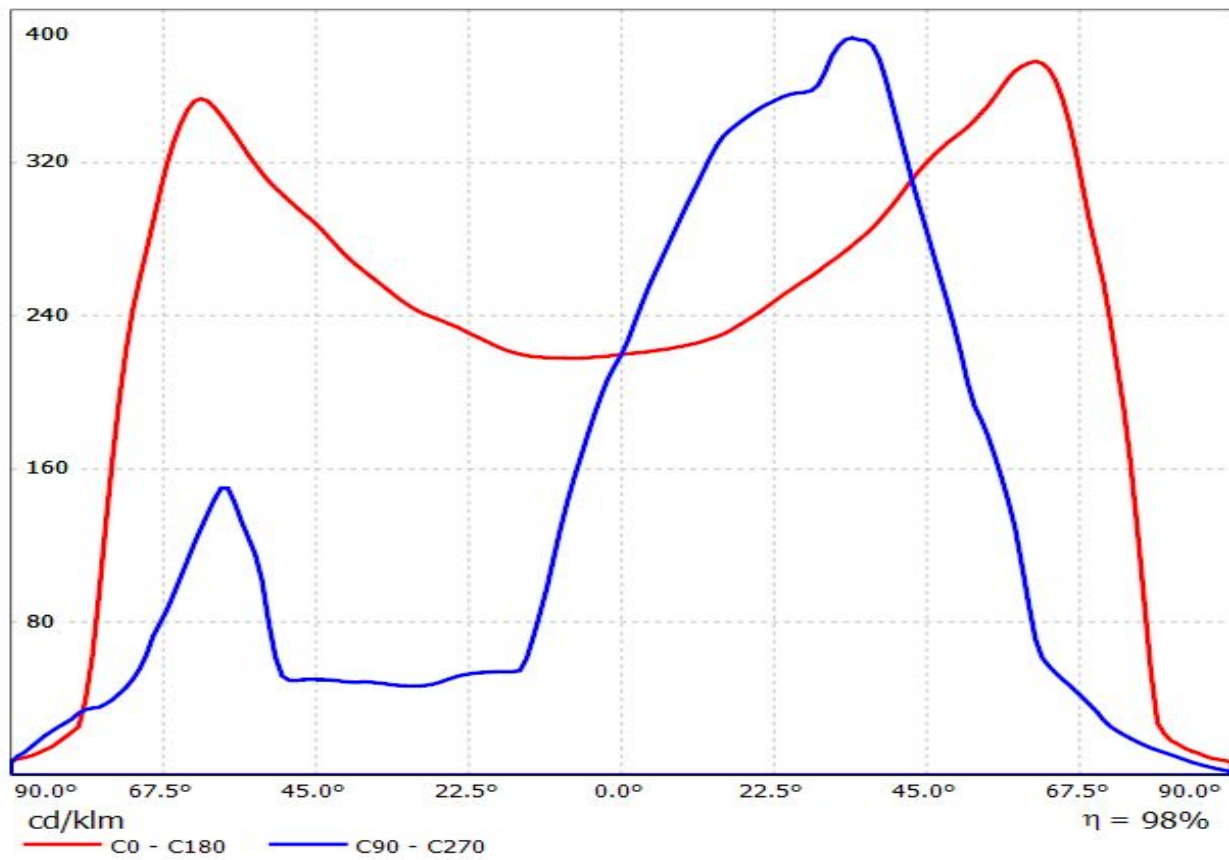

Luminaire: LEDiL Oy CS14143_STRADA-IP-2X6-T3

Lamps: 1 x CREE_XT-E_6x2_(XTEAWT-00-0000-000000HE4)_1253.92lm@250mA_P=8.86265W_I=249.8mA

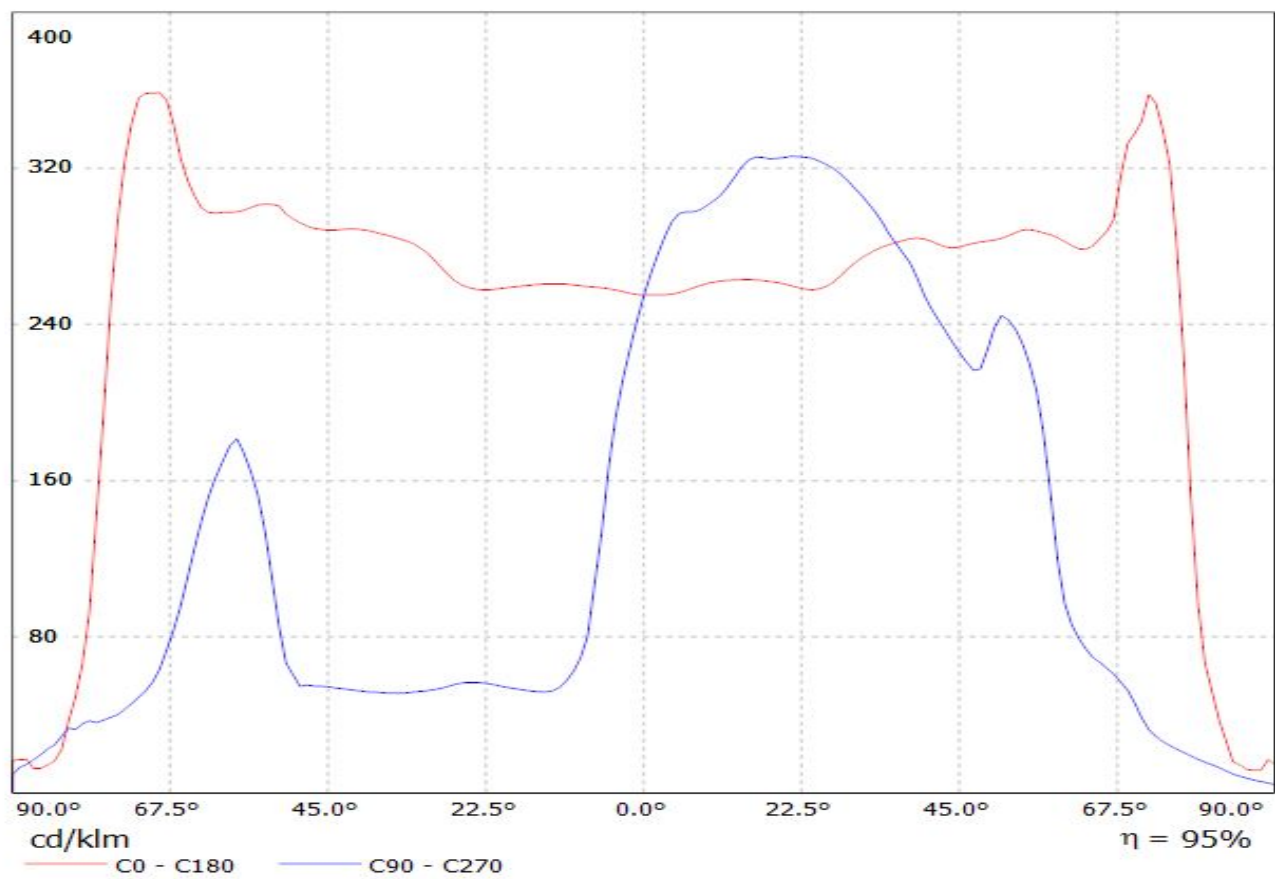

Luminaire: LEDiL Oy CS14143_STRADA-IP-2X6-T3_(XP-G2) Eff.94.1%
Lamps: 1 x CREE_XP-G2_1277.8lm@250mA_P=8.54291W_I=249.8mA

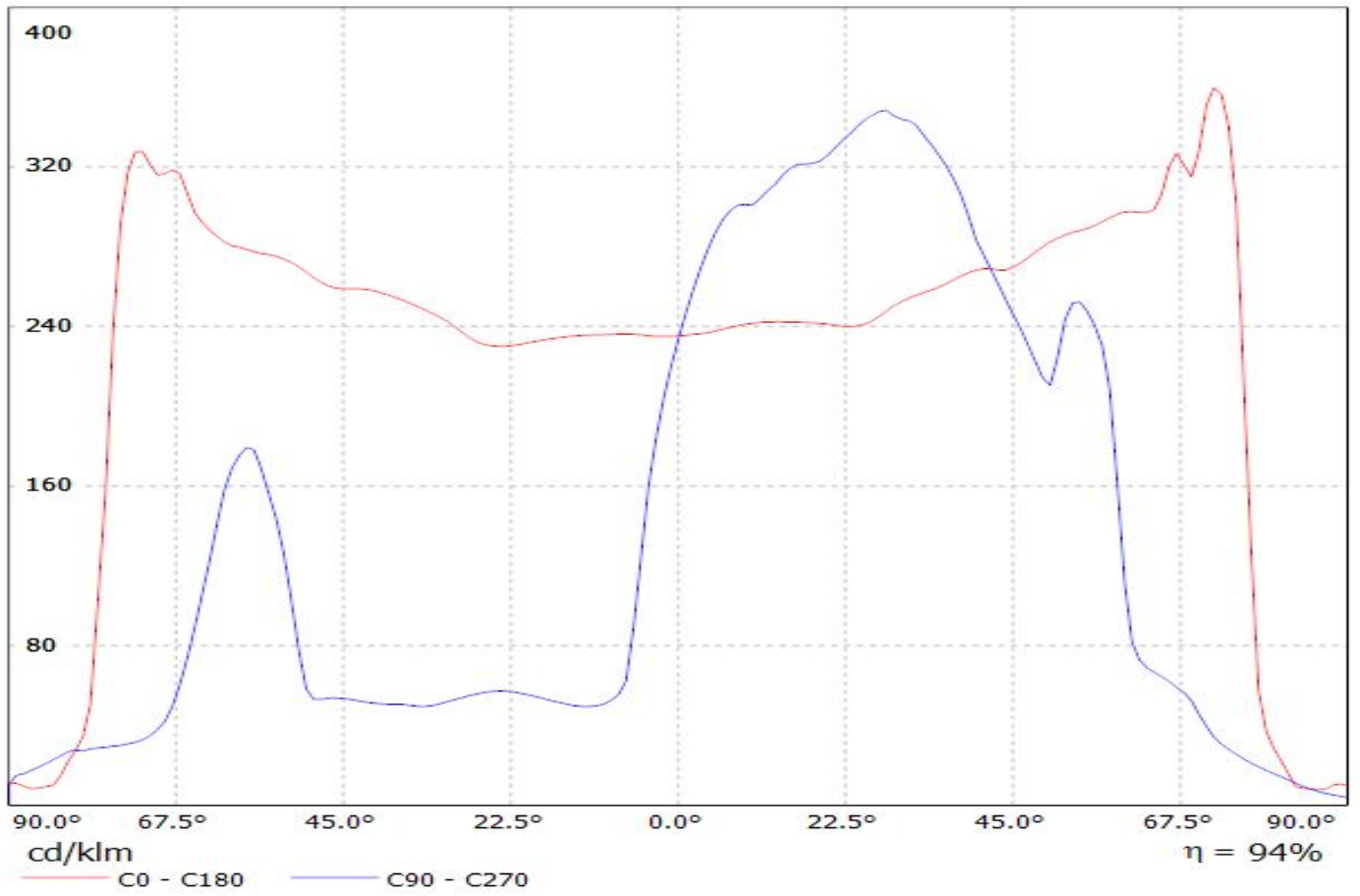

Luminaire: LEDiL Oy CS14143_STRADA-IP-2X6-T3_(XP-L) Eff.95.3%
Lamps: 1 x CREE_XP-L_2x6_(XPLAWT-0-7A3-U50-0H-0001)
_1270.8lm@250mA_P=8.22317W_I=249.8mA

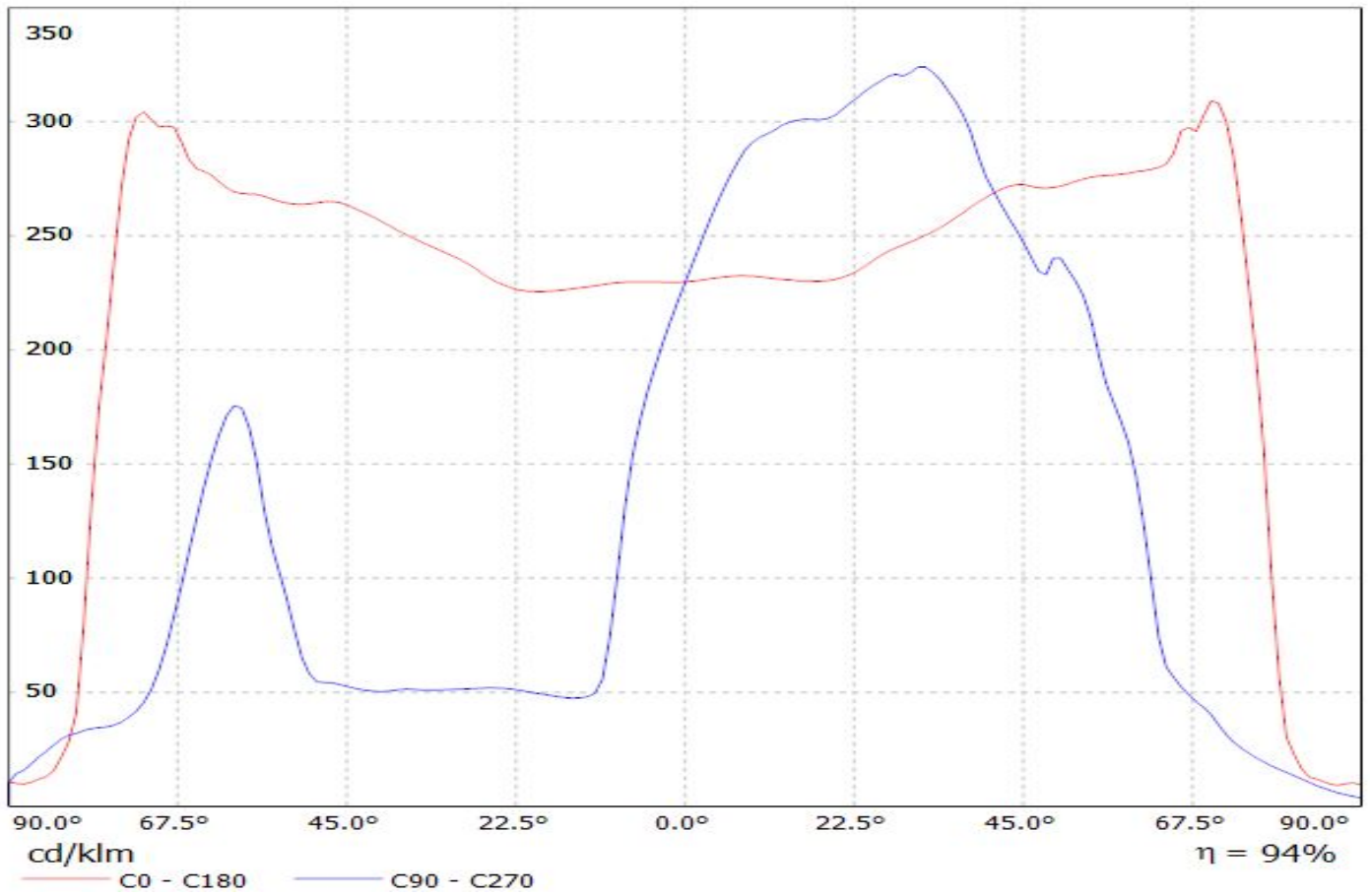

Luminaire: Ledil Oy CS14143_STRADA-IP-2X6-T3_(XP-G3)_SIMULATED
Lamps: 1 x Cree XP-G3

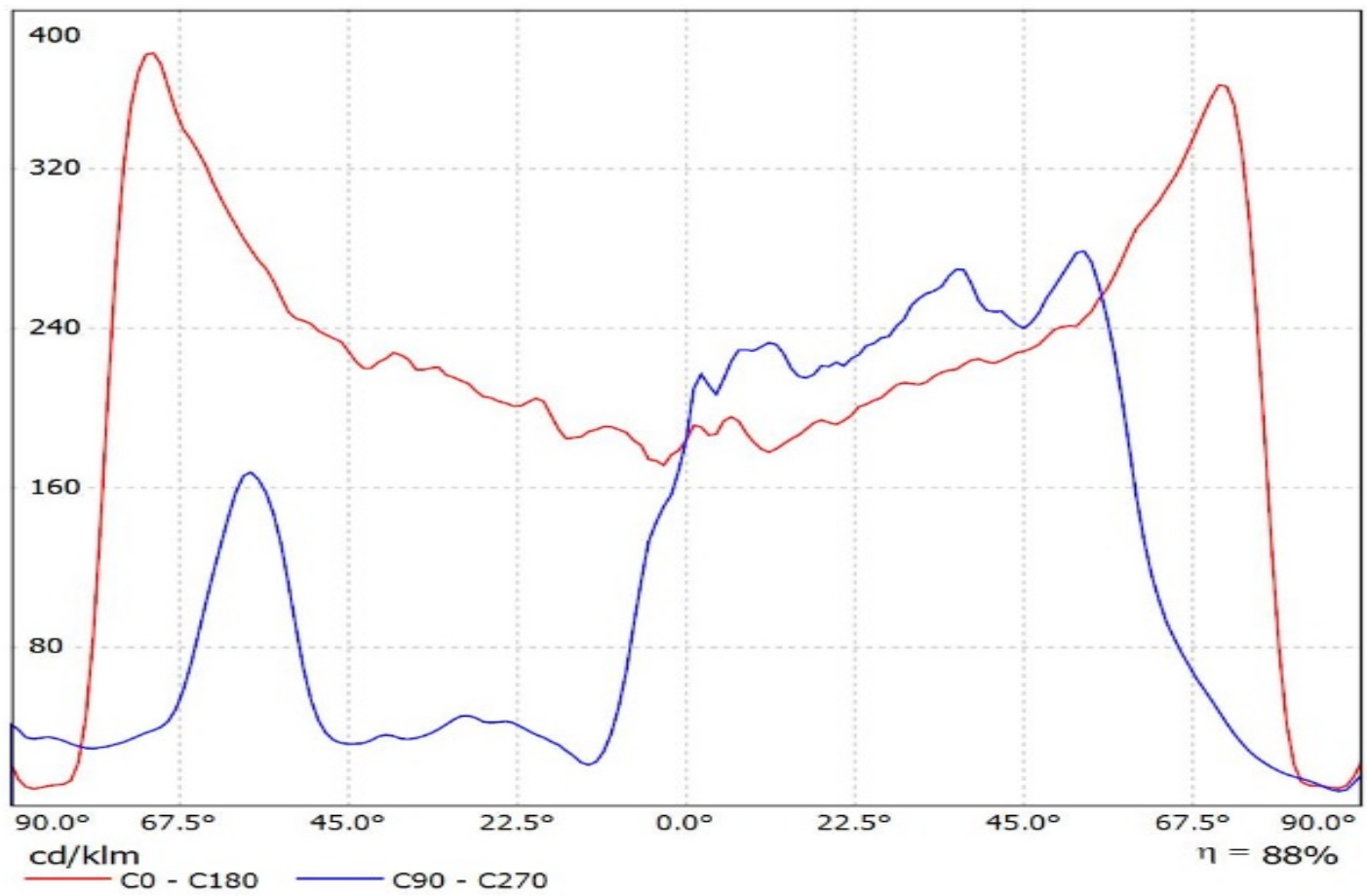

Luminaire: Ledil CS14143_STRADA-IP-2x6-T3_(XP-G3)

Lamps: 1 x Cree_XP-G3_6x2_(XPGDWT-B1-6C1-S3-0-01)_1521.26lm@250mA_P=8.253W_I=0.25A

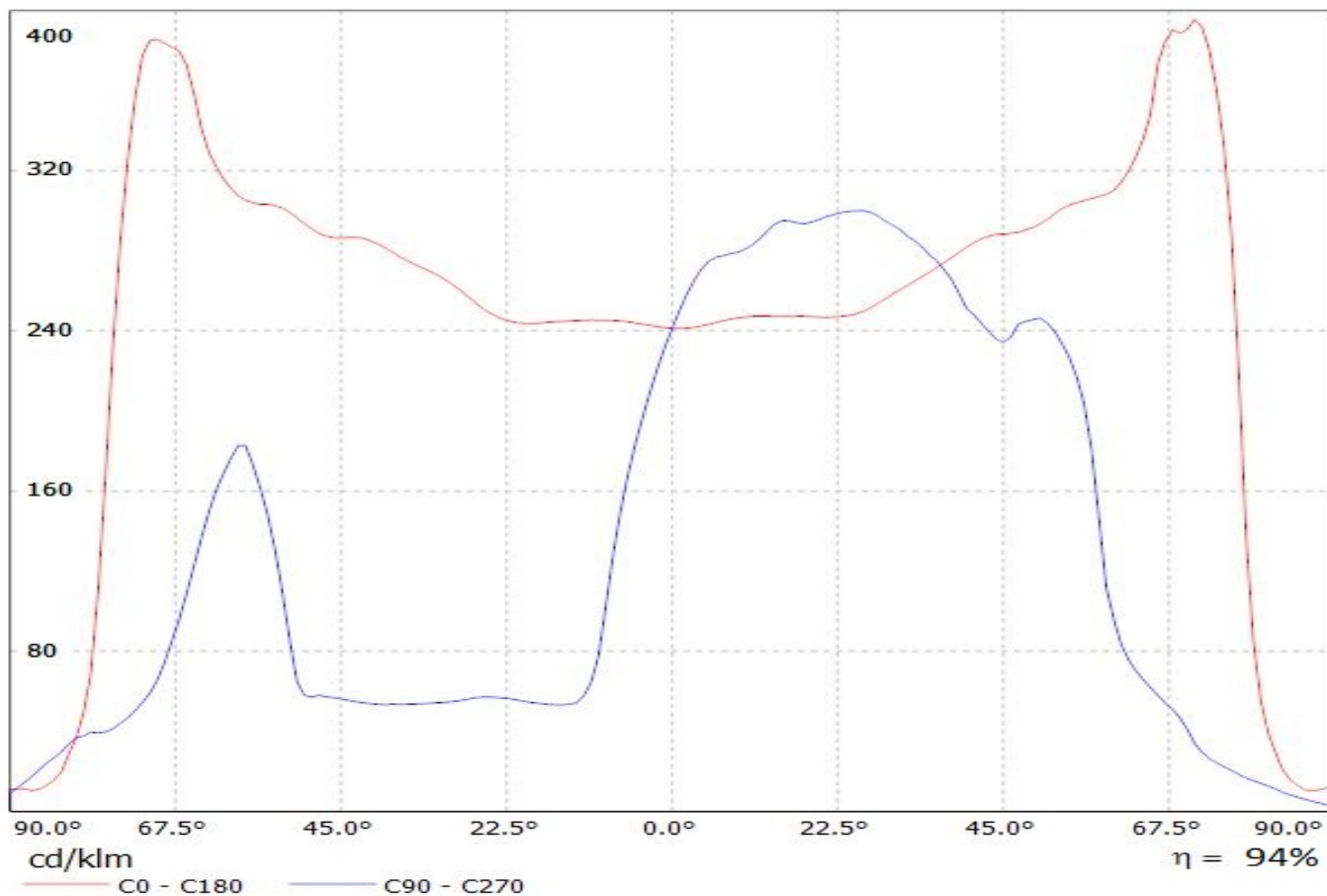

Luminaire: Ledil CS14143_STRADA-IP-2X6-T3_(XP-L2)
Lamps: 1 x Cree_XP-L2x12_(XPGBWT-H1-3B0-R5-0-01)
1666.32lm@250mA_CCT=5000_P=8.239W_I=0.25A

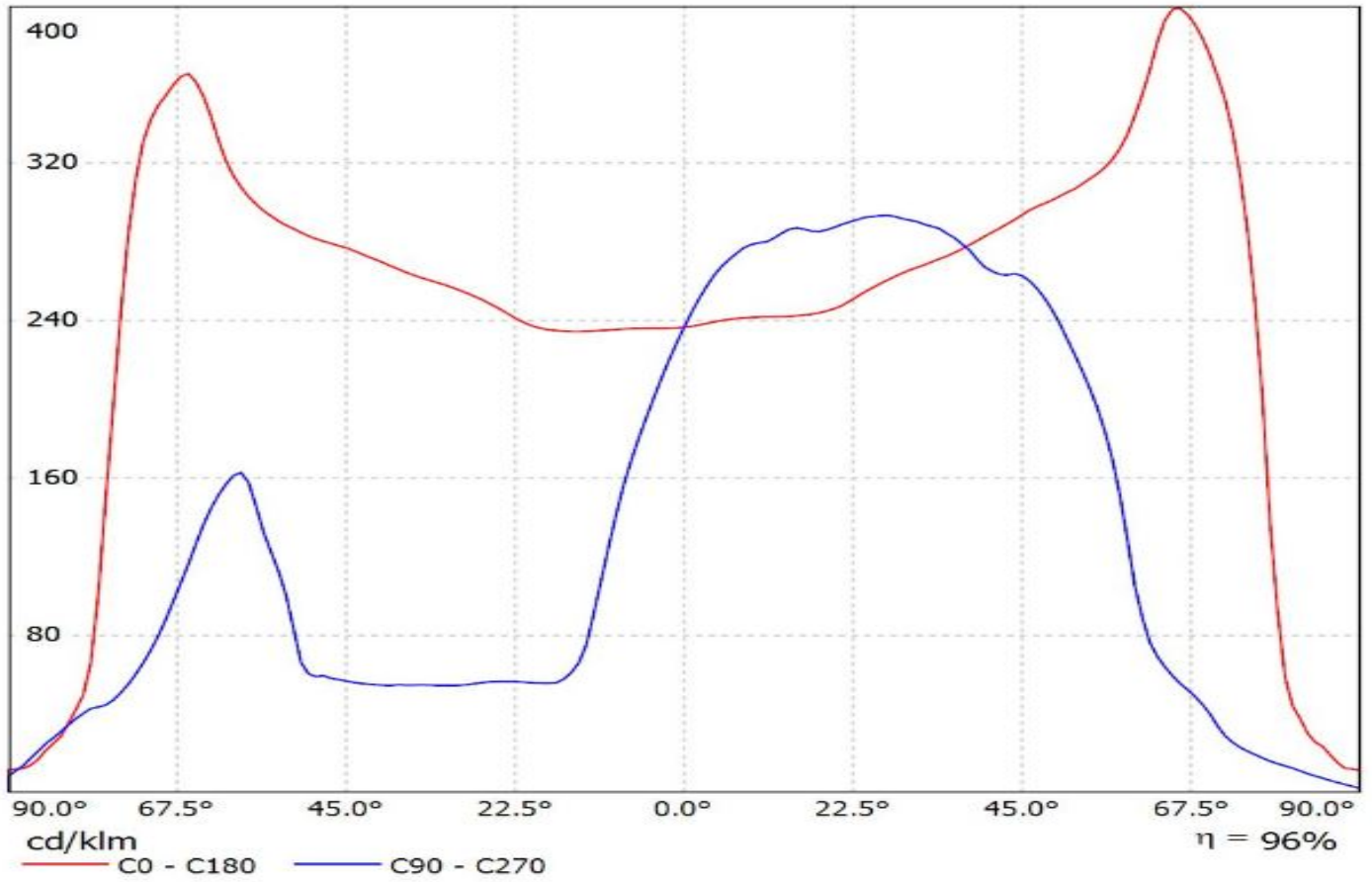

Luminaire: LEDiL Oy CS14143_STRADA-IP-2X6-T3_(LG_3535_H35C1)
Lamps: 1 x LG_3535_H35C1_2x6_1360.63lm@250mA_P=8.55408W_η=249.9mA

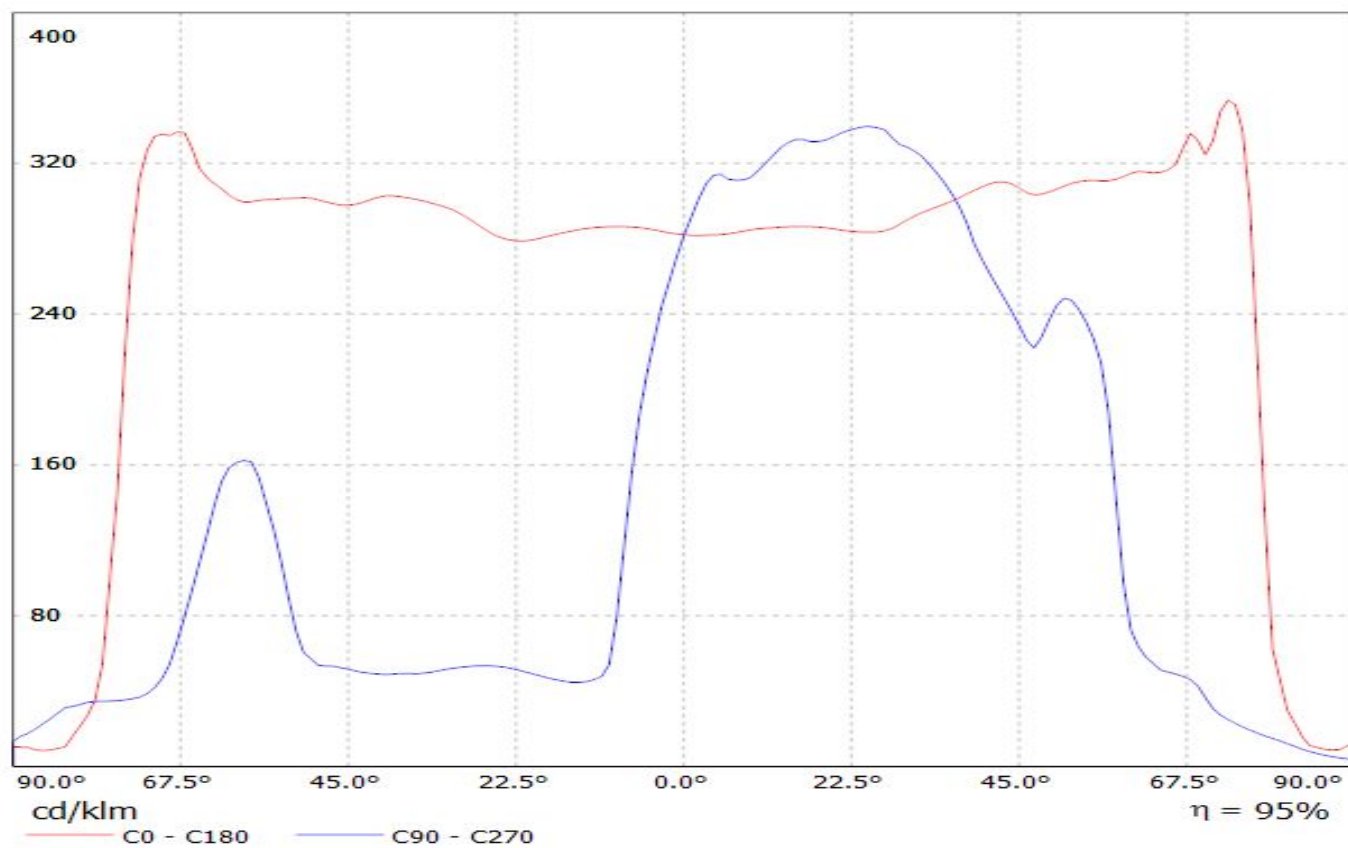

Luminaire: LEDiL Oy CS14143_STRADA-IP-2X6-T3_(LUXEON_Z_ES) Eff.94.0%
Lamps: 1 x LUXEON_Z_ES_984.3lm@250mA_P=8.31159W_I=249.8mA

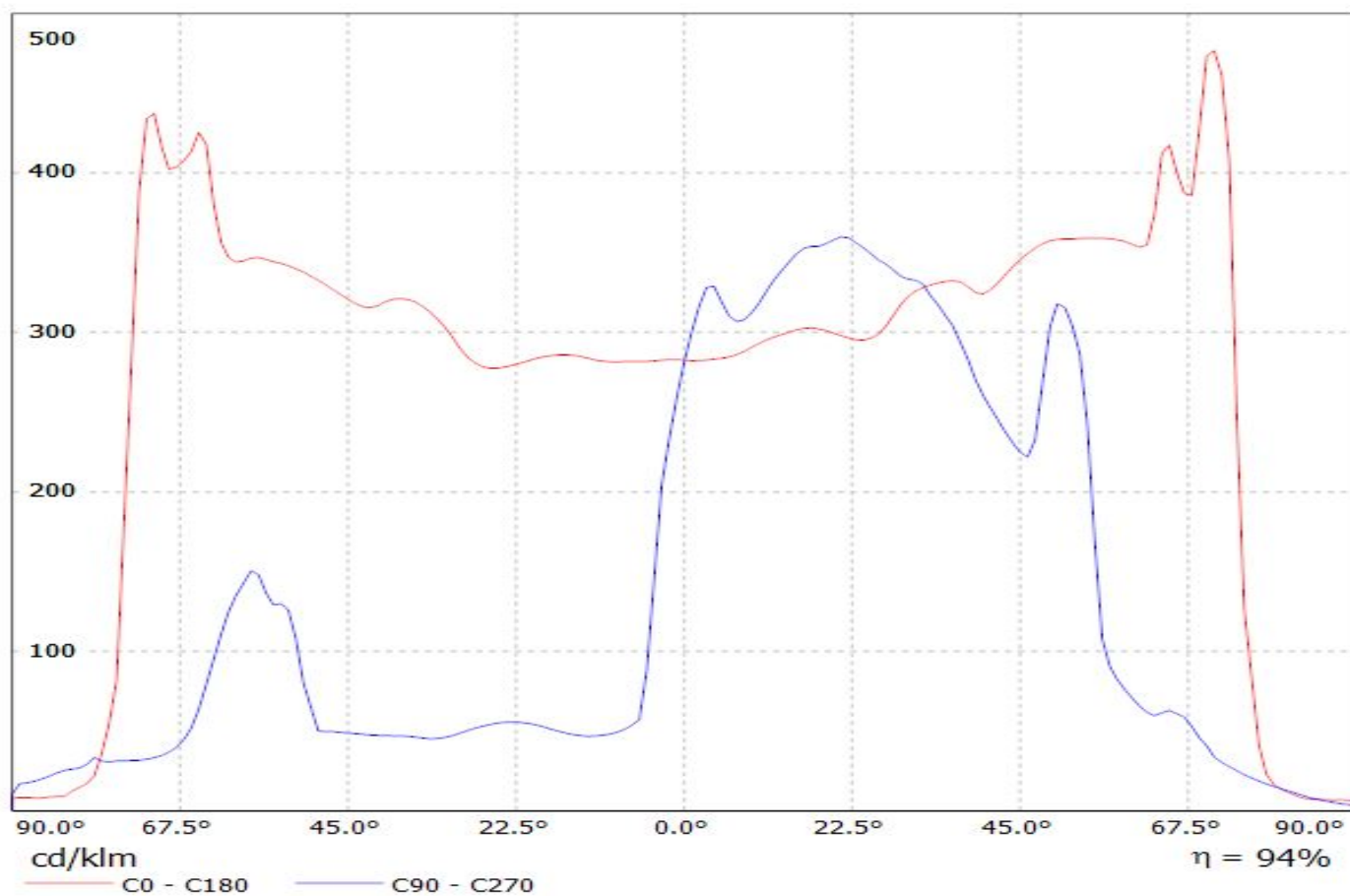

Luminaire: Ledil CS14143_STRADA-IP-2X6-T3_(XR-TX)
Lamps: 1 x Luxeon_XR-TX_1377.67lm@250mA_P=8.3973W_I=0.250A

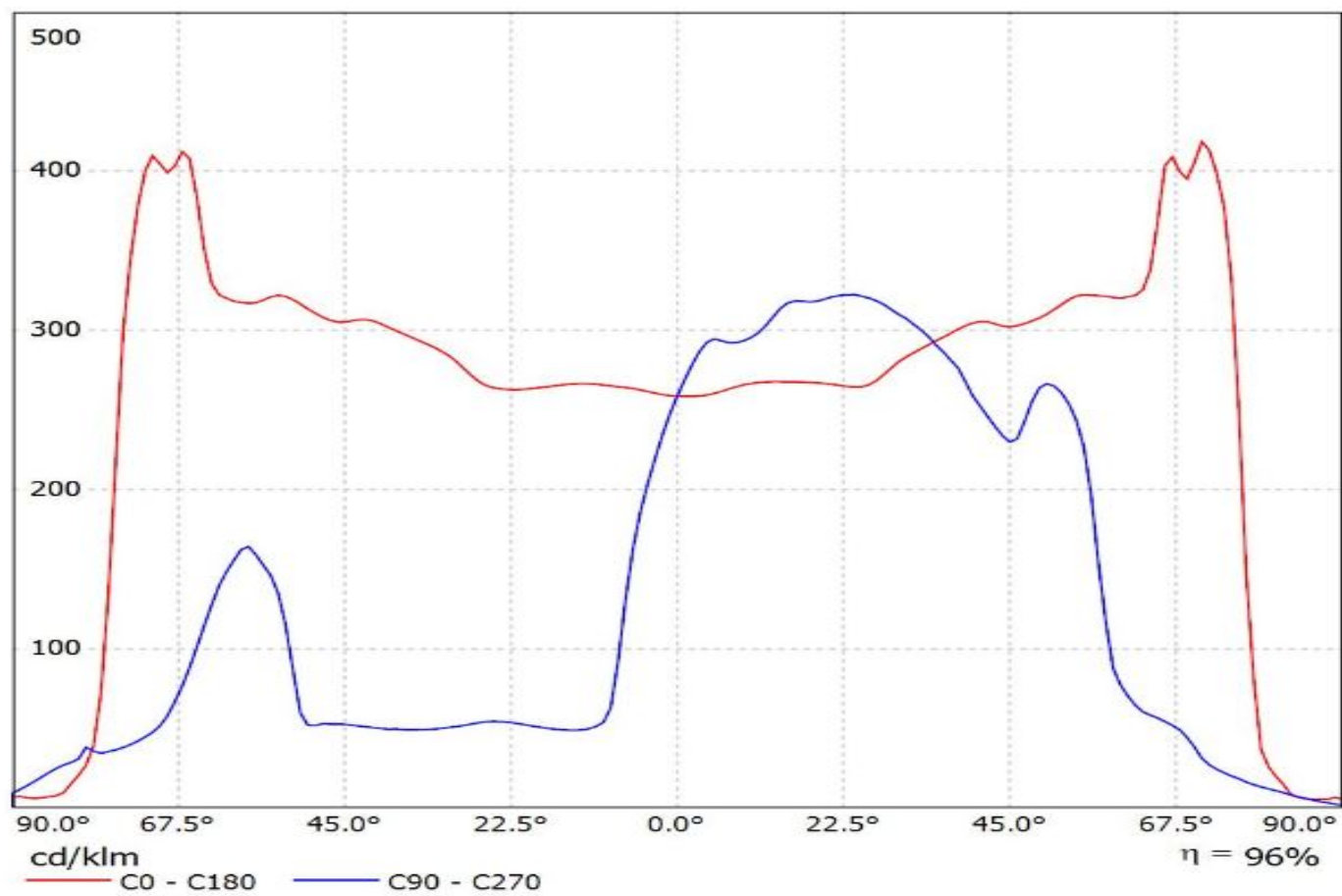

Luminaire: Ledil Oy CS14143_STRADA-IP-2X6-T3_LUXEON-5050_SIMULATED
Lamps: 1 x Lumileds Luxeon 5050

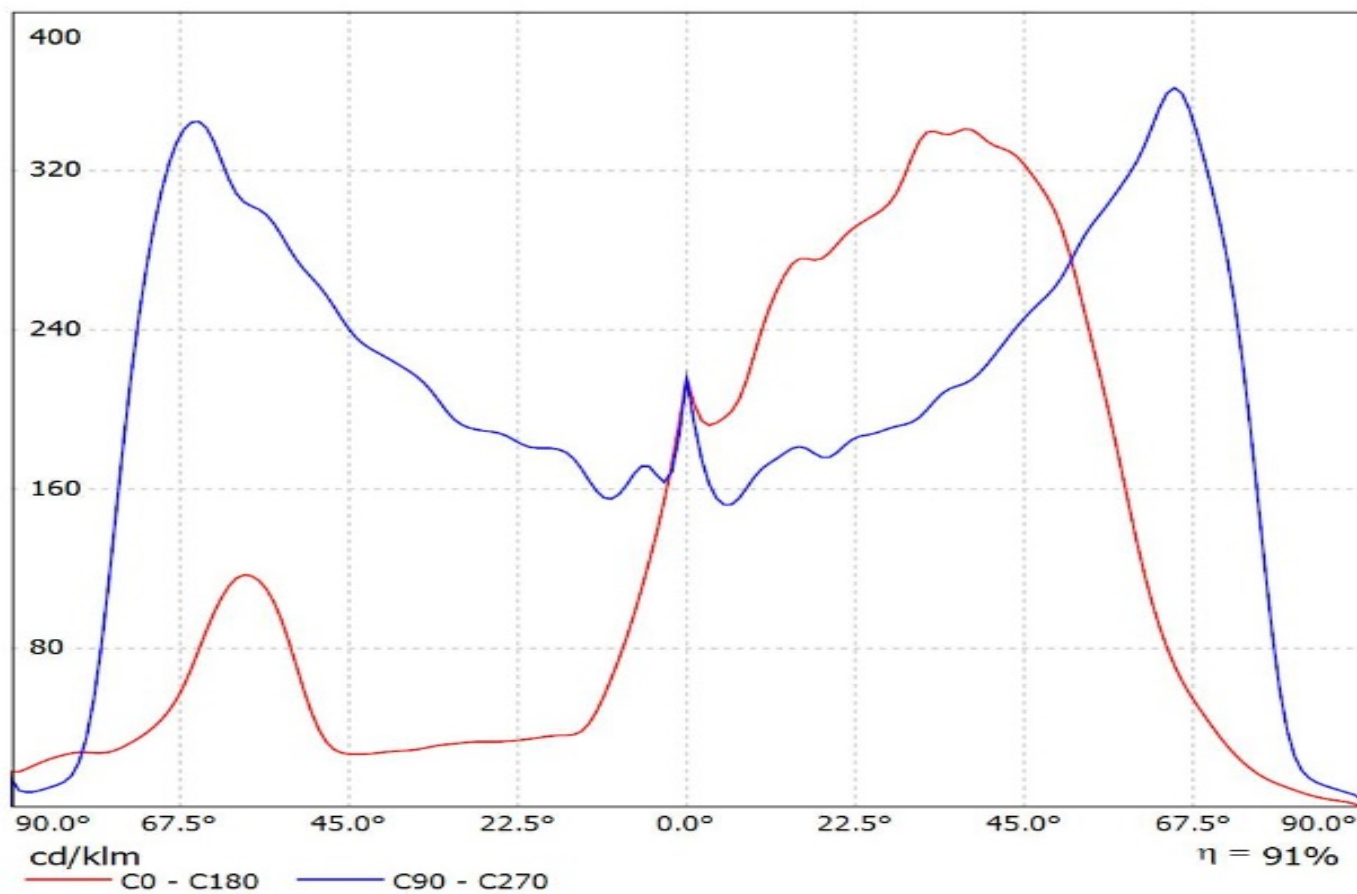

Luminaire: Ledil CS14143_STRADA-IP-2X6-T3_(NVSL219CT)

Lamps: 1 x Nichia_NVSL219CT_2x6_1262.53lm@250mA_P=8.35825W_I=0.25A

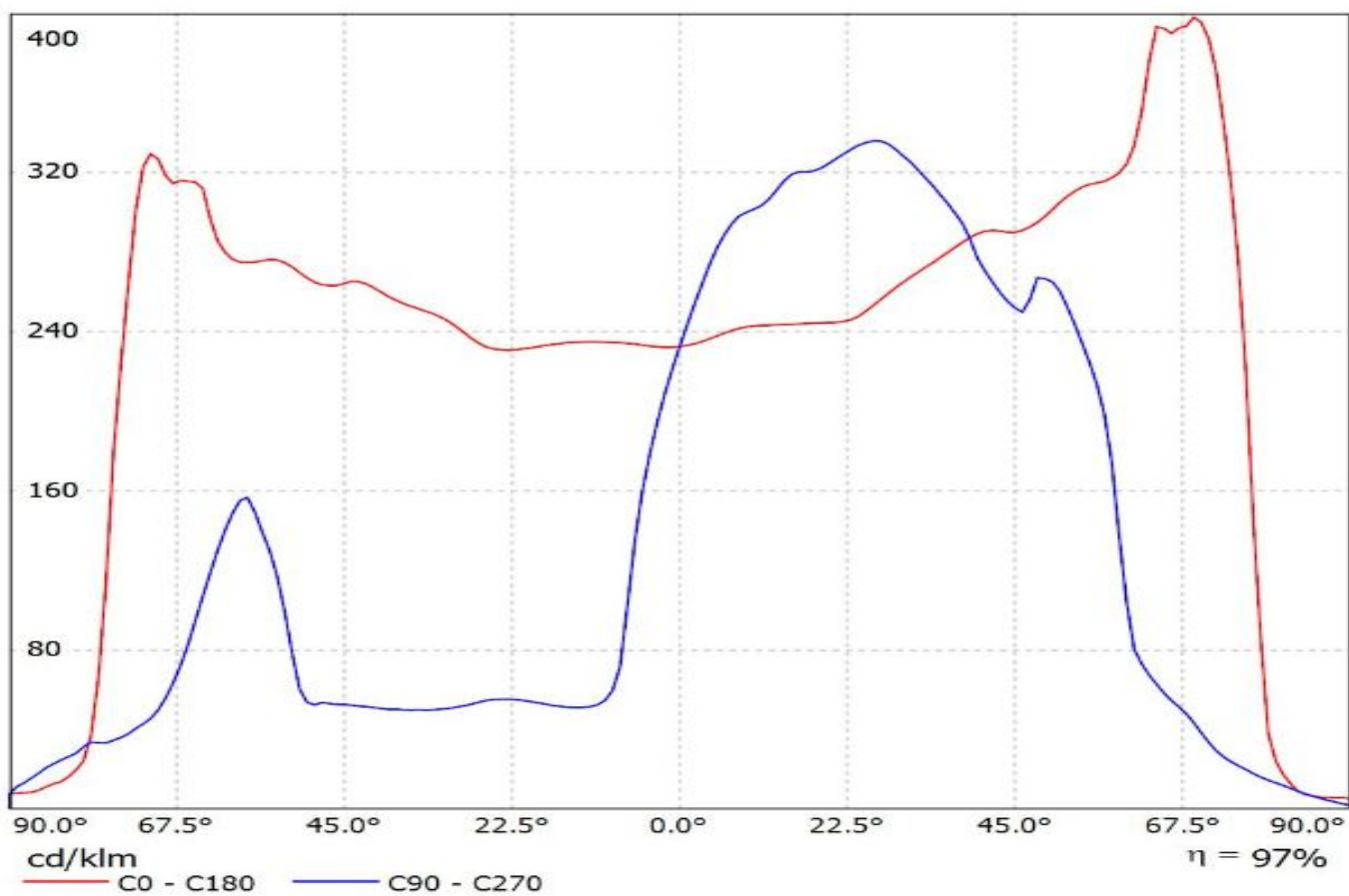

Luminaire: Ledil Oy CS14143_STRADA-IP-2X6-T3_(Duris_P8)_SIMULATED
Lamps: 1 x Osram Duris P8

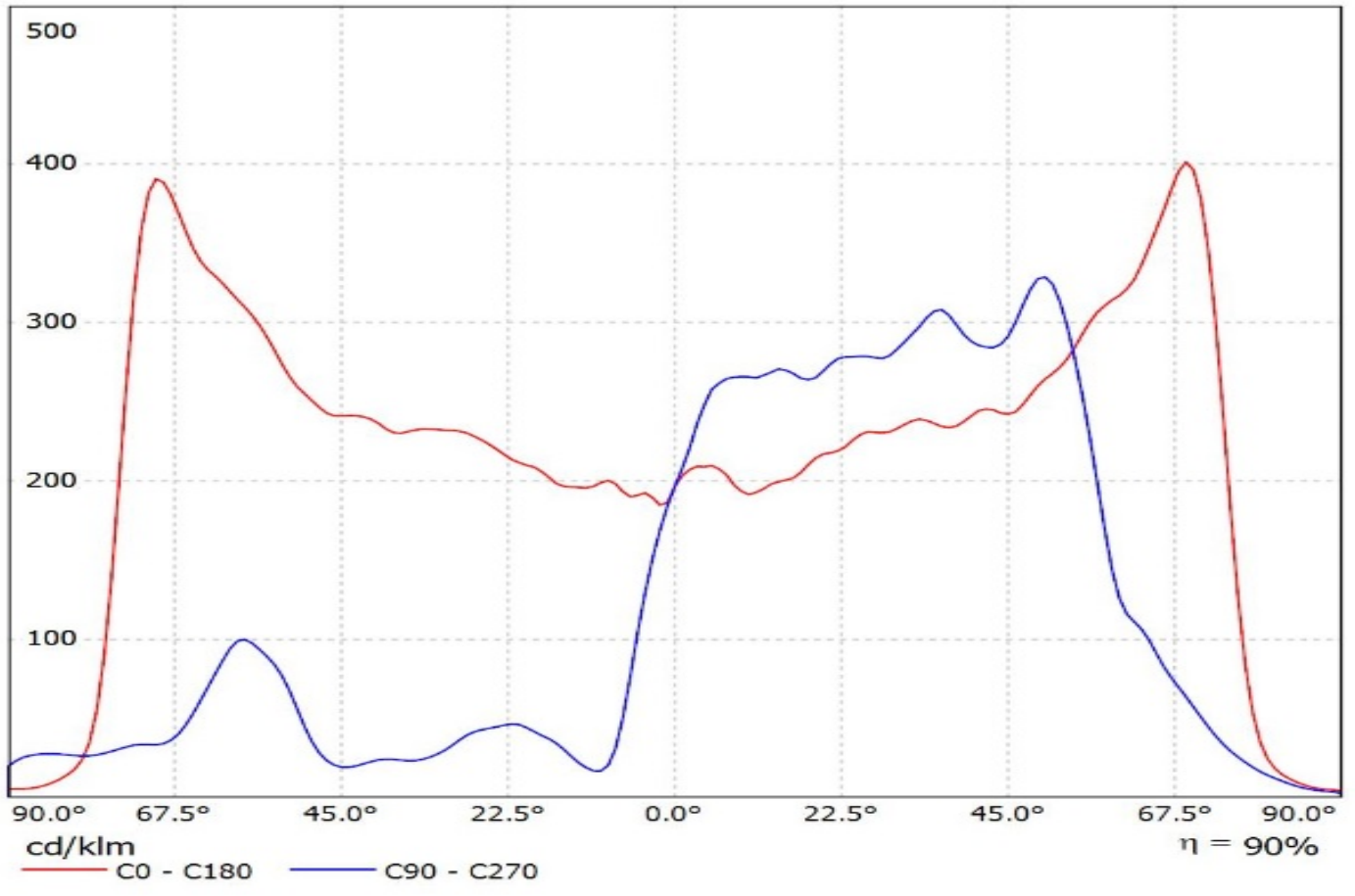

Luminaire: LEDiL Oy CS14143_STRADA-IP-2X6-T3_Fortimo FastFlex LED board 2x6 DP G4
Lamps: 1 x Fortimo FastFlex LED board 2x6 DP G4

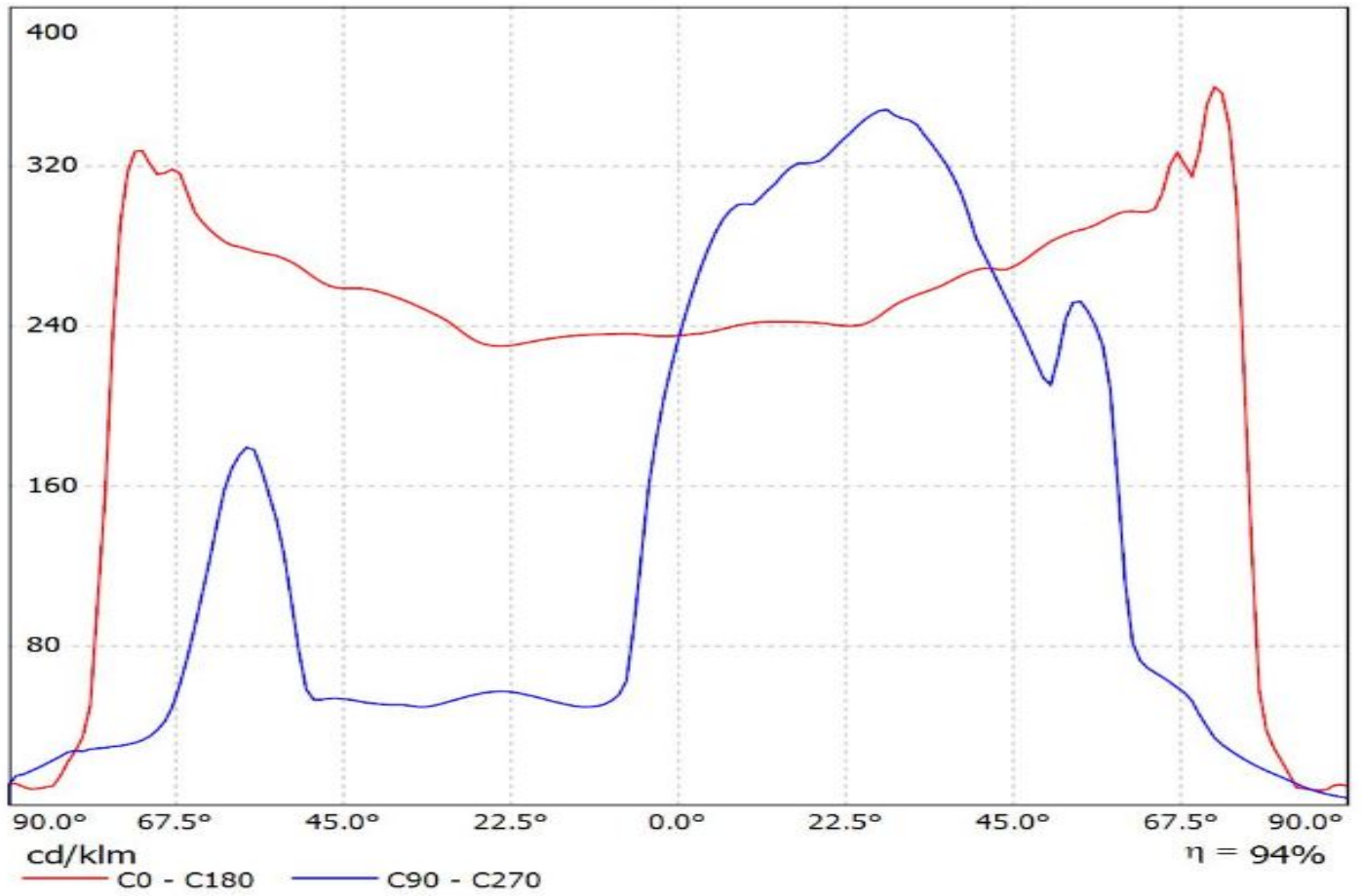

Luminaire: Ledil CS14143_STRADA-IP-2x6-T3_Fortimo FastFlex LED board 2x6 DPX G4
Lamps: 1 x Fortimo FastFlex LED board 2x6 DPX G4

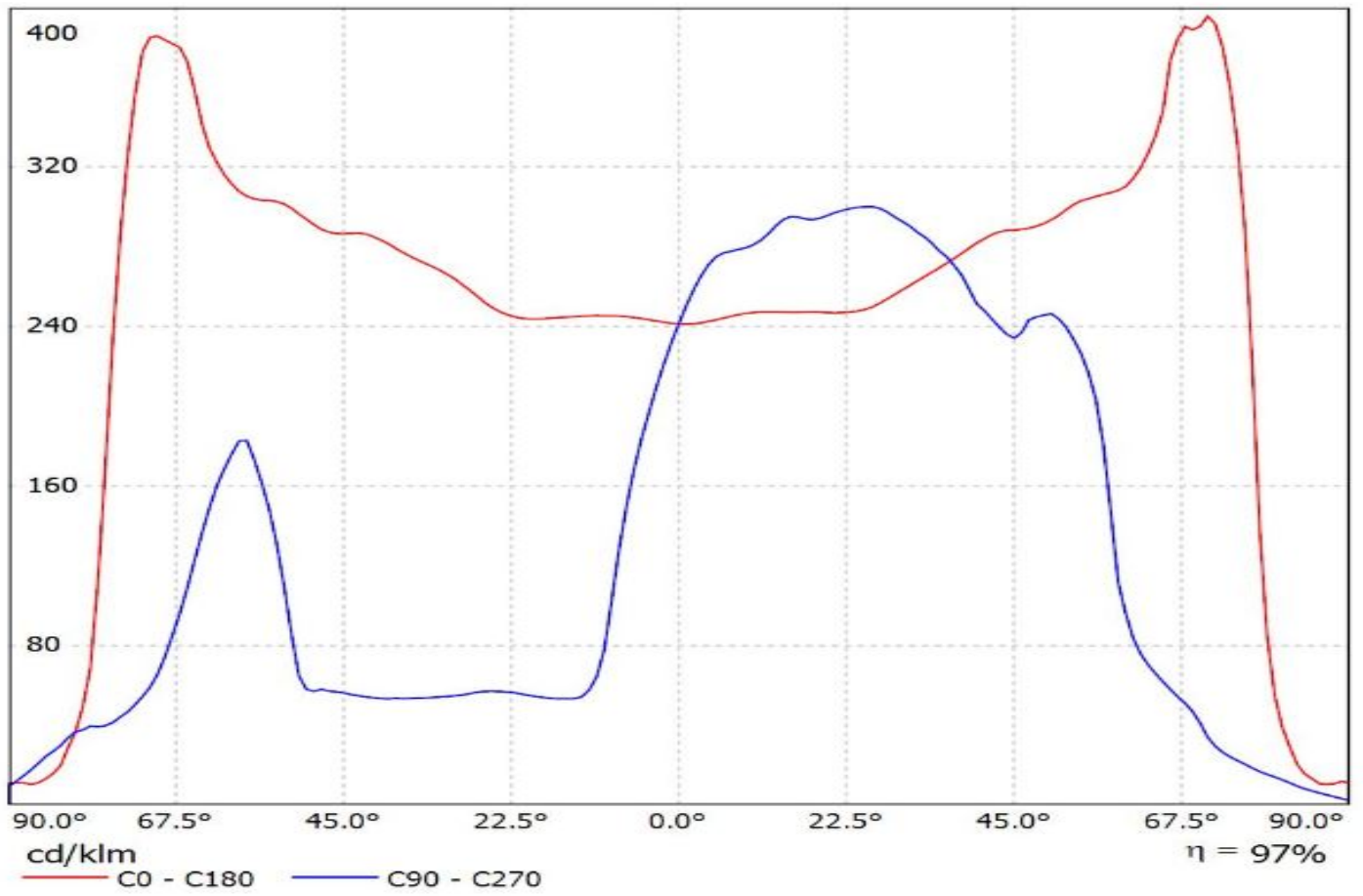

Luminaire: LEDiL Oy CS14143_STRADA-IP-2X6-T3_(LH351Z)

Lamps: 1 x SAMSUNG_LH351Z_2x6_960.75lm@250mA_P=8.67003W_I=249.9mA

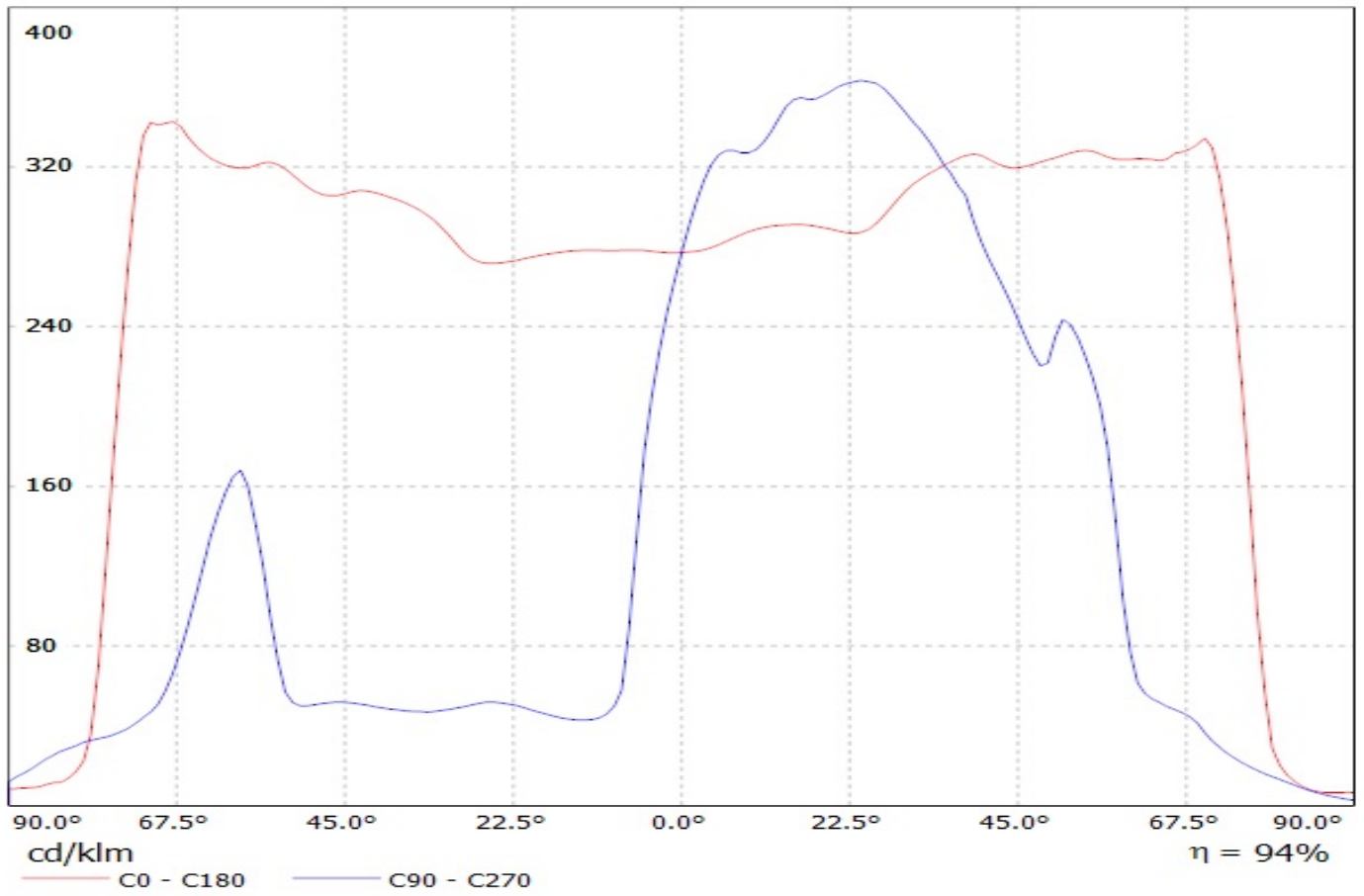

Luminaire: Ledil Oy CS14143_STRADA-IP-2X6-T3_(LH351B)_SIMULATED
Lamps: 1 x Samsubng LH351B

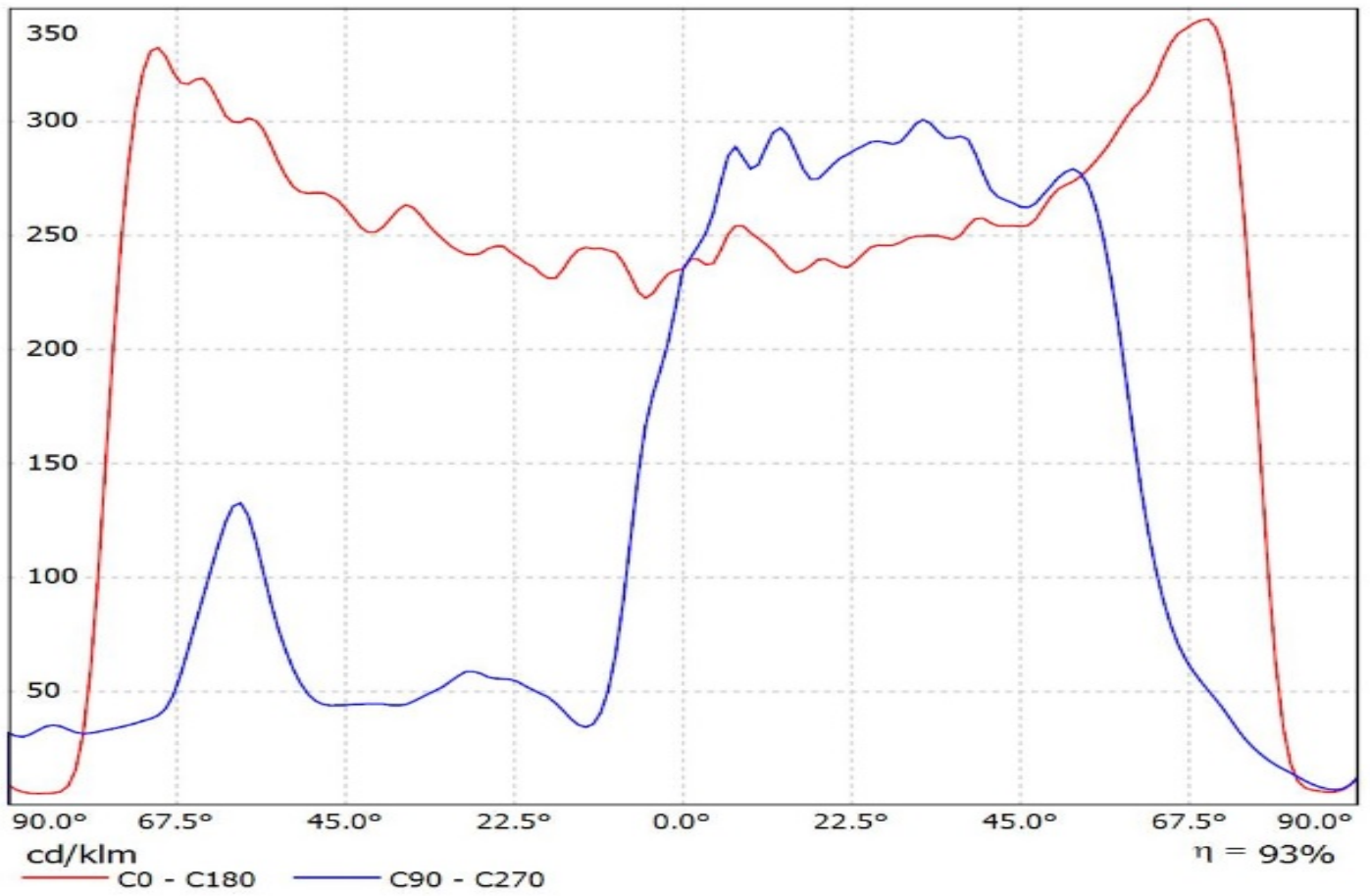

Luminaire: Ledil Oy CS14143_STRADA-IP-2X6-T3_(Z5M1)_SIMULATED
Lamps: 1 x Seoul Z5M1

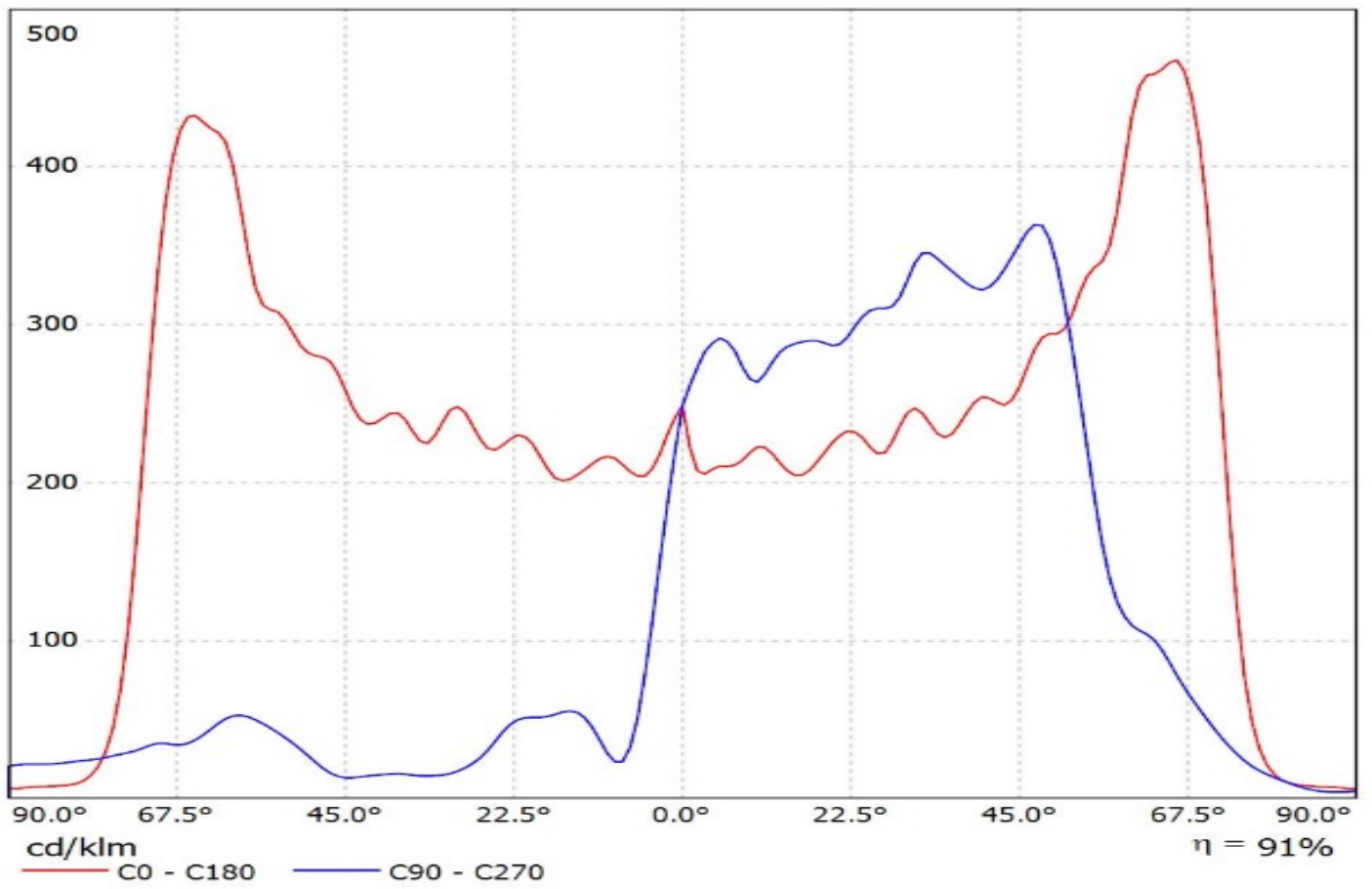

Luminaire: Ledil CS14143_STRADA-IP-2X6-T3_(Z8Y22_PLUS)

Lamps: 1 x Seoul_Z8Y22_PLUS_2X6_(SZ8-Y22-W0-C7P)1489.65lm@250mA_P=8.30675W_I=0.250A

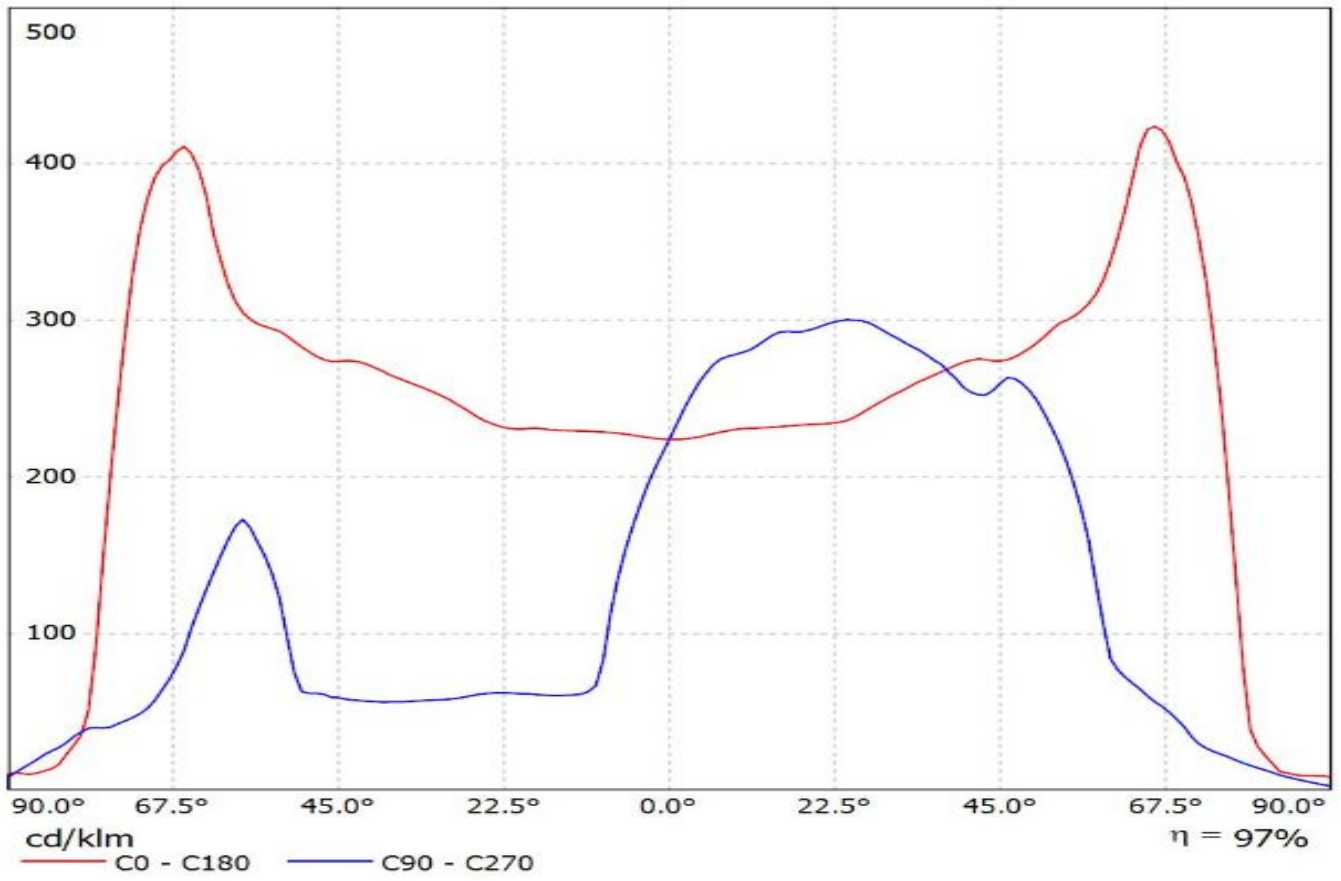

Luminaire: LEDiL Oy CS14143_STRADA-IP-2X6-T3_(Bridgelux_5050_Gen2)

Lamps: 1 x Bridgelux_5050_Gen2_2x6_(BXEP-57C-435-09B)_4268.87lm@250mA_CCT=5700K_P=24.6757W_I=0.25A

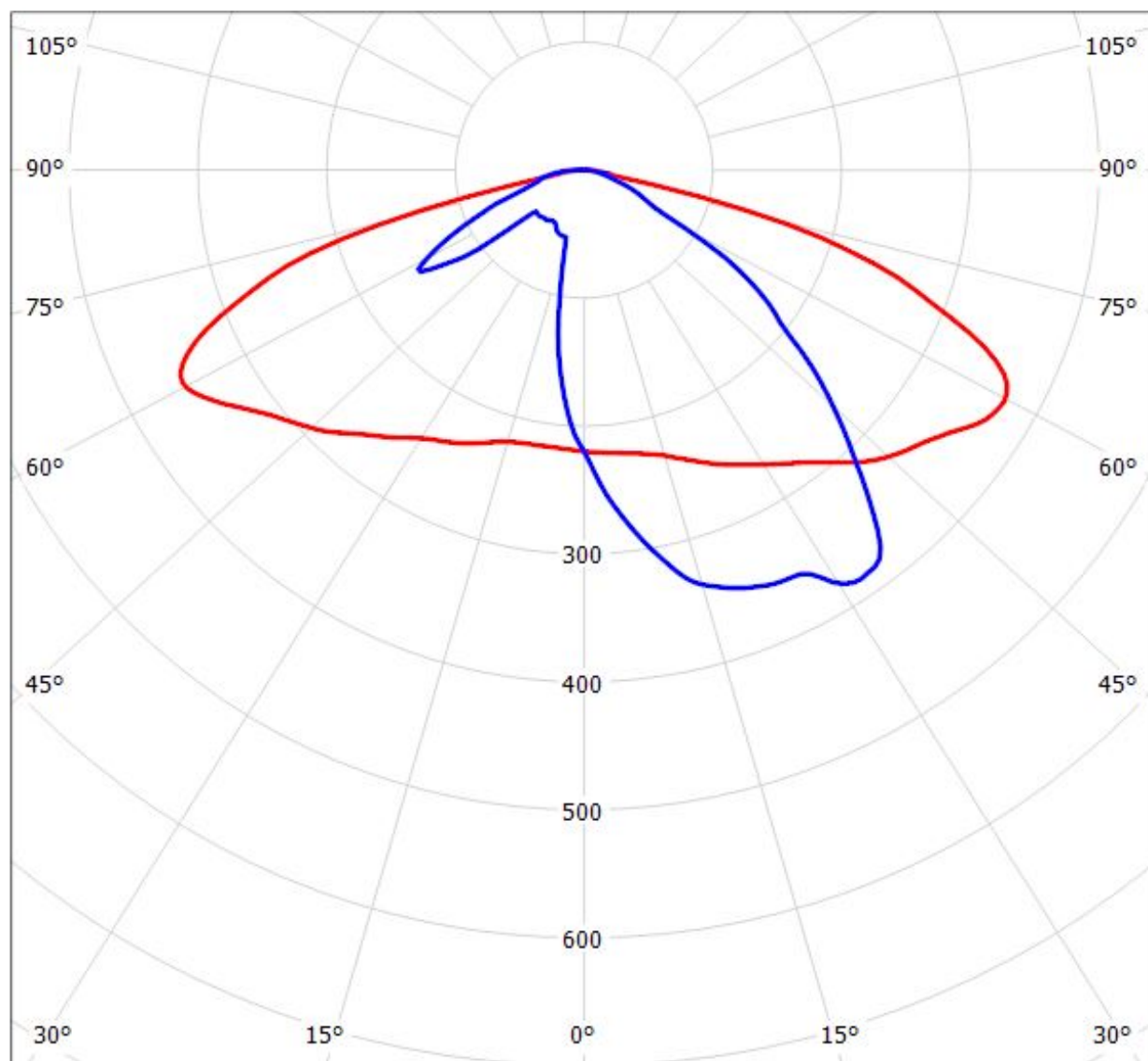

cd/klm

— C0 - C180 — C90 - C270

$\eta = 98\%$

Luminaire: LEDiL Oy CS14143_STRADA-IP-2X6-T3

Lamps: 1 x CREE_XT-E_6x2_(XTEAWT-00-0000-000000HE4)_1253.92lm@250mA_P=8.86265W_I=249.8mA

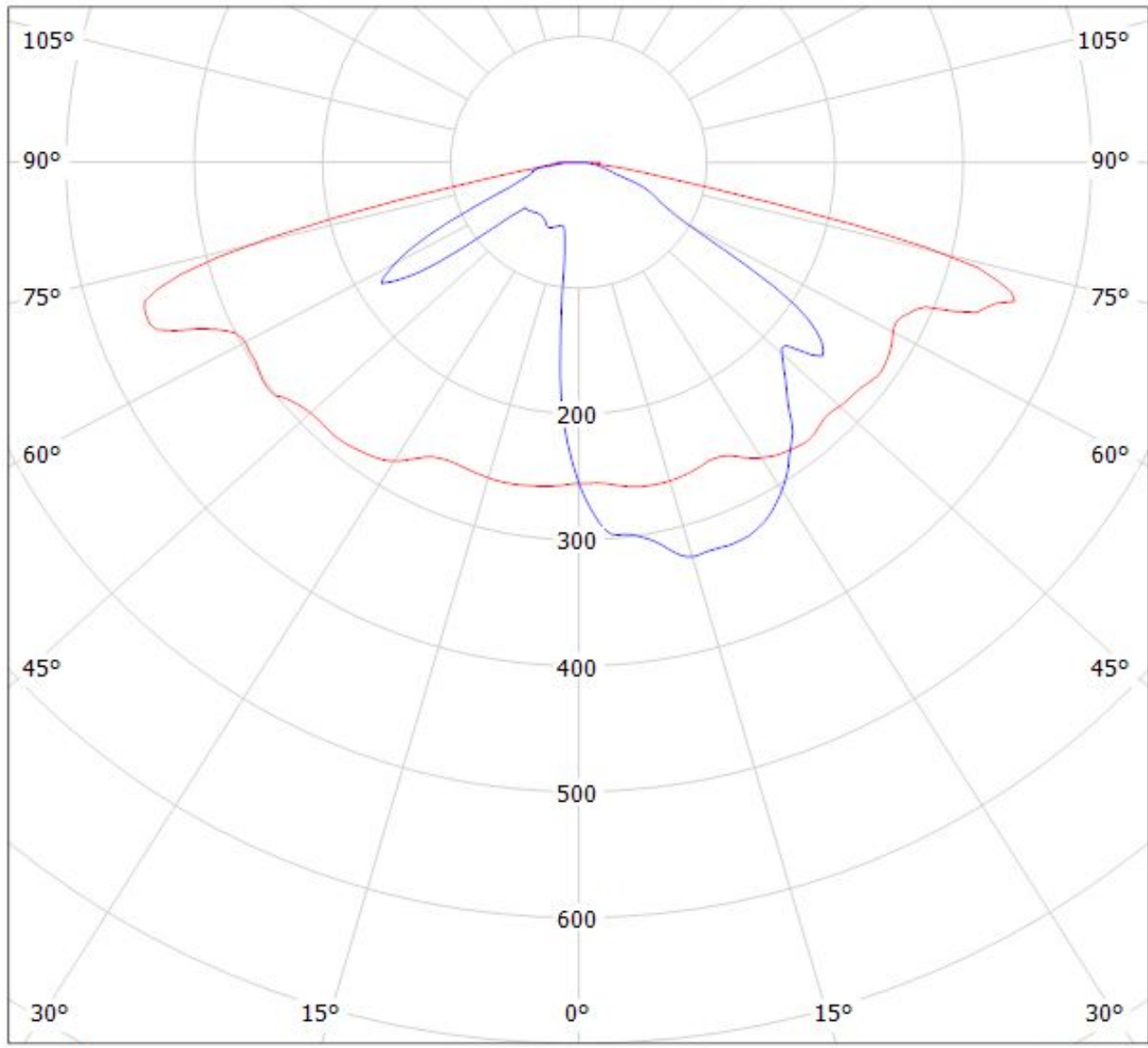

cd/klm

— C0 - C180

— C90 - C270

$\eta = 95\%$

Luminaire: LEDiL Oy CS14143_STRADA-IP-2X6-T3_(XP-G2) Eff.94.1%
Lamps: 1 x CREE_XP-G2_1277.8lm@250mA_P=8.54291W_I=249.8mA

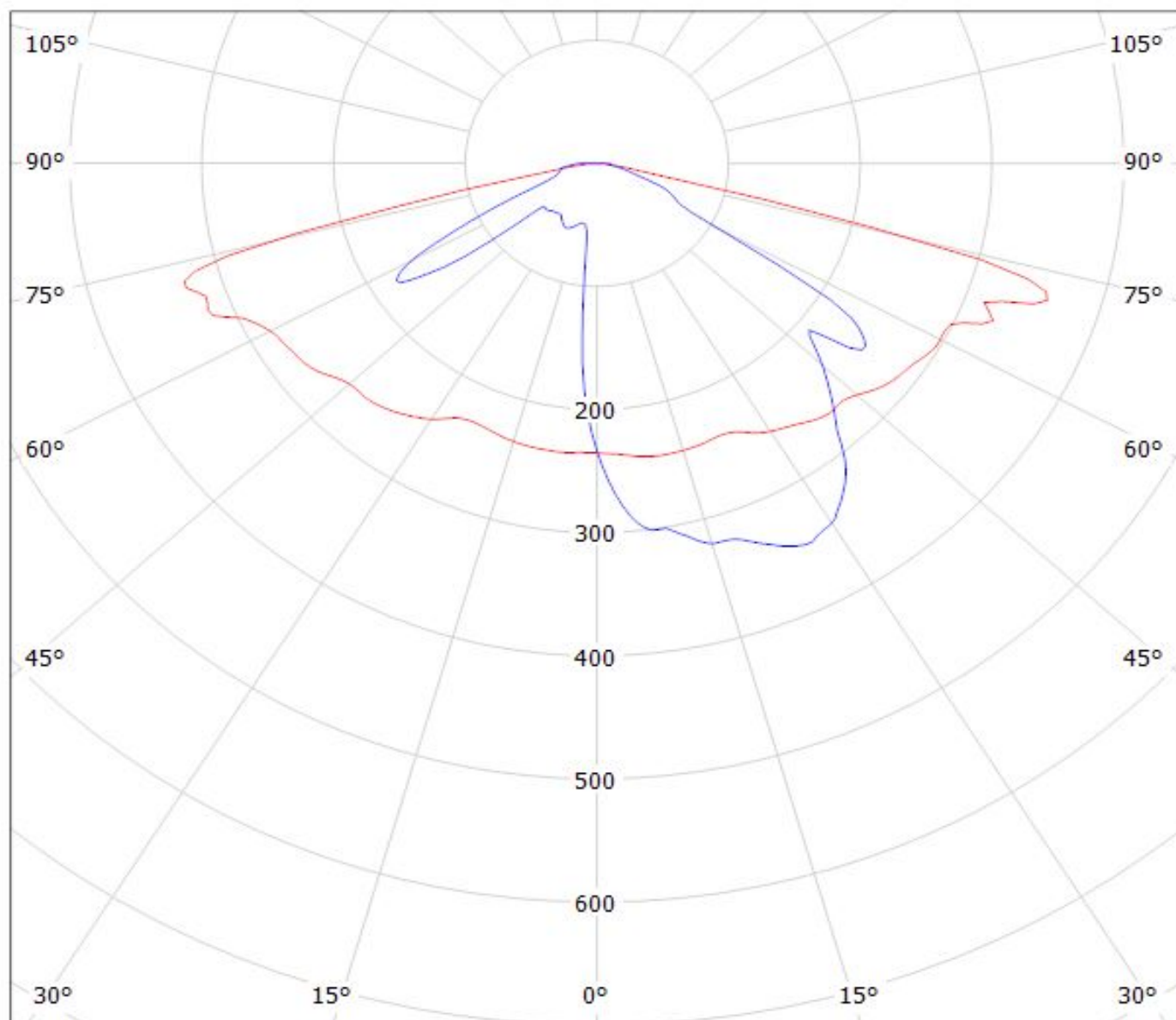

cd/klm

— C0 - C180 — C90 - C270

$\eta = 94\%$

Luminaire: LEDiL Oy CS14143_STRADA-IP-2X6-T3_(XP-L) Eff.95.3%
Lamps: 1 x CREE_XP-L_2x6_(XPLAWT-0-7A3-U50-0H-0001)
_1270.8lm@250mA_P=8.22317W_I=249.8mA

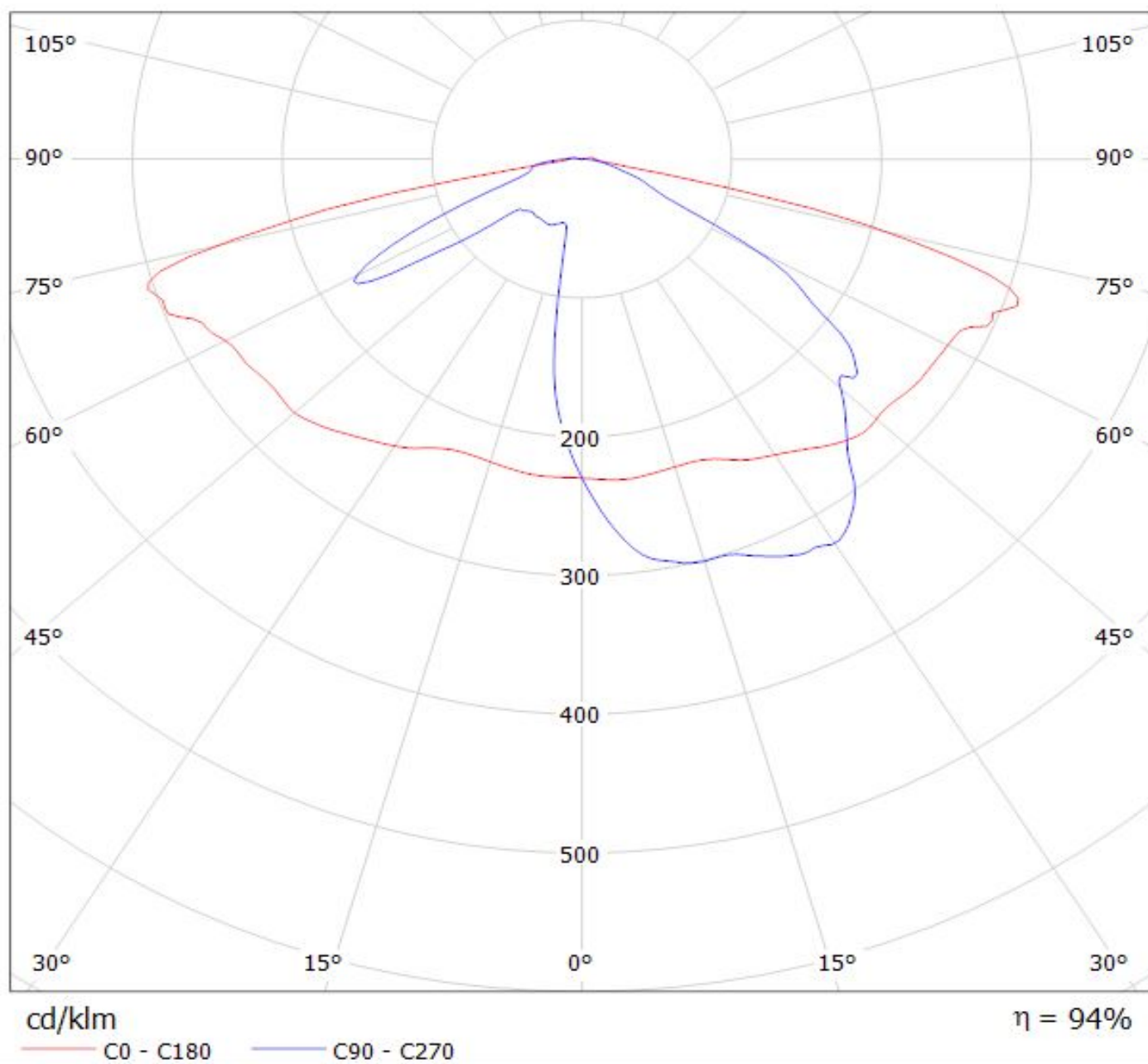

Luminaire: Ledil Oy CS14143_STRADA-IP-2X6-T3_(XP-G3)_SIMULATED

Lamps: 1 x Cree XP-G3

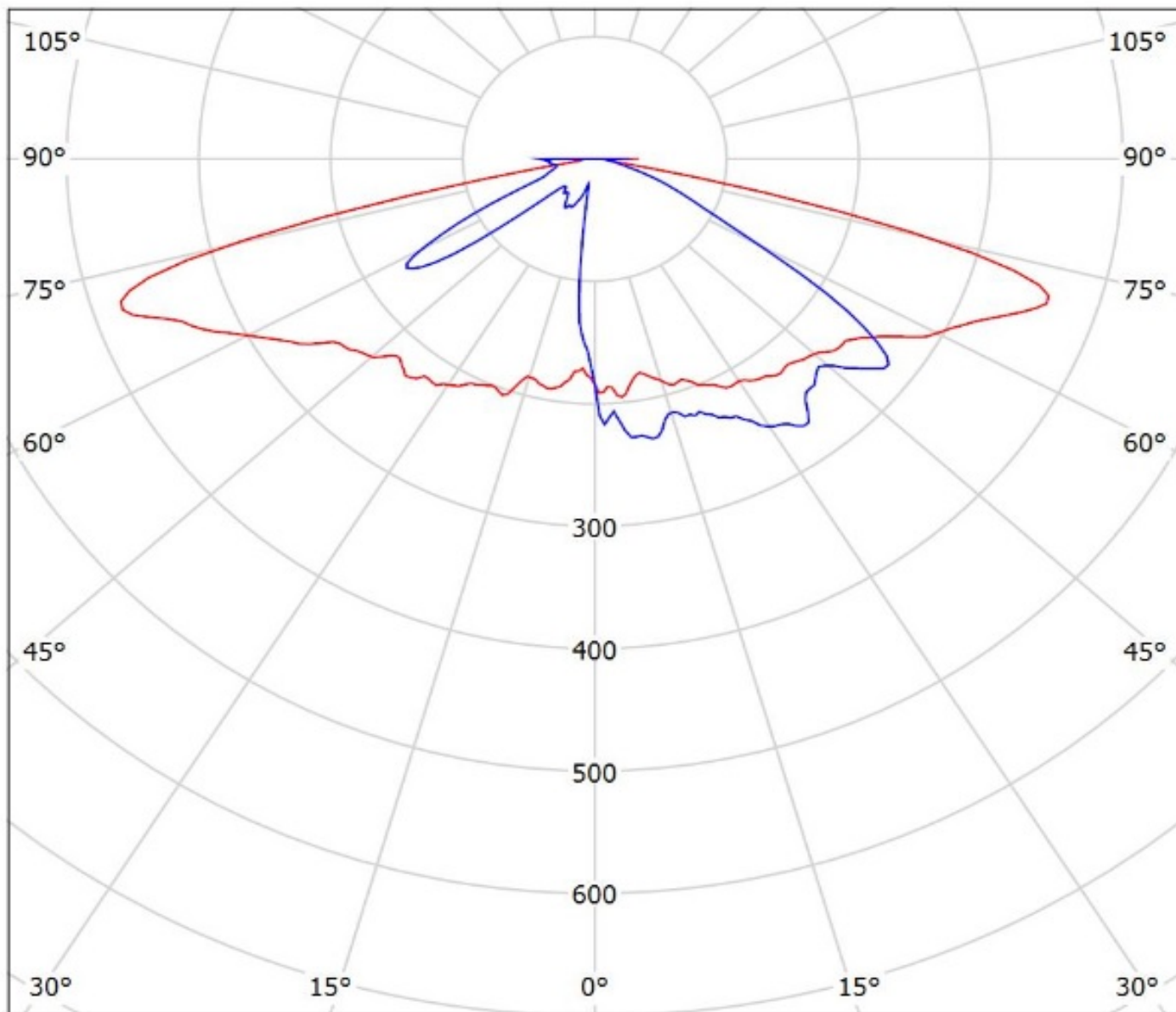

cd/klm

— C0 - C180 — C90 - C270

η = 88%

Luminaire: Ledil CS14143_STRADA-IP-2x6-T3_(XP-G3)

Lamps: 1 x Cree_XP-G3_6x2_(XPGDWT-B1-6C1-S3-0-01)_1521.26lm@250mA_P=8.253W_I=0.25A

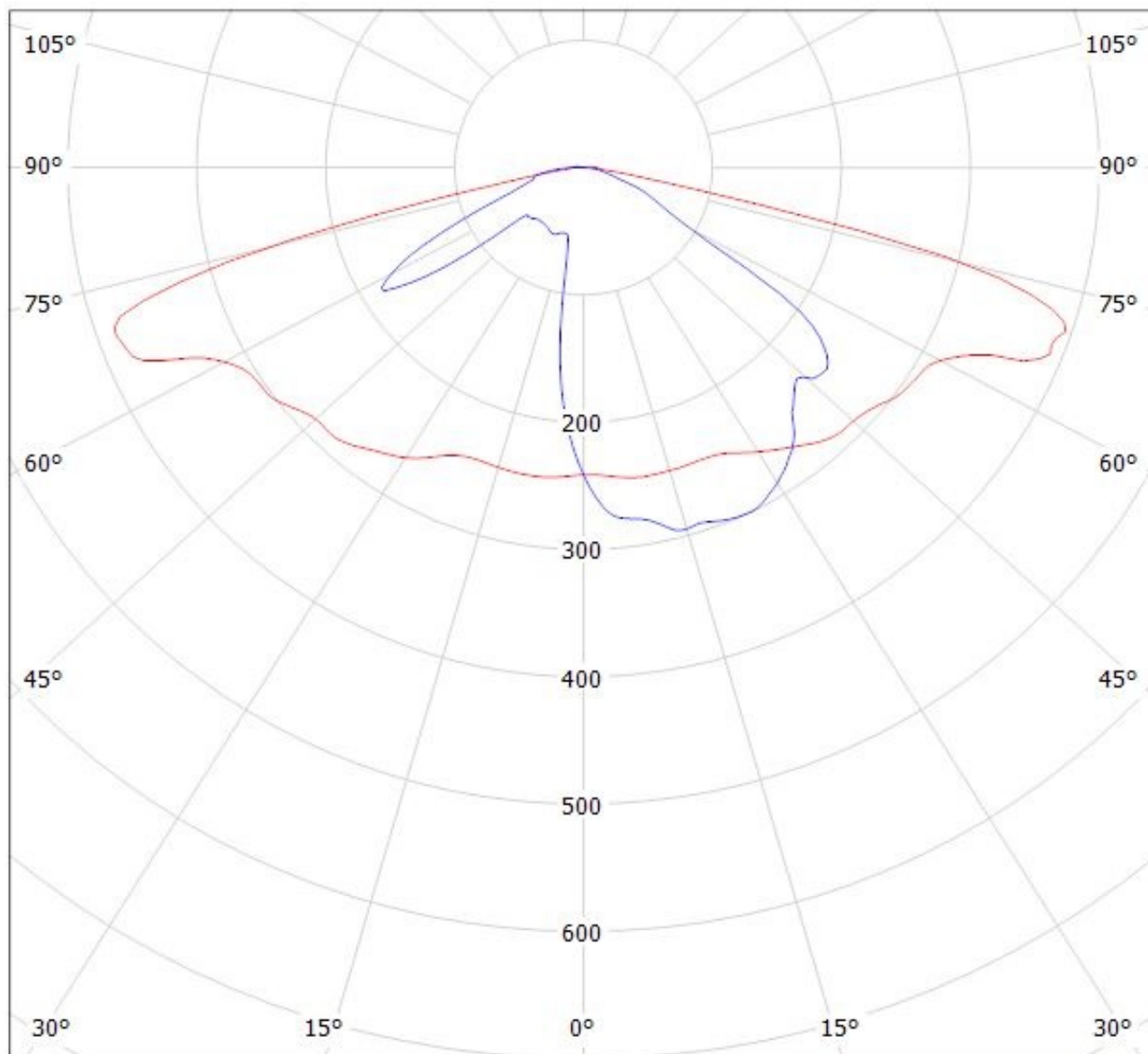

cd/klm

— C0 - C180

— C90 - C270

$\eta = 94\%$

Luminaire: Ledil CS14143_STRADA-IP-2X6-T3_(XP-L2)
Lamps: 1 x Cree_XP-L2x12_(XPGBWT-H1-3B0-R5-0-01)
1666.32lm@250mA_CCT=5000_P=8.239W_I=0.25A

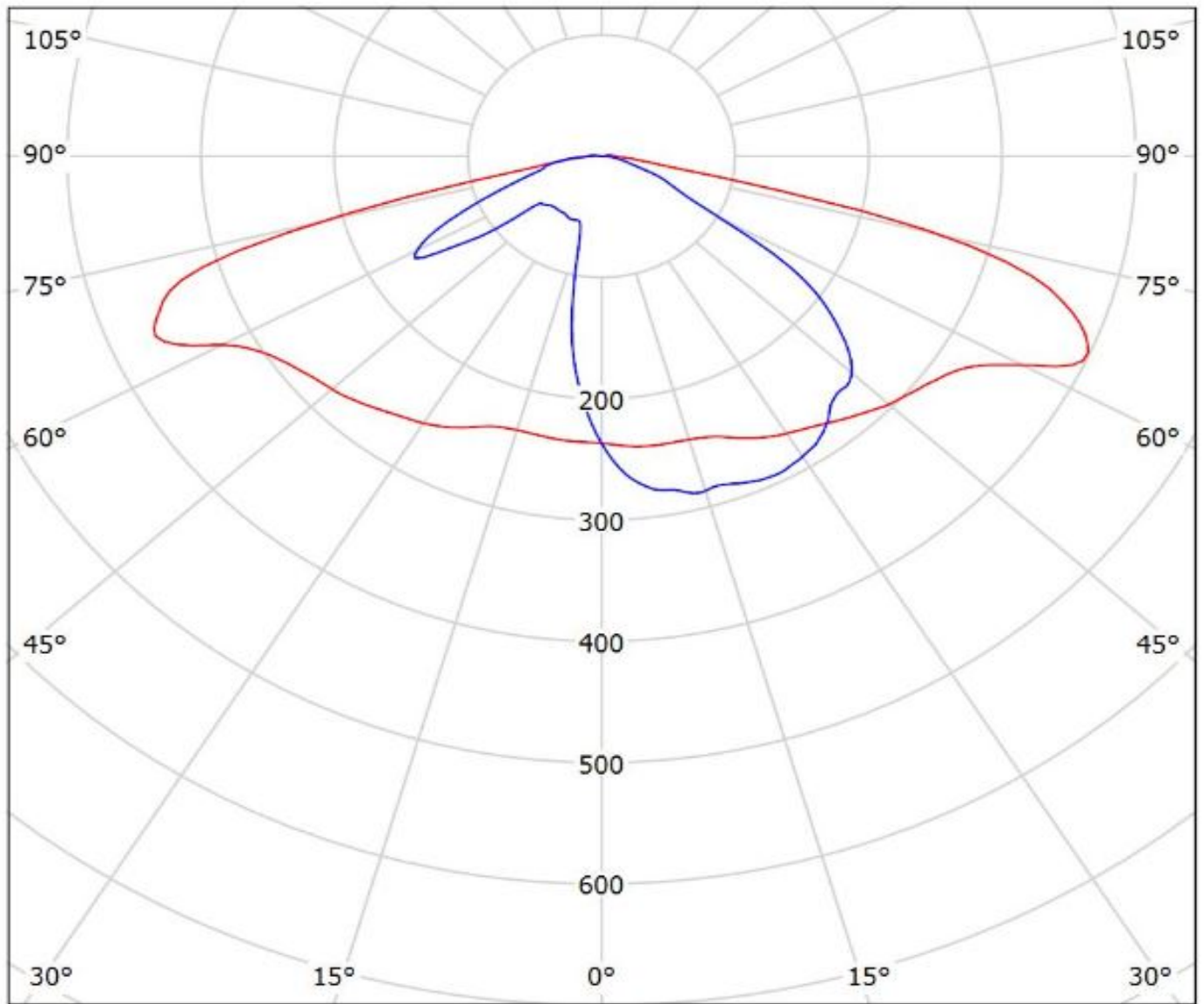

cd/klm

— C0 - C180 — C90 - C270

$\eta = 96\%$

Luminaire: LEDiL Oy CS14143_STRADA-IP-2X6-T3_(LG_3535_H35C1)

Lamps: 1 x LG_3535_H35C1_2x6_1360.63lm@250mA_P=8.55408W_I=249.9mA

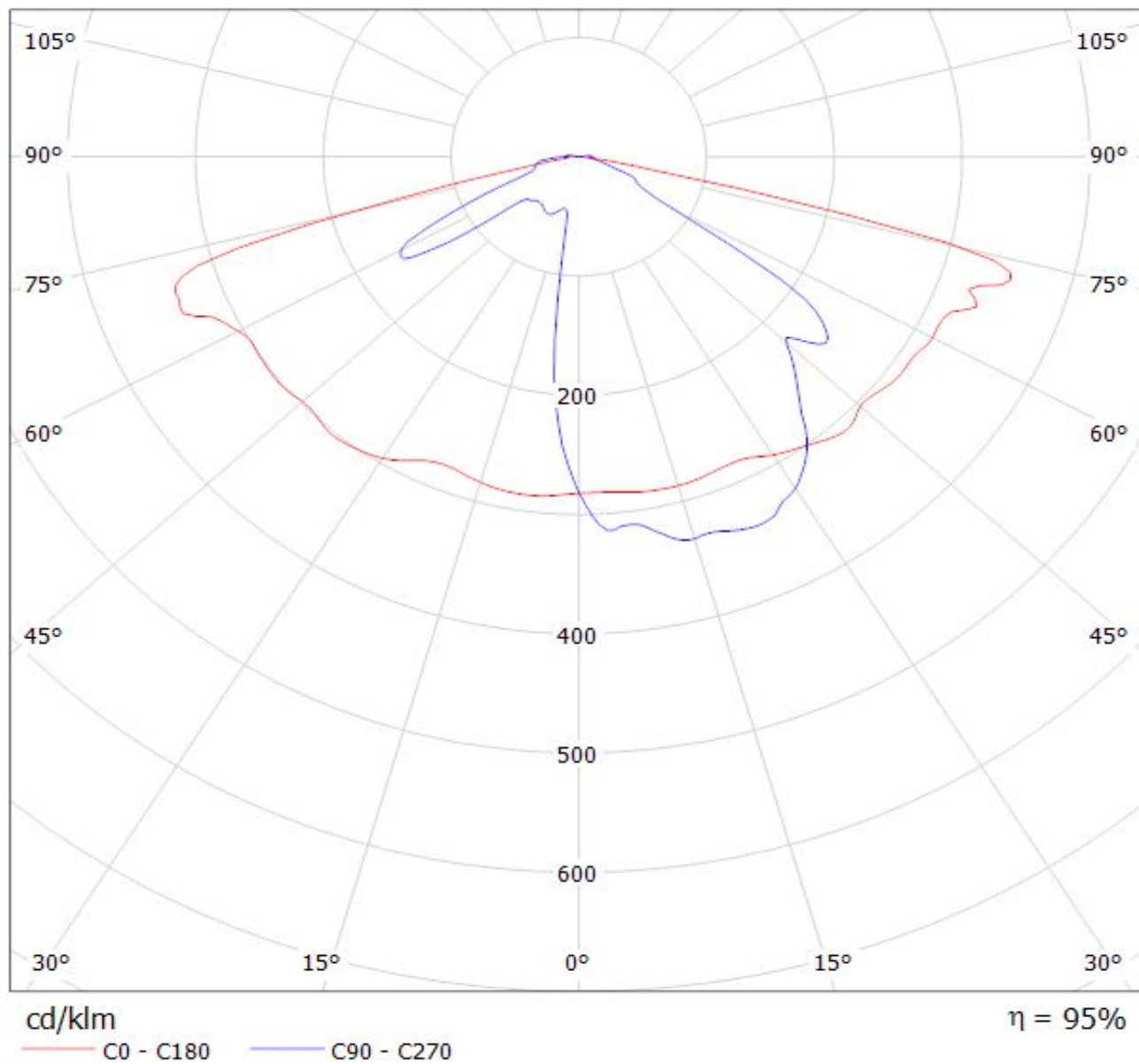

Luminaire: LEDiL Oy CS14143_STRADA-IP-2X6-T3_(LUXEON_Z_ES) Eff.94.0%
Lamps: 1 x LUXEON_Z_ES_984.3lm@250mA_P=8.31159W_I=249.8mA

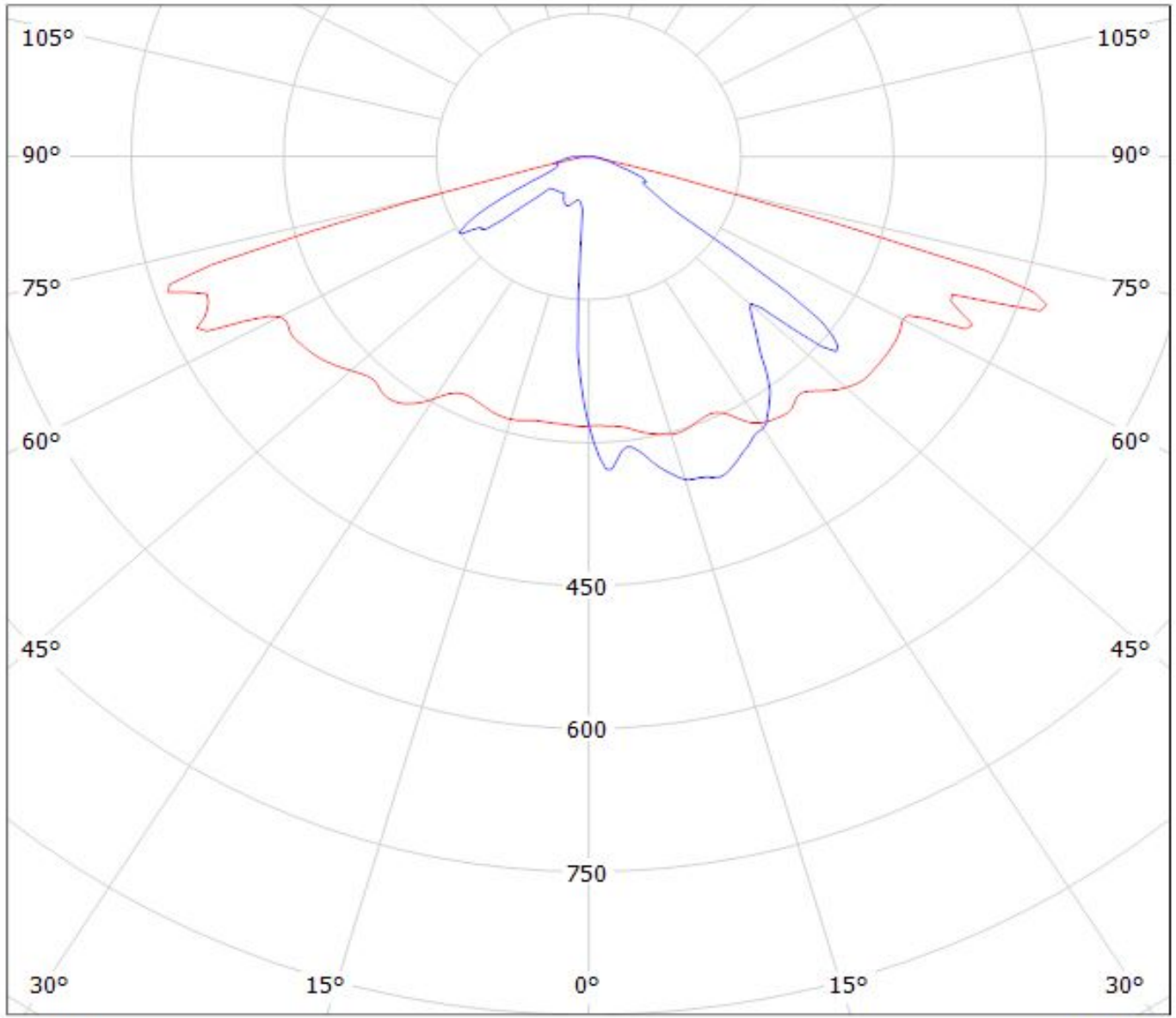

cd/klm

— C0 - C180 — C90 - C270

$\eta = 94\%$

Luminaire: Ledil CS14143_STRADA-IP-2X6-T3_(XR-TX)

Lamps: 1 x Luxeon_XR-TX_1377.67lm@250mA_P=8.3973W_I=0.250A

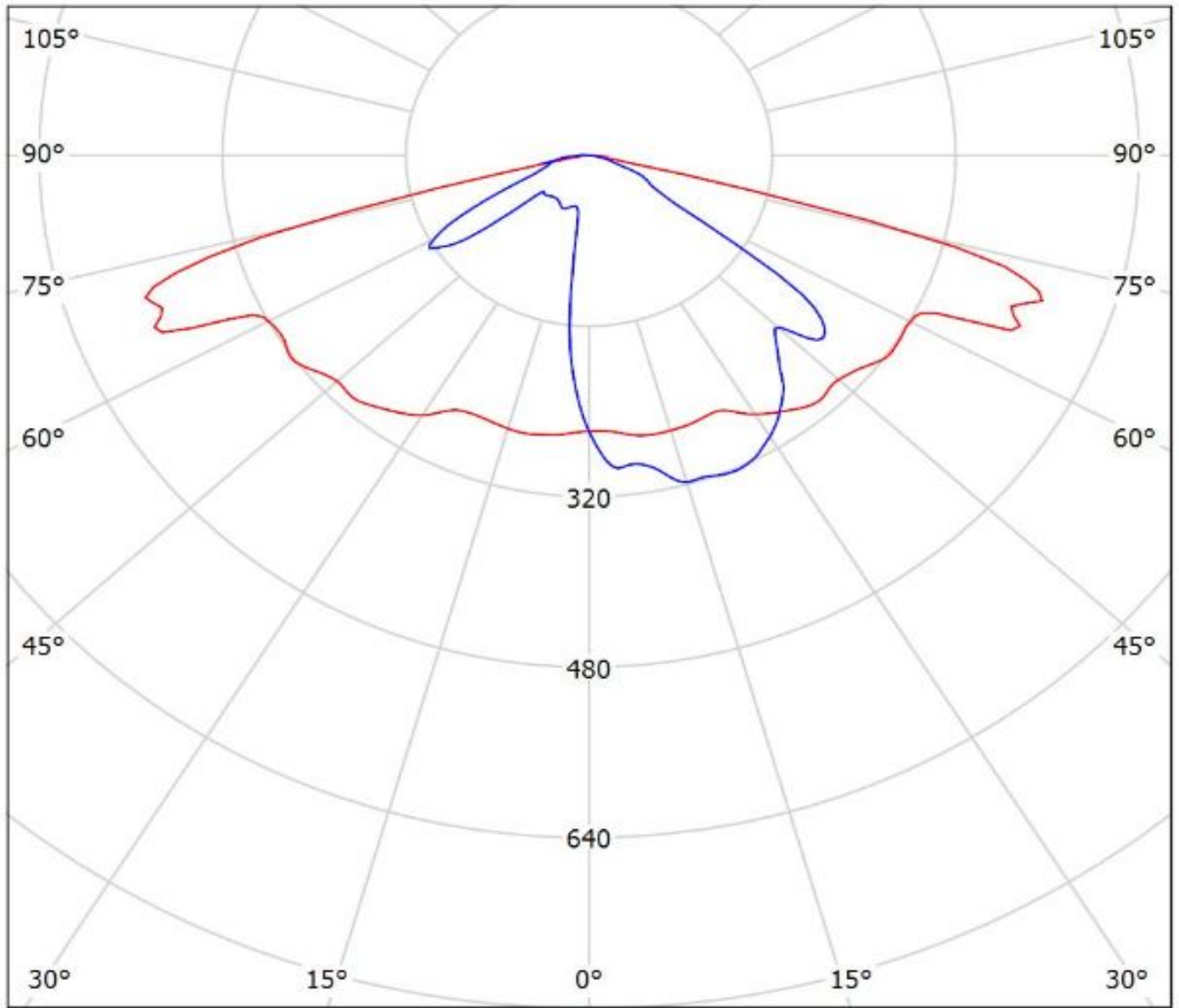

cd/klm

— C0 - C180 — C90 - C270

$\eta = 96\%$

Luminaire: Ledil Oy CS14143_STRADA-IP-2X6-T3_LUXEON-5050_SIMULATED
Lamps: 1 x Lumileds Luxeon 5050

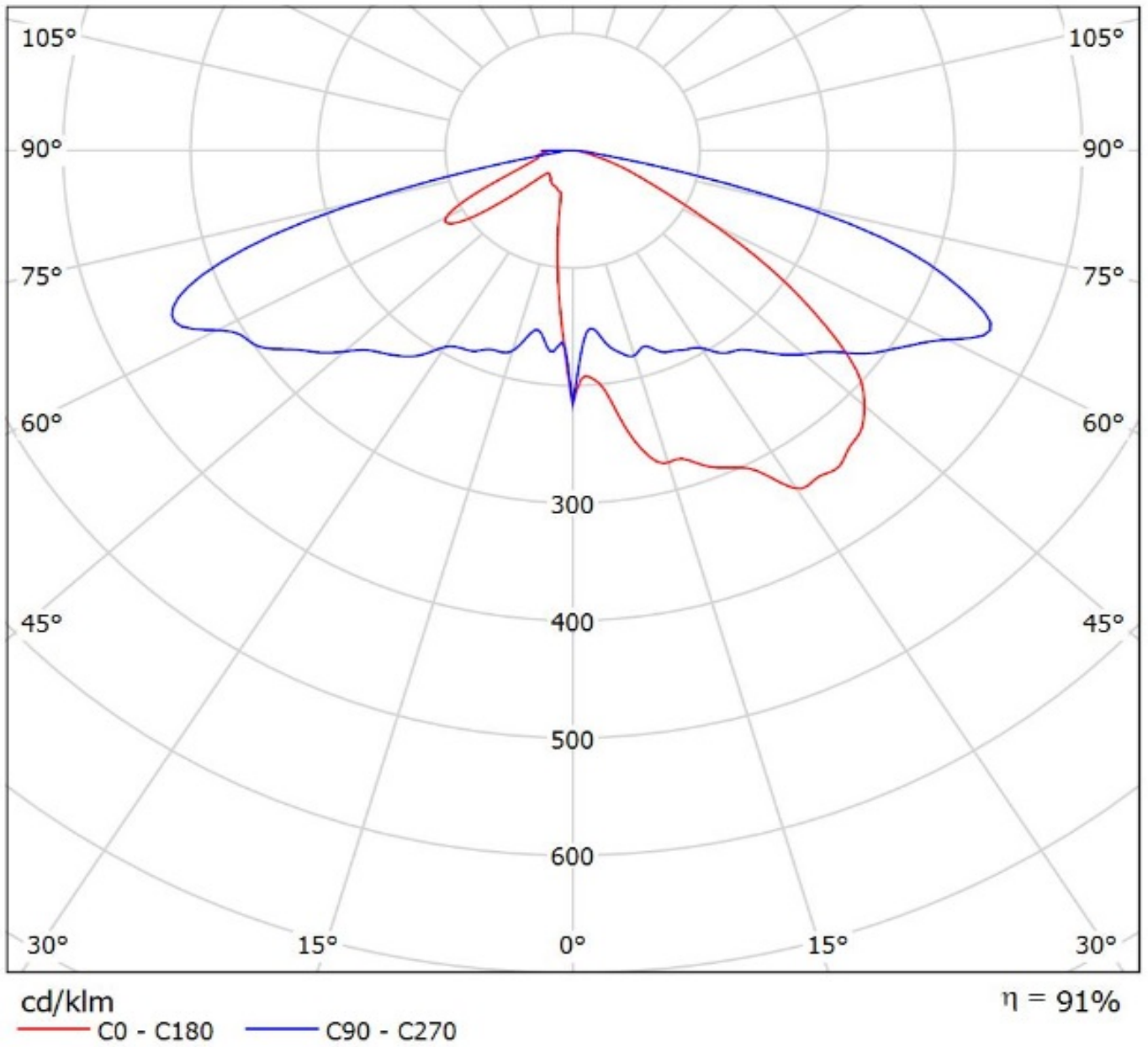

Luminaire: Ledil CS14143_STRADA-IP-2X6-T3_(NVSL219CT)
Lamps: 1 x Nichia_NVSL219CT_2x6_1262.53lm@250mA_P=8.35825W_I=0.25A

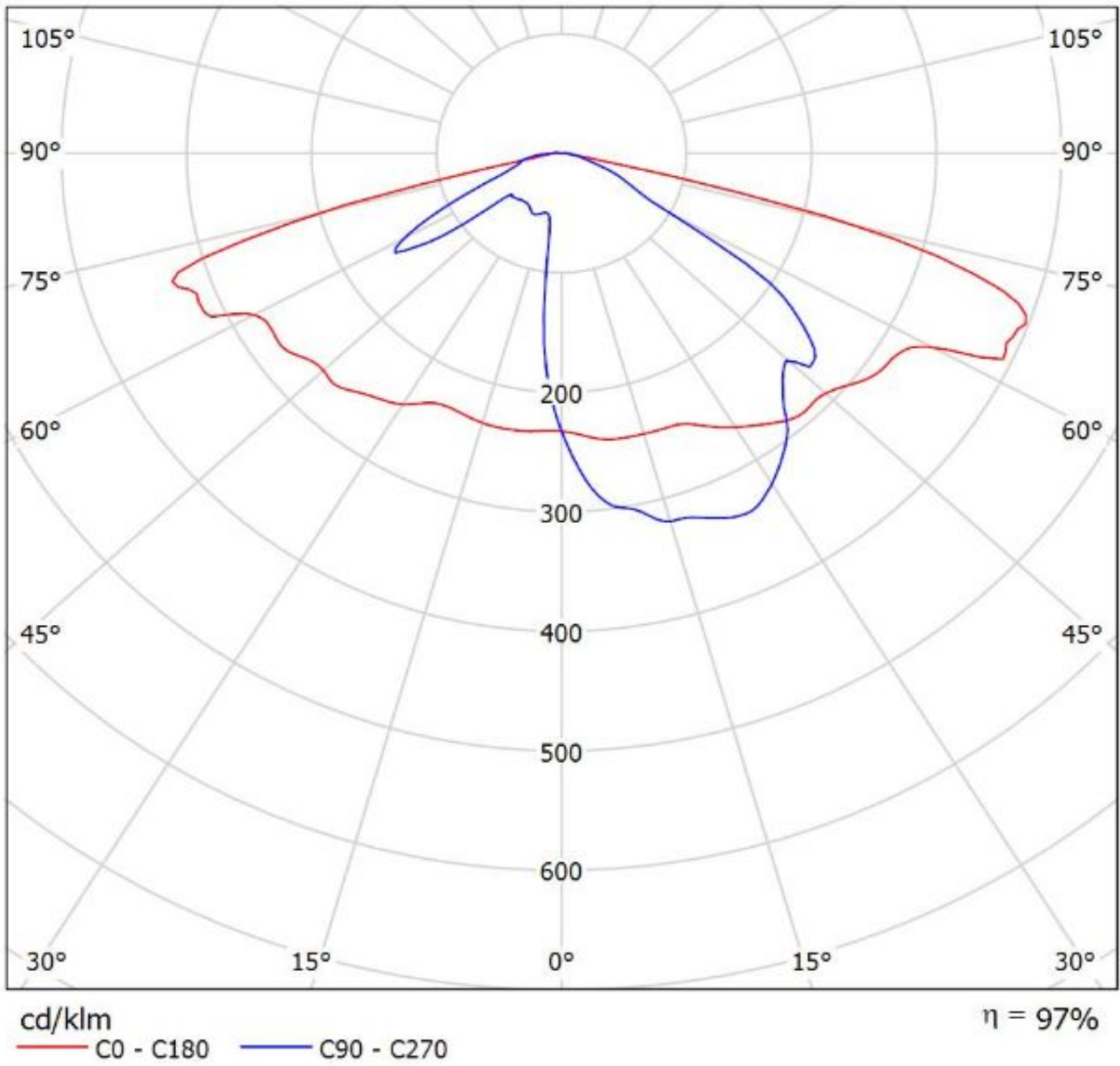

Luminaire: Ledil Oy CS14143_STRADA-IP-2X6-T3_(Duris_P8)_SIMULATED
Lamps: 1 x Osram Duris P8

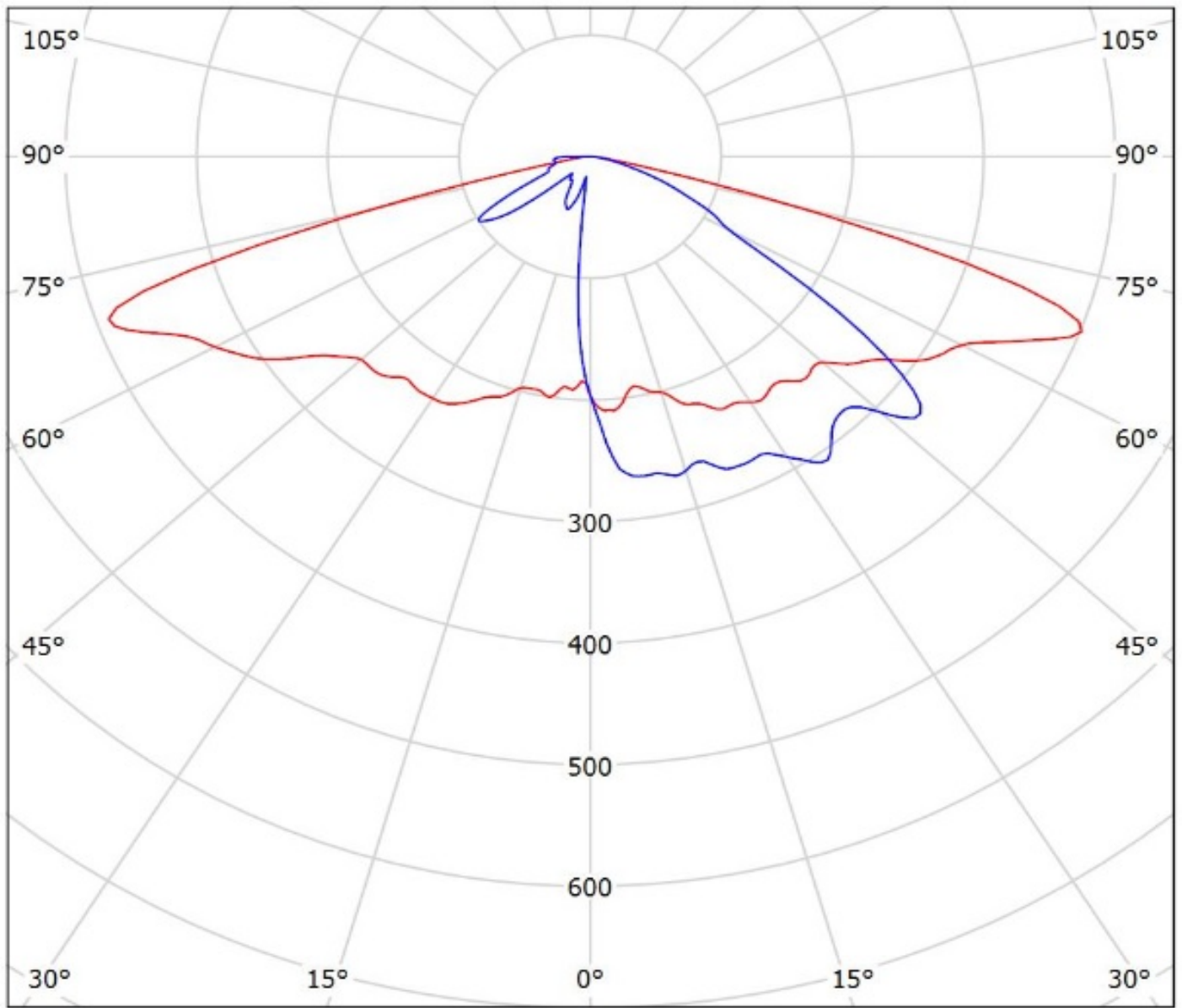

cd/klm

— C0 - C180 — C90 - C270

$\eta = 90\%$

Luminaire: LEDiL Oy CS14143_STRADA-IP-2X6-T3_Fortimo FastFlex LED board 2x6 DP G4
Lamps: 1 x Fortimo FastFlex LED board 2x6 DP G4

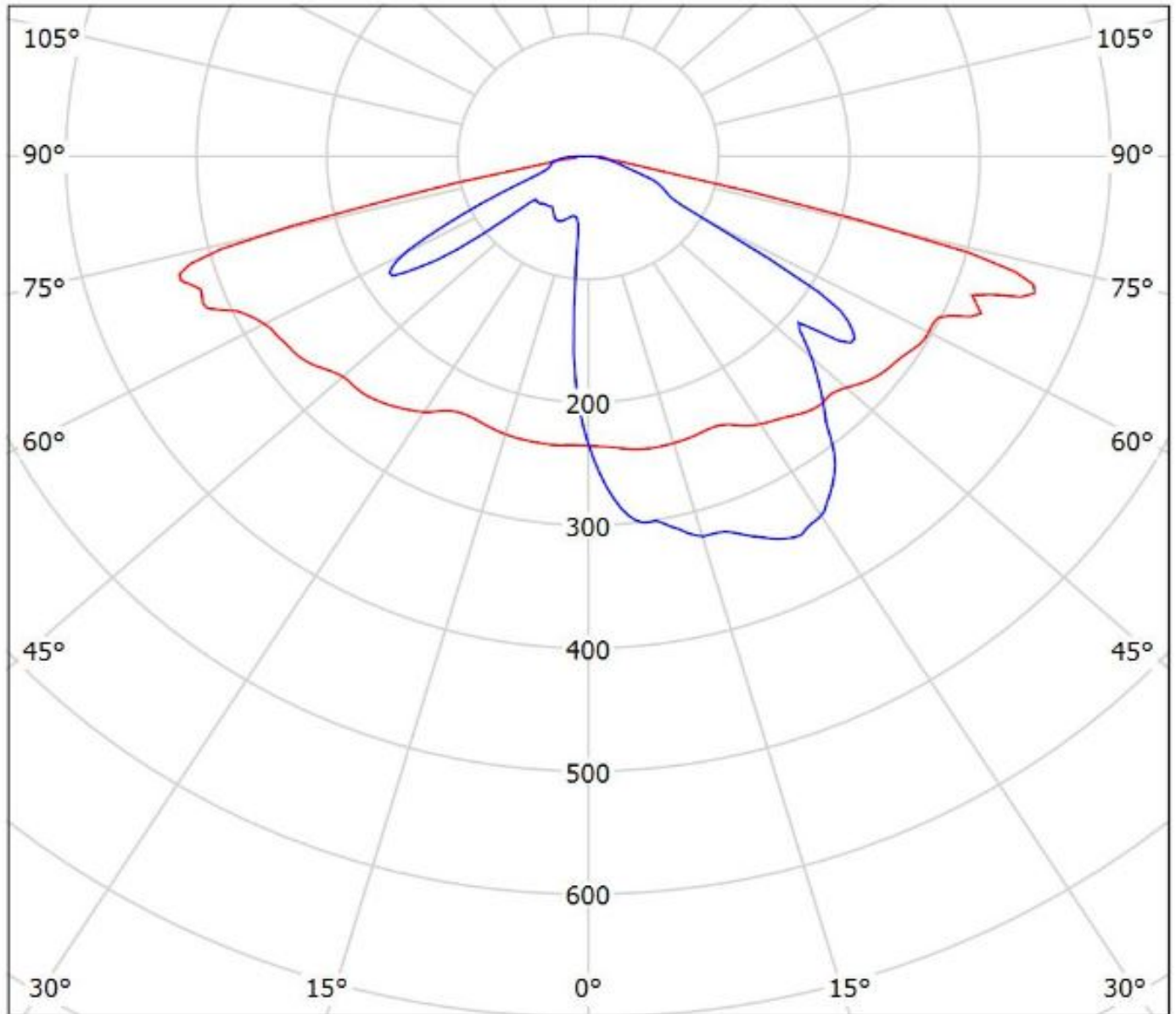

cd/klm

— C0 - C180 — C90 - C270

$\eta = 94\%$

Luminaire: Ledil CS14143_STRADA-IP-2x6-T3_Fortimo FastFlex LED board 2x6 DPX G4
Lamps: 1 x Fortimo FastFlex LED board 2x6 DPX G4

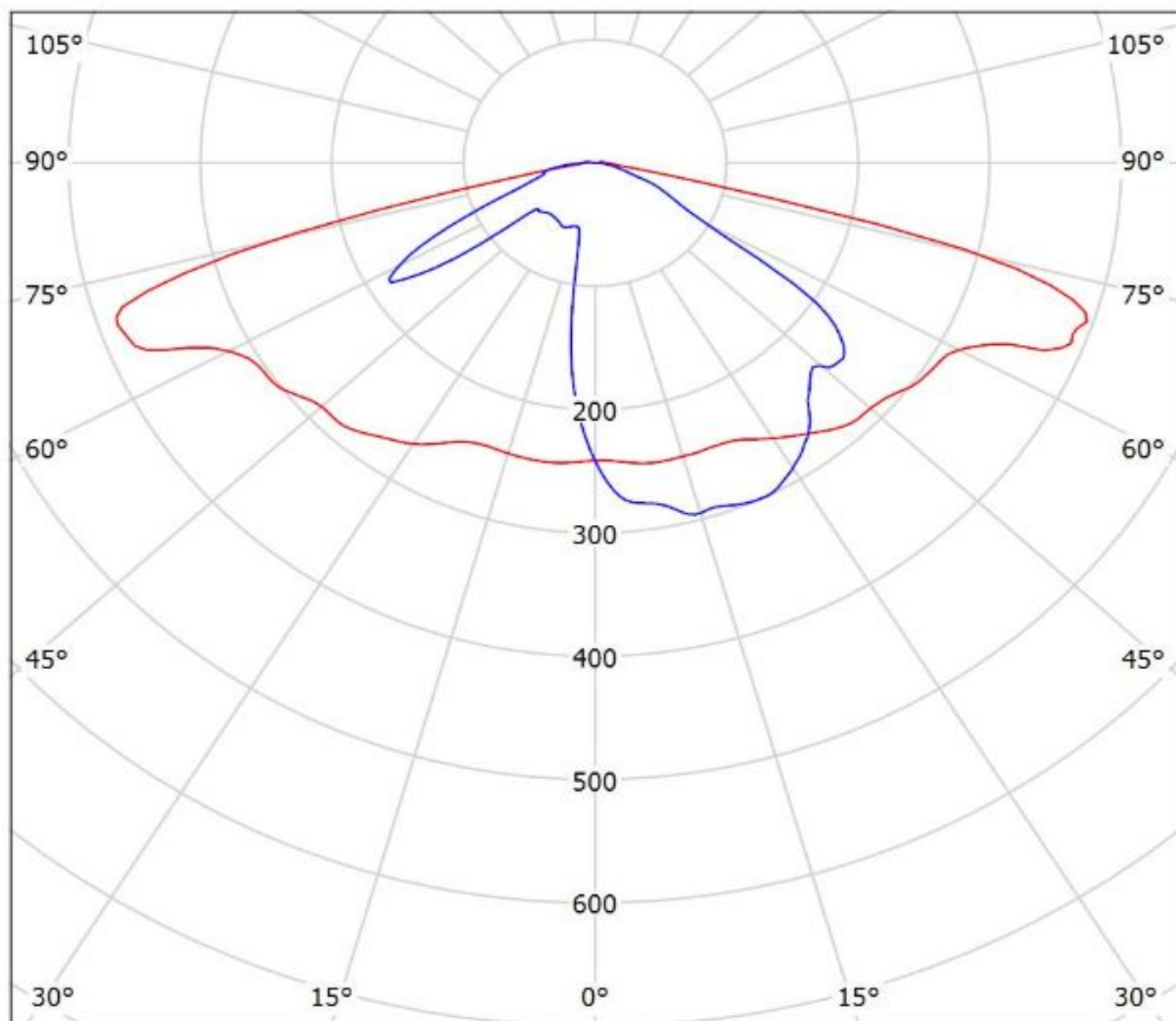

cd/klm
— C0 - C180 — C90 - C270

$\eta = 97\%$

Luminaire: LEDiL Oy CS14143_STRADA-IP-2X6-T3_(LH351Z)

Lamps: 1 x SAMSUNG_LH351Z_2x6_960.75lm@250mA_P=8.67003W_I=249.9mA

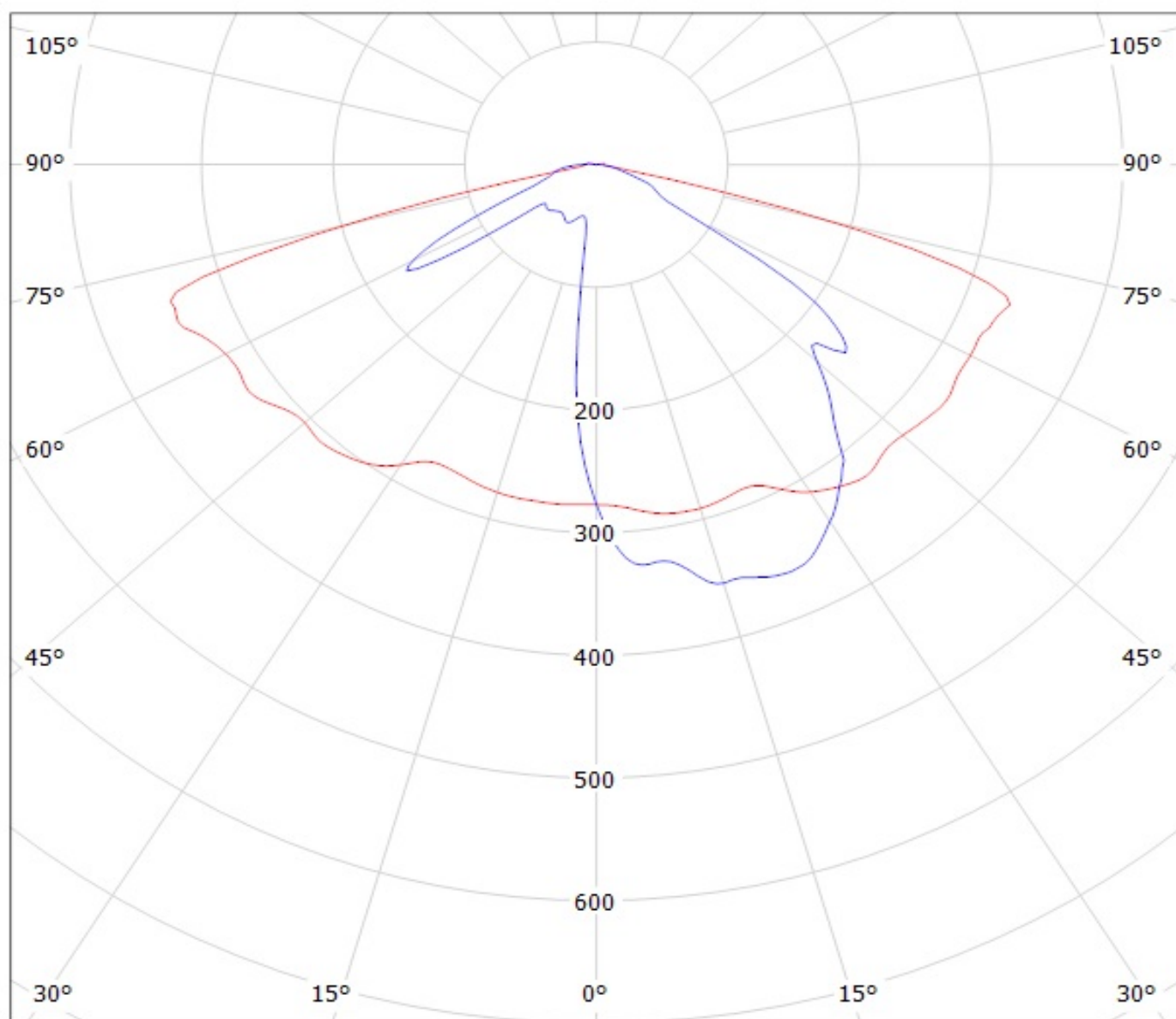

cd/klm

— C0 - C180

— C90 - C270

$\eta = 94\%$

Luminaire: Ledil Oy CS14143_STRADA-IP-2X6-T3_(LH351B)_SIMULATED
Lamps: 1 x Samsubng LH351B

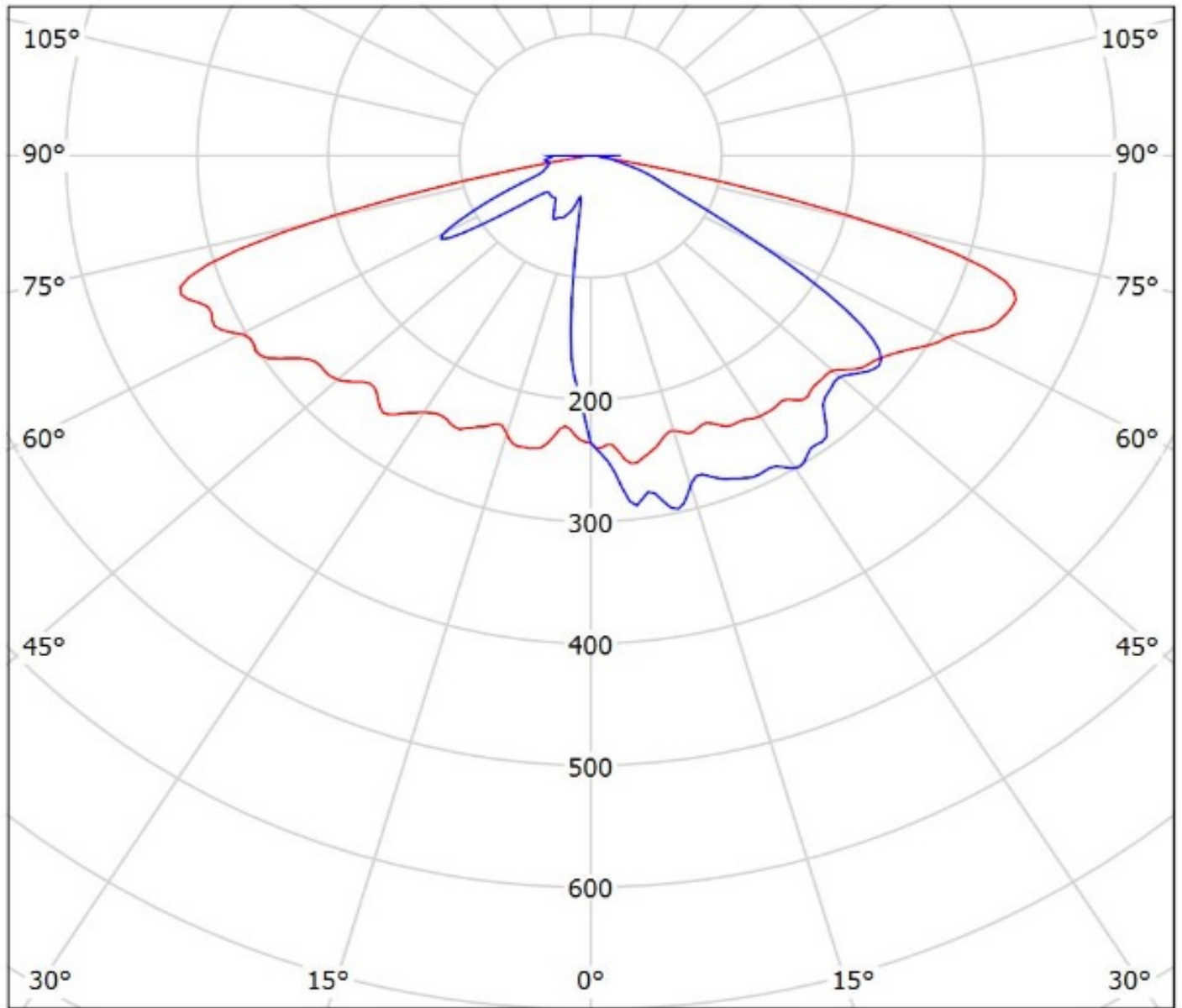

cd/klm

— C0 - C180 — C90 - C270

$\eta = 93\%$

Luminaire: Ledil Oy CS14143_STRADA-IP-2X6-T3_(Z5M1)_SIMULATED
Lamps: 1 x Seoul Z5M1

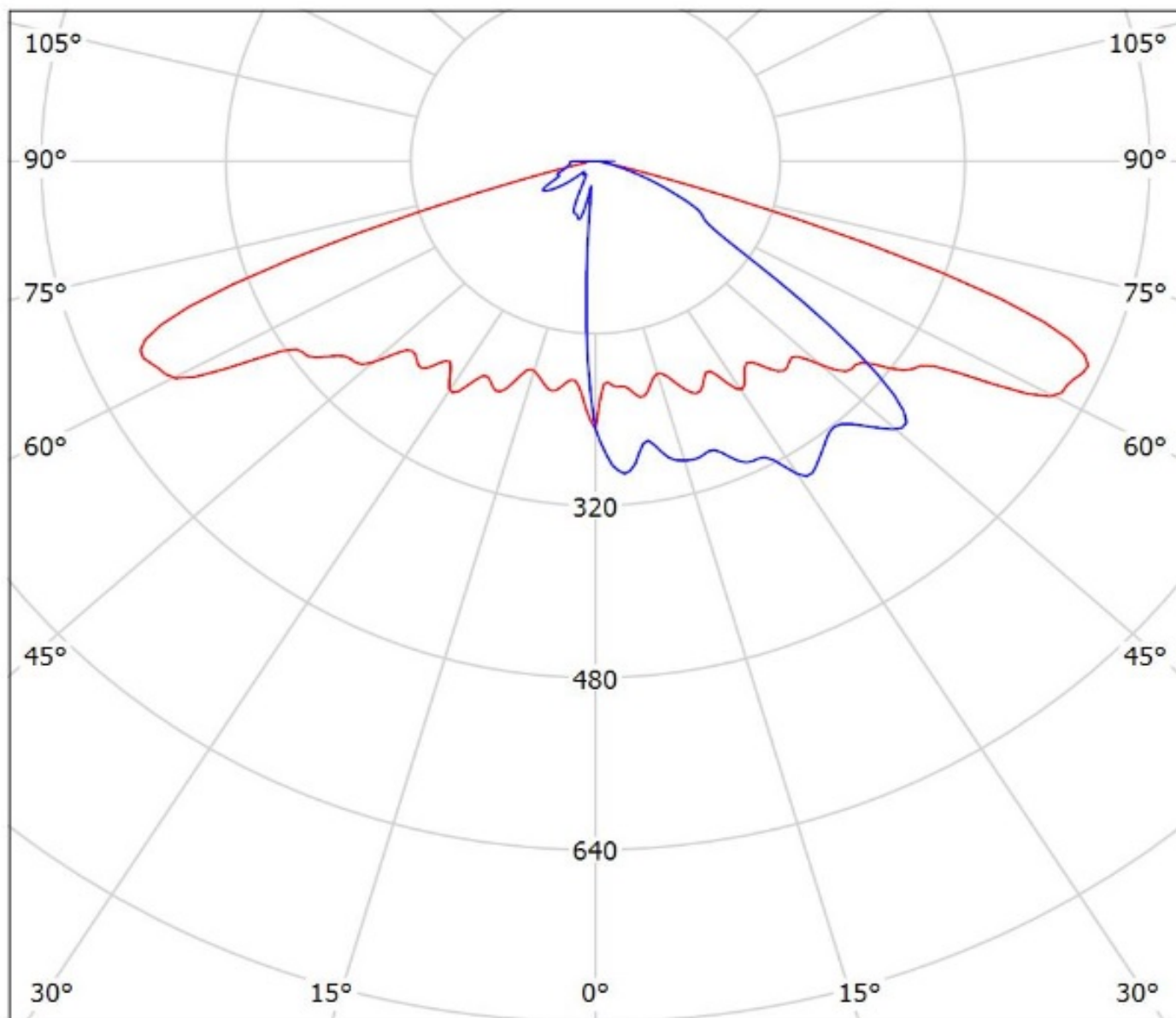

cd/klm
— C0 - C180 — C90 - C270

$\eta = 91\%$

Luminaire: Ledil CS14143_STRADA-IP-2X6-T3_(Z8Y22_PLUS)

Lamps: 1 x Seoul_Z8Y22_PLUS_2X6_(SZ8-Y22-W0-C7P)1489.65lm@250mA_P=8.30675W_I=0.250A

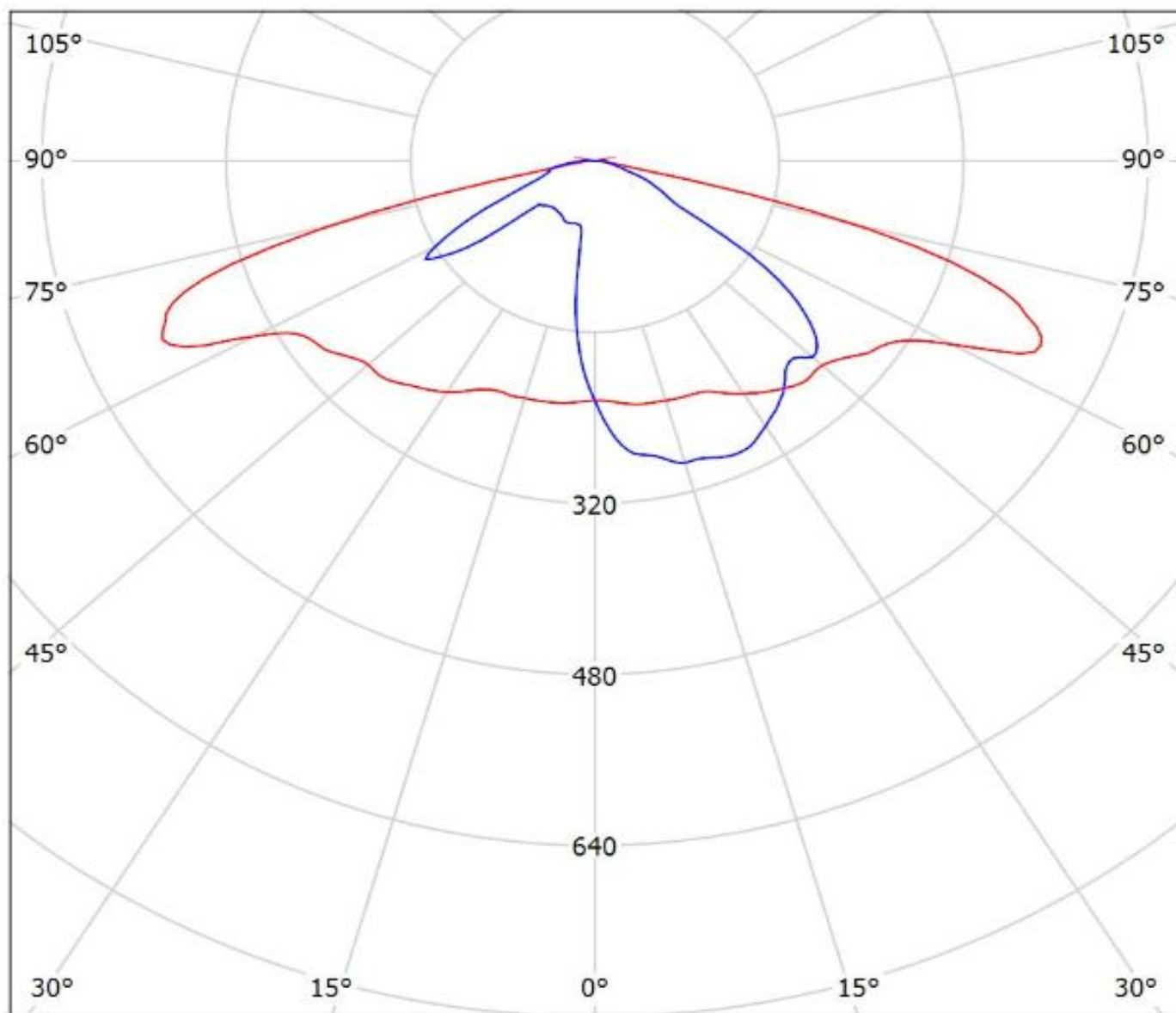

cd/klm

— C0 - C180 — C90 - C270

$\eta = 97\%$

NOTE: The typical divergence will be changed by different color, chip size and chip position tolerance. The typical total divergence is the full angle measured where the luminous intensity is half of the peak value.