

THIS DRAWING IS UNPUBLISHED. RELEASED FOR PUBLICATION
 © COPYRIGHT - BY TYCO ELECTRONICS CORPORATION. ALL RIGHTS RESERVED.

LOC	DIST	REVISIONS					
		P	LTR	DESCRIPTION	DATE	DWN	APVD
H	-		A	RELEASED FOR PRODUCTION	24OCT2016	RK	MvE
			A1	CHANGED LASER MARKING	03NOV2016	RK	MvE

DIMENSIONS BEFORE APPLICATION

NOTES:

- 2213600-1 AS SHOWN.
- MATERIALS:

CONTACT: PHOSPHOR BRONZE, TIN PLATED
 HOUSING: PC NOT GLASS FILLED
 BUTTONS: PC NOT GLASS FILLED

- 3 LASER MARKING:
- (KEMA) PENDING
 - (UL) PENDING
 - TE LOGO
 - TE PART NUMBER
 - DATE CODE

4 LASER MARKING: IP20

5 LASER MARKING: IP x5/x7

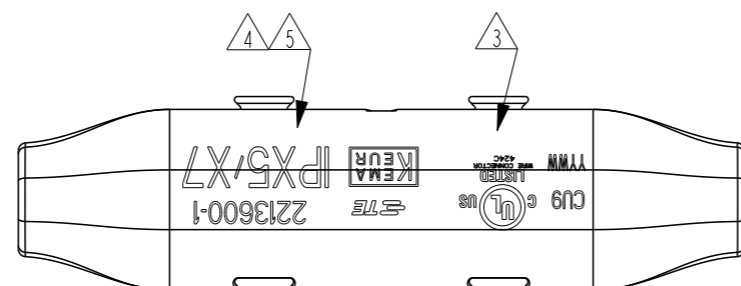
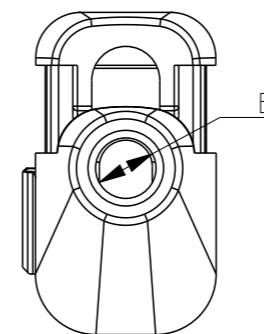
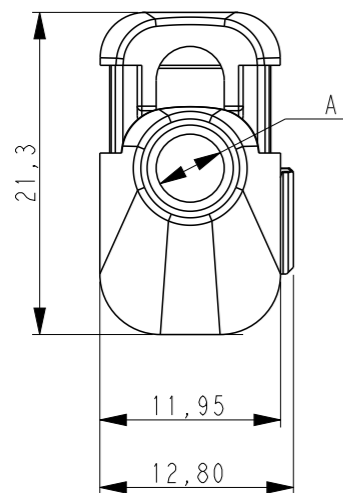
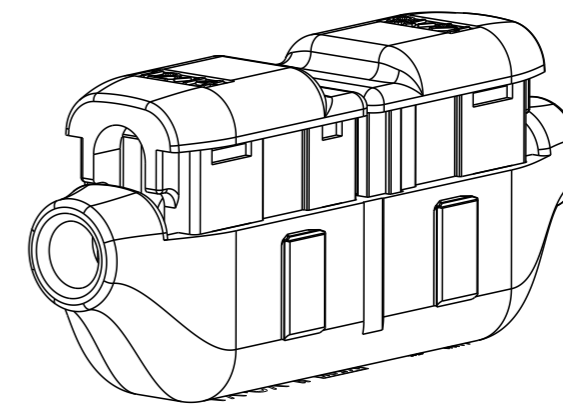
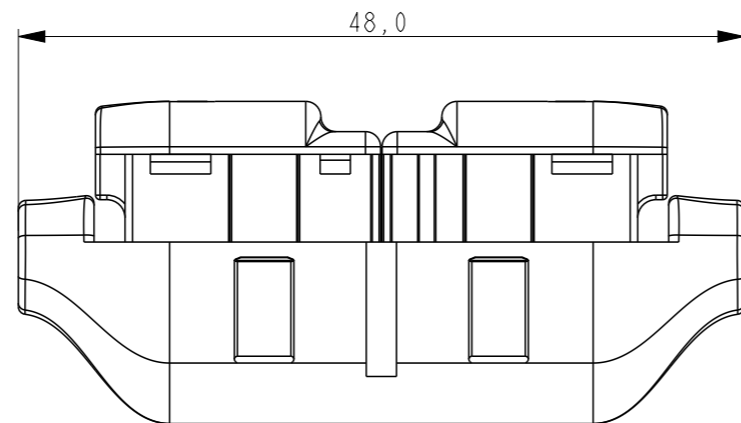
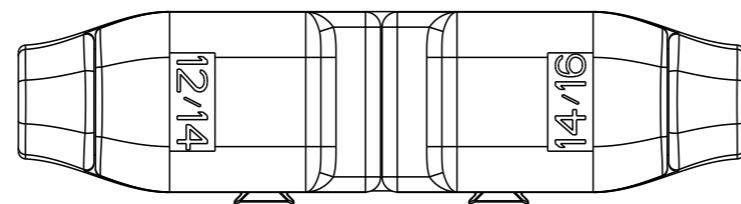

UNSEALED	4	A=4.0 B=3.5	14/16 TO 16/18	BLUE AND RED	CLEAR	2213600-6
UNSEALED	4	A=4.5 B=3.5	12/14 TO 16/18	YELLOW AND RED	CLEAR	2213600-5
UNSEALED	4	A=4.5 B=4.0	12/14 TO 14/16	YELLOW AND BLUE	CLEAR	2213600-4
SEALED	5	A=4.0 B=3.5	14/16 TO 16/18	BLUE AND RED	CLEAR	2213600-3
SEALED	5	A=4.5 B=3.5	12/14 TO 16/18	YELLOW AND RED	CLEAR	2213600-2
SEALED	5	A=4.5 B=4.0	12/14 TO 14/16	YELLOW AND BLUE	CLEAR	2213600-1
SEALING		WIRE ENTRY	WIRE SIZE	BUTTON COLORS	HOUSING COLOR	PART NUMBER

THIS DRAWING IS A CONTROLLED DOCUMENT. DIMENSIONING AND TOLERANCING PER ASME Y14.5M-2009.		DWN M.V.ESSEN 06 NOV'15	TE Connectivity				
DIMENSIONS: mm		CHK C.V.STEENDEREN					
TOLERANCES UNLESS OTHERWISE SPECIFIED:		APVD O.IEIJNSE	NAME COOL SPLICE ONE POSITION LARGE WIRE GAUGE				
0 PLC ±- 1 PLC ±0,2 2 PLC ±0,2 3 PLC ±- 4 PLC ±- ANGLES ±-		PRODUCT SPEC 108-133061					
MATERIAL -		FINISH -	APPLICATION SPEC 114-133061	SIZE A3	CAGE CODE 00779	DRAWING NO C-2213600	RESTRICTED TO -
CUSTOMER DRAWING			WEIGHT -	SCALE 2:1	SHEET 1	OF 3	REV A1

THIS DRAWING IS UNPUBLISHED.

RELEASED FOR PUBLICATION

© COPYRIGHT - BY TYCO ELECTRONICS CORPORATION. ALL RIGHTS RESERVED.

LOC	DIST	REVISIONS					
		P	LTR	DESCRIPTION	DATE	DWN	APVD
		-		SEE SHEET 1	-	-	-

DIMENSIONS AFTER APPLICATION

NOTE:
1. 2213600-1 AS SHOWN.

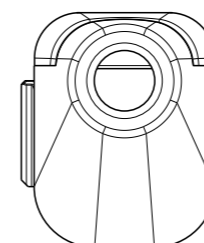
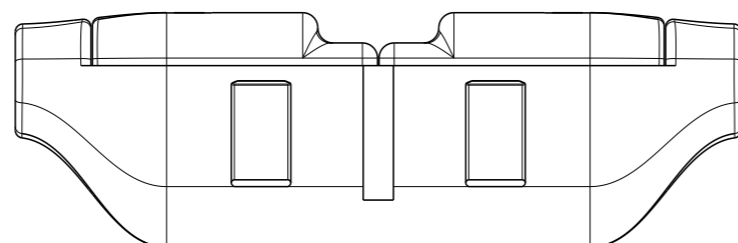
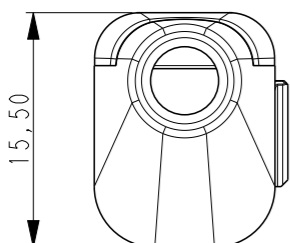
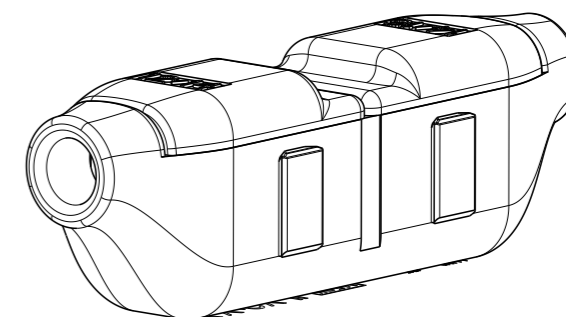
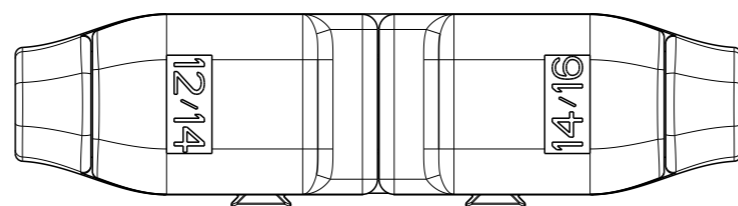

THIS DRAWING IS A CONTROLLED DOCUMENT.		DWN M.V.ESSSEN	06 NOV '15	 TE Connectivity	
DIMENSIONS: mm		CHK C.V.STEENDEREN	-		
TOLERANCES UNLESS OTHERWISE SPECIFIED:		APVD O.IEIJNSE	-	NAME COOL SPLICE ONE POSITION LARGE WIRE GAUGE	
0 PLC ±- 1 PLC ±0,2 2 PLC ±0,2 3 PLC ±- 4 PLC ±- ANGLES ±-		PRODUCT SPEC 108-133061	-	RESTRICTED TO	
MATERIAL		APPLICATION SPEC 114-133061	-	SIZE A3	CAGE CODE 00779
FINISH		WEIGHT	-	DRAWING NO C-2213600	REV A1
		CUSTOMER DRAWING	SCALE 1:1	SHEET 2 OF 3	

THIS DRAWING IS UNPUBLISHED.

RELEASED FOR PUBLICATION

© COPYRIGHT - BY TYCO ELECTRONICS CORPORATION. ALL RIGHTS RESERVED.

LOC	DIST	REVISIONS					
		P	LTR	DESCRIPTION	DATE	DWN	APVD
		-		SEE SHEET 1	-	-	-

DIMENSIONS AFTER STACKING

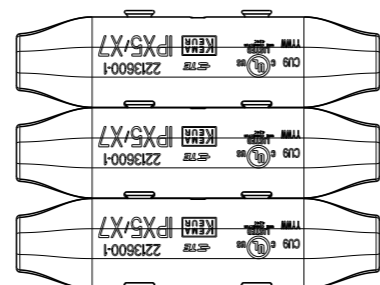
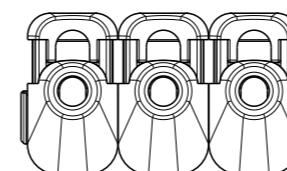
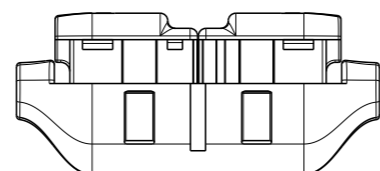
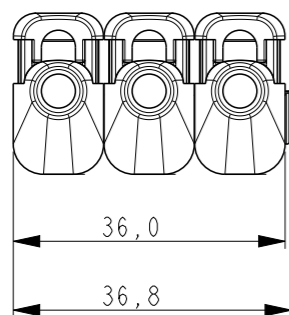
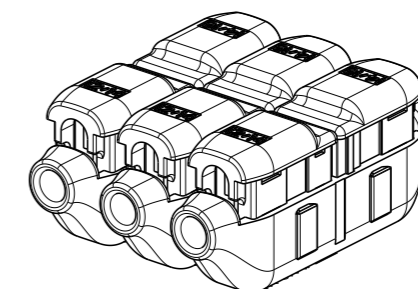
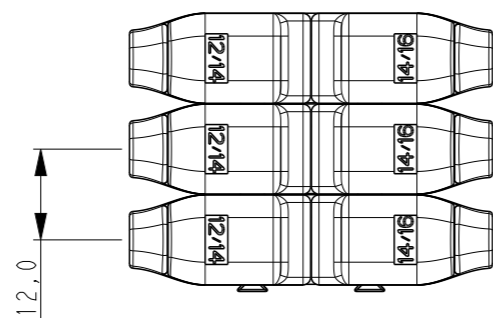

THIS DRAWING IS A CONTROLLED DOCUMENT.		DWN M.V.ESSSEN 06 NOV '15	 TE Connectivity		
DIMENSIONS: mm		CHK C.V.STEENDEREN			
TOLERANCES UNLESS OTHERWISE SPECIFIED:		APVD O.IEIJNSE	NAME COOL SPLICE ONE POSITION LARGE WIRE GAUGE		
<ul style="list-style-type: none"> 0 PLC ±- 1 PLC ±0,2 2 PLC ±0,2 3 PLC ±- 4 PLC ±- ANGLES ±- 		PRODUCT SPEC 108-133061	RESTRICTED TO		
MATERIAL		APPLICATION SPEC 114-133061	SIZE A3	CAGE CODE 00779	DRAWING NO C-2213600
FINISH		WEIGHT	SCALE 1:1		
		CUSTOMER DRAWING	SHEET 3 OF 3		
			REV A1		