

2.0 inch (50.80mm)

5X7 DOT MATRIX LED DISPLAY UVP-2X57A SERIES

DESCRIPTION

The UVP-2057/2157 is 2.0 inch (50.80mm) height 5X7 dot matrix display.

Single color display have the of choices of three bright colors-AlGaAs red/green/red orange.

Multicolor display are applicable to two colors : green and red orange.

All device have gray face and white dot.

The AlGaAs red LED chip are made from AlGaAs on a non-transparent GaAs substrate.

The green LED chip are made from GaP on a transparent GaP substrate.

The red orange LED chip are made from GaAsP on a transparent GaP substrate.

FEATURES

- Industry standard size
- Wide viewing angle
- Continuous uniform dot matrix.
- Excellent characters appearance
- Low power requirement

DEVICES

PART NO.	DESCRIPTION	PACKAGE DIMENSION	INTERNAL CIRCUIT DIAGRAM
UVP-2057A	Column Anode	Fig. 1	Fig. 2
UVP-2157A	Column Cathode		

ABSOLUTE MAXIMUM RATINGS

@ T_A=25°C

PARAMETER	AlGaAs RED	GREEN	RED ORANGE	UNIT
Power Dissipation Per Dot	36	36	36	mW
Peak Forward Current Per Dot	125	100	100	mA
Continuous Forward Current Per Dot	15	13	13	mA
Derating Linear From 25°C Per Dot	0.20	0.17	0.17	mA/°C
Reverse Voltage Per Dot	5	5	5	V
Operating Temperature Range	-35°Cto+85°C			
Storage Temperature Range	-35°Cto+85°C			
Solder Temperature 1/16 inch Below Seating Plane for 3 Seconds at 260°C				



2.0 inch (50.80mm)

5X7 DOT MATRIX LED DISPLAY

UVP-2X57A SERIES

TYPICAL ELECTRICAL/OPTICAL CHARACTERISTIC CURVES

(Ambient Temperature =25°C Unless Otherwise Noted)

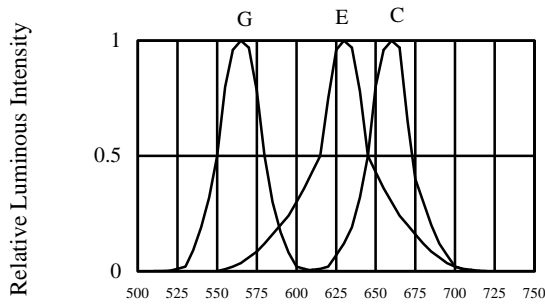

FIG.1 RELATIVE LUMINOUS INTENSITY VS. WAVELENGTH

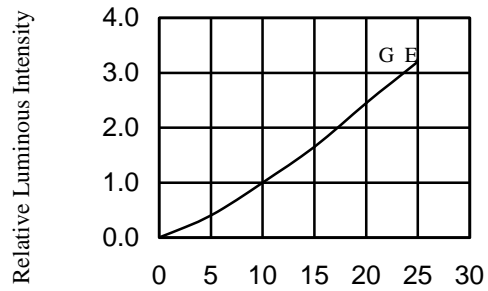

FIG.2 RELATIVE LUMINOUS INTENSITY VS. FORWARD CURRENT

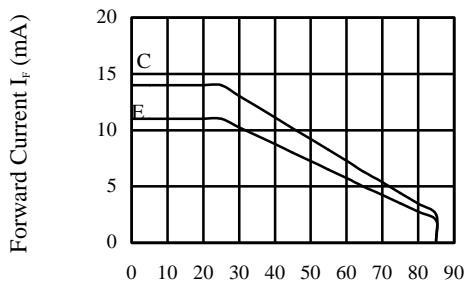

FIG.3 ALLOWABLE DC CURRENT VS. AMBIENT TEMPERATURE

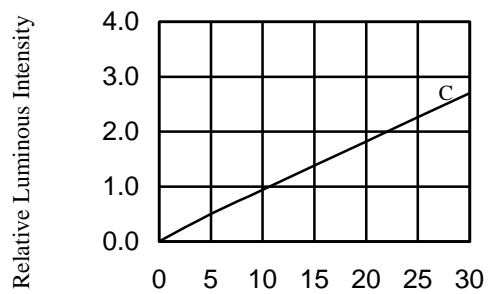

FIG.2 RELATIVE LUMINOUS INTENSITY VS. FORWARD CURRENT

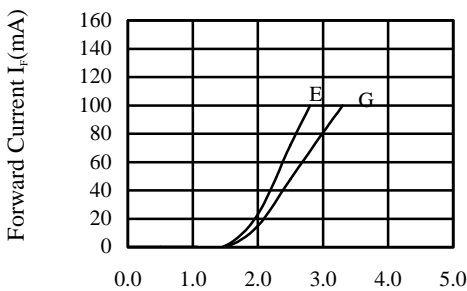

FIG.4 FORWARD CURRENT VS. FORWARD VOLTAGE

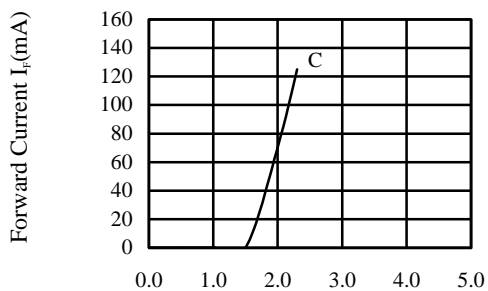

FIG.4 FORWARD CURRENT VS. FORWARD VOLTAGE



2.0 inch (50.80mm)

5X7 DOT MATRIX LED DISPLAY

UVP-2X57A SERIES

PACKAGE DIMENSIONS

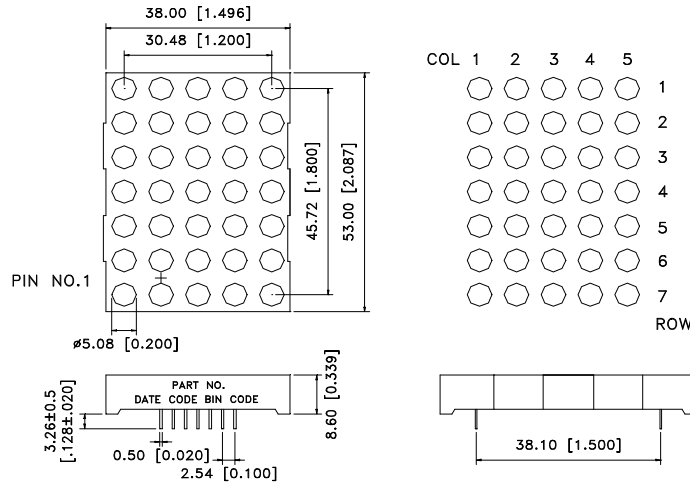

Unit:mm(inches)
Tolerance is ± 0.25mm(0.01")unless otherwise noted

Fig. 1

INTERNAL CIRCUIT DIAGRAM

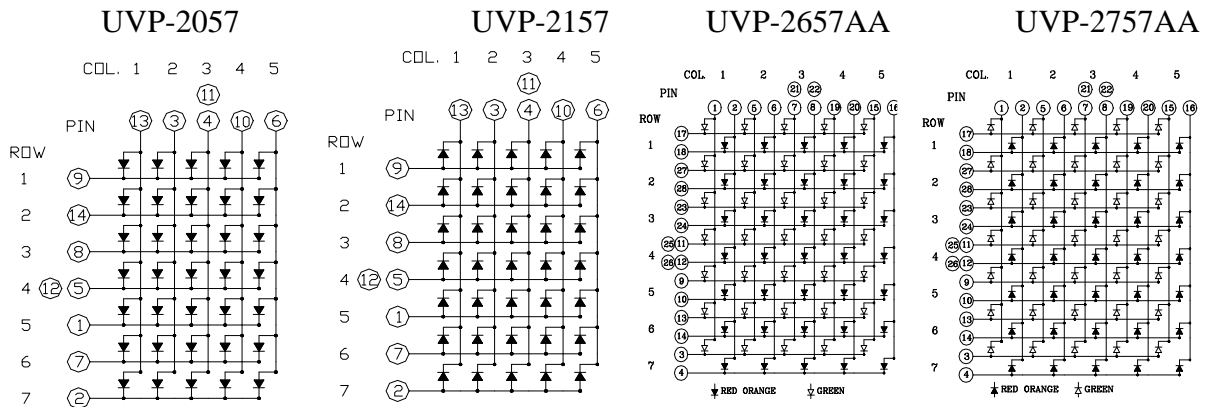

Fig. 2

2.0 inch (50.80mm)

5X7 DOT MATRIX LED DISPLAY

UVP-2X57A SERIES

PIN CONNECTION

Pin No.	CONNECTION	
	UVP-2657AA	UVP-2757AA
1	ANODE COLUMN 1 GREEN	CATHODE COLUMN 1 GREEN
2	ANODE COLUMN 1 RED ORANGE	CATHODE COLUMN 1 RED ORANGE
3	CATHODE ROW 7 GREEN	ANODE ROW 7 GREEN
4	CATHODE ROW 7 RED ORANGE	ANODE ROW 7 RED ORANGE
5	ANODE COLUMN 2 GREEN	CATHODE COLUMN 2 GREEN
6	ANODE COLUMN 2 RED ORANGE	CATHODE COLUMN 2 RED ORANGE
7	ANODE COLUMN 3 GREEN	CATHODE COLUMN 3 GREEN
8	ANODE COLUMN 3 RED ORANGE	CATHODE COLUMN 3 RED ORANGE
9	CATHODE ROW 5 GREEN	ANODE ROW 5 GREEN
10	CATHODE ROW 5 RED ORANGE	ANODE ROW 5 RED ORANGE
11	CATHODE ROW 4 GREEN	ANODE ROW 4 GREEN
12	CATHODE ROW 4 RED ORANGE	ANODE ROW 4 RED ORANGE
13	CATHODE ROW 6 GREEN	ANODE ROW 6 GREEN
14	CATHODE ROW 6 RED ORANGE	ANODE ROW 6 RED ORANGE
15	ANODE COLUMN 5 GREEN	CATHODE COLUMN 5 GREEN
16	ANODE COLUMN 5 RED ORANGE	CATHODE COLUMN 5 RED ORANGE
17	CATHODE ROW 1 GREEN	ANODE ROW 1 GREEN
18	CATHODE ROW 1 RED ORANGE	ANODE ROW 1 RED ORANGE
19	ANODE COLUMN 4 GREEN	CATHODE COLUMN 4 GREEN
20	ANODE COLUMN 4 RED ORANGE	CATHODE COLUMN 4 RED ORANGE
21	ANODE COLUMN 3 GREEN	CATHODE COLUMN 3 GREEN
22	ANODE COLUMN 3 RED ORANGE	CATHODE COLUMN 3 RED ORANGE
23	CATHODE ROW 3 GREEN	ANODE ROW 3 GREEN
24	CATHODE ROW 3 RED ORANGE	ANODE ROW 3 RED ORANGE
25	CATHODE ROW 4 GREEN	ANODE ROW 4 GREEN
26	CATHODE ROW 4 RED ORANGE	ANODE ROW 4 RED ORANGE
27	CATHODE ROW 2 GREEN	ANODE ROW 2 GREEN
28	CATHODE ROW 2 RED ORANGE	ANODE ROW 2 RED ORANGE

Pin No.	CONNECTION	
	UVP-2057	UVP-2157
1	CATHODE ROW 5	ANODE ROW 5
2	CATHODE ROW 7	ANODE ROW 7
3	ANODE COL. 2	CATHODE COL. 2
4	ANODE COL. 3*1	CATHODE COL. 3*1
5	CATHODE ROW 4*2	ANODE ROW 4*2
6	ANODE COL. 5	CATHODE COL. 5
7	CATHODE ROW 6	ANODE ROW 6
8	CATHODE ROW 3	ANODE ROW 3
9	CATHODE ROW 1	ANODE ROW 1
10	ANODE COL. 4	CATHODE COL. 4
11	ANODE COL. 3*1	CATHODE COL. 3*1
12	CATHODE ROW 4*2	ANODE ROW 4*2
13	ANODE COL. 1	CATHODE COL. 1
14	CATHODE ROW 2	ANODE ROW 2



2.0 inch (50.80mm)

5X7 DOT MATRIX LED DISPLAY

UVP-2X57A SERIES

ELECTRICAL/OPTICAL CHARACTERISTICS

AIGaAs RED (UVP-2057AC/2157AC)

@ T_A=25°C

PARAMETER	SYMBOL	MIN.	TYP.	MAX.	UNIT	TEST CONDITION
Average Luminous Intensity	I _V	6300	12000		μcd	I _p = 80 mA 1/16 Duty
Peak Emission Wavelength	λ _p /Hue		660/638		nm	I _F = 20 mA
Spectral Line Half-Width	Δλ		35		nm	I _F = 20 mA
Forward Voltage, any Dot	V _F		1.8	2.4	V	I _F = 20 mA
Reverse Current, any Dot	I _R			100	μA	V _R = 5 V
Luminous Intensity Matching Ratio	I _V -m			2:1		I _F = 10 mA

GREEN (UVP-2057AG/2157AG) & (UVP-2657AA/2757AA GREEN)

@ T_A=25°C

PARAMETER	SYMBOL	MIN.	TYP.	MAX.	UNIT	TEST CONDITION
Average Luminous Intensity	I _V	1780	4800		μcd	I _p = 80 mA 1/16 Duty
Peak Emission Wavelength	λ _p /Hue		565/569		nm	I _F = 20 mA
Spectral Line Half-Width	Δλ		30		nm	I _F = 20 mA
Forward Voltage, any Dot	V _F		2.1	2.6	V	I _F = 20 mA
Reverse Current, any Dot	I _R			100	μA	V _R = 5 V
Luminous Intensity Matching Ratio	I _V -m			2:1		I _F = 10 mA

RED ORANGE (UVP-2057E/2157E)&(UVP-2657AA/2757AA RED ORANGE)

@ T_A=25°C

PARAMETER	SYMBOL	MIN.	TYP.	MAX.	UNIT	TEST CONDITION
Average Luminous Intensity	I _V	3000	9600		μcd	I _p = 80 mA 1/16 Duty
Peak Emission Wavelength	λ _p /Hue		630/621		nm	I _F = 20 mA
Spectral Line Half-Width	Δλ		35		nm	I _F = 20 mA
Forward Voltage, any Dot	V _F		2.0	2.6	V	I _F = 20 mA
Reverse Current, any Dot	I _R			100	μA	V _R = 5 V
Luminous Intensity Matching Ratio	I _V -m			2:1		I _F = 10 mA