

IRLS4030PbF IRLSL4030PbF

HEXFET® Power MOSFET

Applications

- DC Motor Drive
- High Efficiency Synchronous Rectification in SMPS
- Uninterruptible Power Supply
- High Speed Power Switching
- Hard Switched and High Frequency Circuits

Benefits

- Optimized for Logic Level Drive
- Very Low $R_{DS(ON)}$ at 4.5V V_{GS}
- Superior R^*Q at 4.5V V_{GS}
- Improved Gate, Avalanche and Dynamic dV/dt Ruggedness
- Fully Characterized Capacitance and Avalanche SOA
- Enhanced body diode dV/dt and dI/dt Capability
- Lead-Free

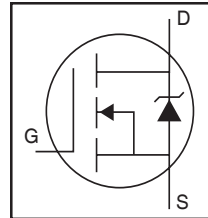

| | | |
|--------------|------|--------------|
| V_{DSS} | | 100V |
| $R_{DS(on)}$ | typ. | 3.4mΩ |
| | max. | 4.3mΩ |
| I_D | | 180A |

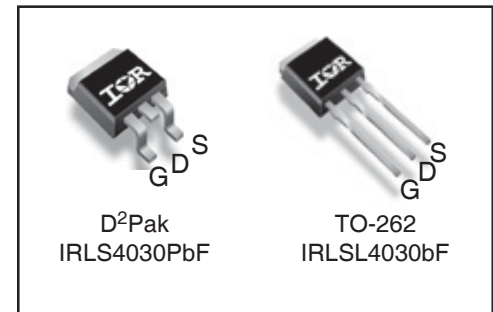

| | | |
|----------|----------|----------|
| G | D | S |
| Gate | Drain | Source |

Absolute Maximum Ratings

| Symbol | Parameter | Max. | Units |
|---------------------------------|--|--------------|-------|
| $I_D @ T_C = 25^\circ\text{C}$ | Continuous Drain Current, $V_{GS} @ 10\text{V}$ | 180 | A |
| $I_D @ T_C = 100^\circ\text{C}$ | Continuous Drain Current, $V_{GS} @ 10\text{V}$ | 130 | |
| I_{DM} | Pulsed Drain Current ① | 730 | |
| $P_D @ T_C = 25^\circ\text{C}$ | Maximum Power Dissipation | 370 | W |
| | Linear Derating Factor | 2.5 | W/°C |
| V_{GS} | Gate-to-Source Voltage | ± 16 | V |
| dv/dt | Peak Diode Recovery ③ | 21 | V/ns |
| T_J | Operating Junction and | -55 to + 175 | °C |
| T_{STG} | Storage Temperature Range | | |
| | Soldering Temperature, for 10 seconds (1.6mm from case) | | |

Avalanche Characteristics

| | | | |
|------------------------------|---------------------------------|---------------------------|----|
| E_{AS} (Thermally limited) | Single Pulse Avalanche Energy ② | 305 | mJ |
| I_{AR} | Avalanche Current ① | See Fig. 14, 15, 22a, 22b | A |
| E_{AR} | Repetitive Avalanche Energy ④ | | mJ |

Thermal Resistance

| Symbol | Parameter | Typ. | Max. | Units |
|-----------------|------------------------------------|------|------|-------|
| $R_{\theta JC}$ | Junction-to-Case ⑥⑦ | — | 0.40 | °C/W |
| $R_{\theta JA}$ | Junction-to-Ambient (PCB Mount) ⑦⑧ | — | 40 | |

Static @ $T_J = 25^\circ\text{C}$ (unless otherwise specified)

| Symbol | Parameter | Min. | Typ. | Max. | Units | Conditions |
|---------------------------------|--------------------------------------|------|------|------|---------------------|---|
| $V_{(BR)DSS}$ | Drain-to-Source Breakdown Voltage | 100 | — | — | V | $V_{GS} = 0V, I_D = 250\mu A$ |
| $\Delta V_{(BR)DSS}/\Delta T_J$ | Breakdown Voltage Temp. Coefficient | — | 0.10 | — | V/ $^\circ\text{C}$ | Reference to $25^\circ\text{C}, I_D = 5mA$ ① |
| $R_{DS(on)}$ | Static Drain-to-Source On-Resistance | — | 3.4 | 4.3 | m Ω | $V_{GS} = 10V, I_D = 110A$ ④ |
| | | — | 3.6 | 4.5 | | $V_{GS} = 4.5V, I_D = 92A$ ④ |
| $V_{GS(th)}$ | Gate Threshold Voltage | 1.0 | — | 2.5 | V | $V_{DS} = V_{GS}, I_D = 250\mu A$ |
| I_{DSS} | Drain-to-Source Leakage Current | — | — | 20 | μA | $V_{DS} = 100V, V_{GS} = 0V$ |
| | | — | — | 250 | | $V_{DS} = 100V, V_{GS} = 0V, T_J = 125^\circ\text{C}$ |
| I_{GSS} | Gate-to-Source Forward Leakage | — | — | 100 | nA | $V_{GS} = 16V$ |
| | Gate-to-Source Reverse Leakage | — | — | -100 | | $V_{GS} = -16V$ |
| $R_{G(int)}$ | Internal Gate Resistance | — | 2.1 | — | Ω | |

Dynamic @ $T_J = 25^\circ\text{C}$ (unless otherwise specified)

| Symbol | Parameter | Min. | Typ. | Max. | Units | Conditions |
|----------------------|--|------|-------|------|-------|--|
| gfs | Forward Transconductance | 320 | — | — | S | $V_{DS} = 25V, I_D = 110A$ |
| Q_g | Total Gate Charge | — | 87 | 130 | nC | $I_D = 110A$ |
| Q_{gs} | Gate-to-Source Charge | — | 27 | — | | $V_{DS} = 50V$ |
| Q_{gd} | Gate-to-Drain ("Miller") Charge | — | 45 | — | | $V_{GS} = 4.5V$ ④ |
| Q_{sync} | Total Gate Charge Sync. ($Q_g - Q_{gd}$) | — | 42 | — | | $I_D = 110A, V_{DS} = 0V, V_{GS} = 4.5V$ |
| $t_{d(on)}$ | Turn-On Delay Time | — | 74 | — | ns | $V_{DD} = 65V$ |
| t_r | Rise Time | — | 330 | — | | $I_D = 110A$ |
| $t_{d(off)}$ | Turn-Off Delay Time | — | 110 | — | | $R_G = 2.7\Omega$ |
| t_f | Fall Time | — | 170 | — | | $V_{GS} = 4.5V$ ④ |
| C_{iss} | Input Capacitance | — | 11360 | — | pF | $V_{GS} = 0V$ |
| C_{oss} | Output Capacitance | — | 670 | — | | $V_{DS} = 50V$ |
| C_{riss} | Reverse Transfer Capacitance | — | 290 | — | | $f = 1.0MHz$ |
| $C_{oss\ eff. (ER)}$ | Effective Output Capacitance (Energy Related)⑥ | — | 760 | — | | $V_{GS} = 0V, V_{DS} = 0V \text{ to } 80V$ ⑥ |
| $C_{oss\ eff. (TR)}$ | Effective Output Capacitance (Time Related)⑤ | — | 1140 | — | | $V_{GS} = 0V, V_{DS} = 0V \text{ to } 80V$ ⑤ |

Diode Characteristics

| Symbol | Parameter | Min. | Typ. | Max. | Units | Conditions |
|-----------|---|--|------|------|-------|---|
| I_S | Continuous Source Current (Body Diode) | — | — | 180 | A | MOSFET symbol showing the integral reverse p-n junction diode. |
| I_{SM} | Pulsed Source Current (Body Diode) ① | — | — | 730 | | |
| V_{SD} | Diode Forward Voltage | — | — | 1.3 | V | $T_J = 25^\circ\text{C}, I_S = 110A, V_{GS} = 0V$ ④ |
| t_{rr} | Reverse Recovery Time | — | 50 | — | ns | $T_J = 25^\circ\text{C}$ $V_R = 85V,$ |
| | | — | 60 | — | | $T_J = 125^\circ\text{C}$ $I_F = 110A$ |
| Q_{rr} | Reverse Recovery Charge | — | 88 | — | nC | $T_J = 25^\circ\text{C}$ $di/dt = 100A/\mu s$ ④ |
| | | — | 130 | — | | $T_J = 125^\circ\text{C}$ |
| I_{RRM} | Reverse Recovery Current | — | 3.3 | — | A | $T_J = 25^\circ\text{C}$ |
| t_{on} | Forward Turn-On Time | Intrinsic turn-on time is negligible (turn-on is dominated by LS+LD) | | | | |

Notes:

- ① Repetitive rating; pulse width limited by max. junction temperature.
- ② Limited by T_{Jmax} , starting $T_J = 25^\circ\text{C}$, $L = 0.05mH$
 $R_G = 25\Omega, I_{AS} = 110A, V_{GS} = 10V$. Part not recommended for use above this value.
- ③ $I_{SD} \leq 110A, di/dt \leq 1330A/\mu s, V_{DD} \leq V_{(BR)DSS}, T_J \leq 175^\circ\text{C}$.
- ④ Pulse width $\leq 400\mu s$; duty cycle $\leq 2\%$.

- ⑤ $C_{oss\ eff. (TR)}$ is a fixed capacitance that gives the same charging time as C_{oss} while V_{DS} is rising from 0 to 80% V_{DSS} .
- ⑥ $C_{oss\ eff. (ER)}$ is a fixed capacitance that gives the same energy as C_{oss} while V_{DS} is rising from 0 to 80% V_{DSS} .
- ⑦ When mounted on 1" square PCB (FR-4 or G-10 Material). For recommended footprint and soldering techniques refer to application note # AN-994.
- ⑧ R_θ is measured at T_J approximately 90°C .
- ⑨ $R_{\theta JC}$ value shown is at time zero.

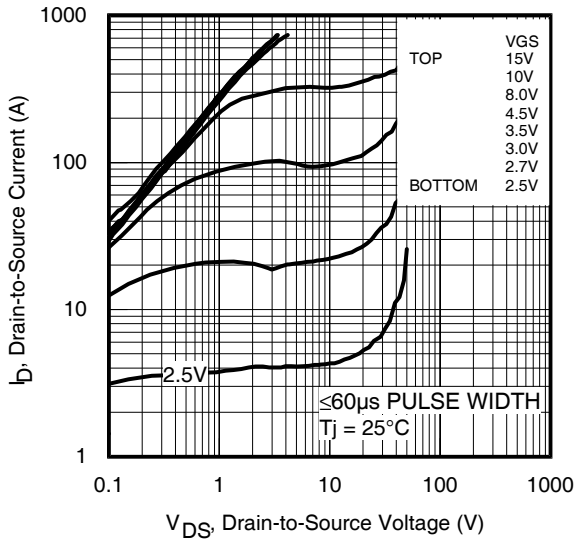

Fig 1. Typical Output Characteristics

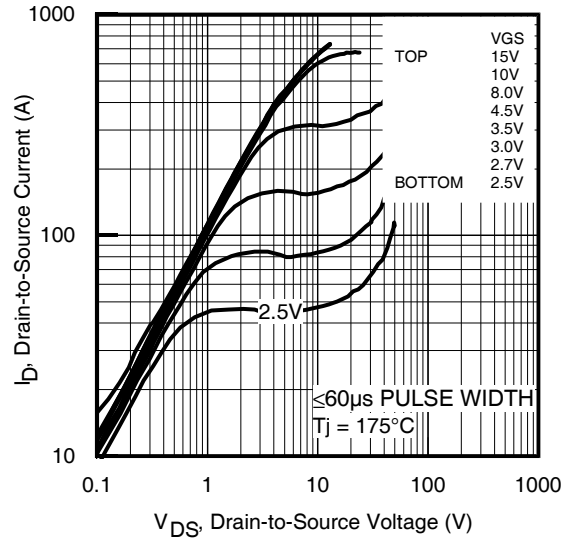

Fig 2. Typical Output Characteristics

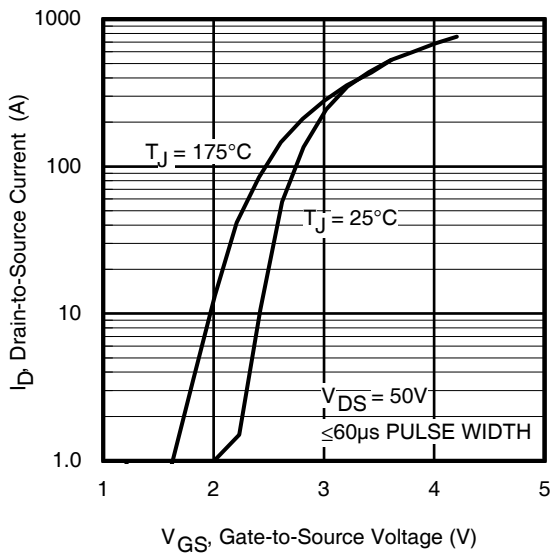

Fig 3. Typical Transfer Characteristics

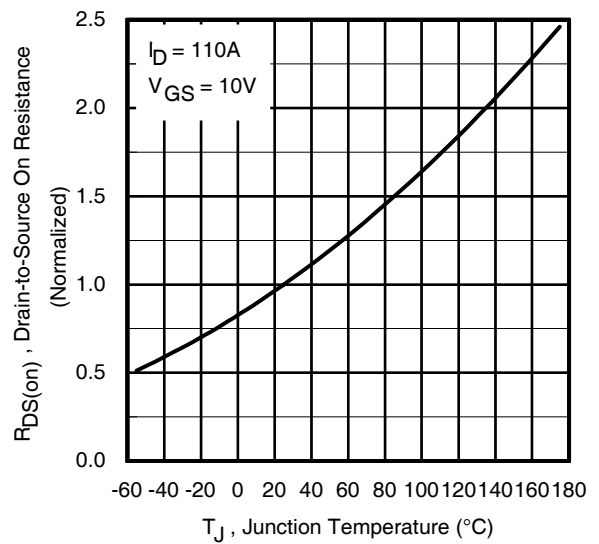

Fig 4. Normalized On-Resistance vs. Temperature

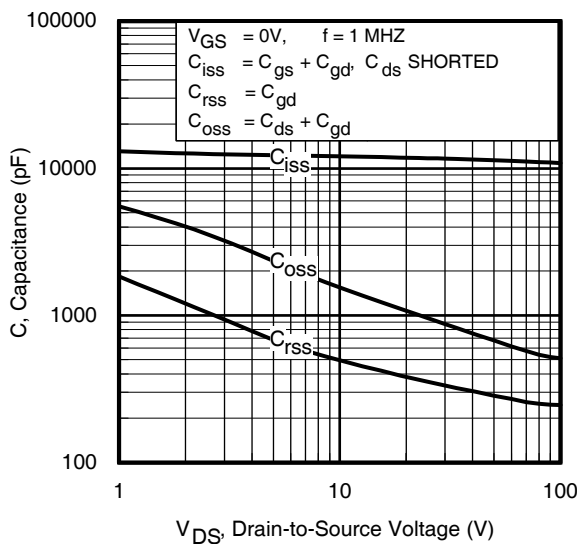

Fig 5. Typical Capacitance vs. Drain-to-Source Voltage

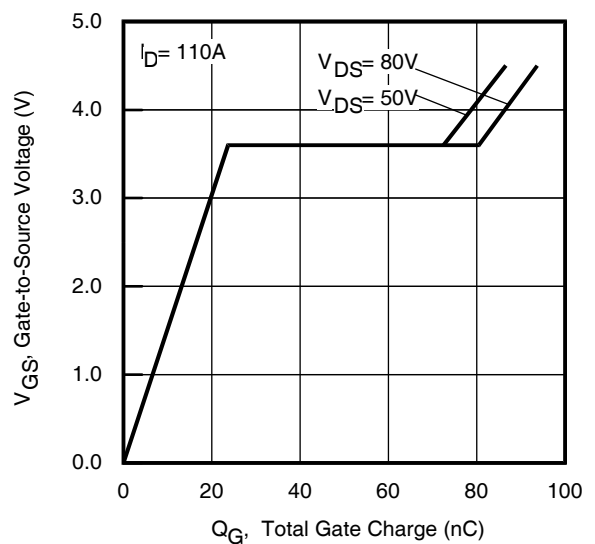

Fig 6. Typical Gate Charge vs. Gate-to-Source Voltage

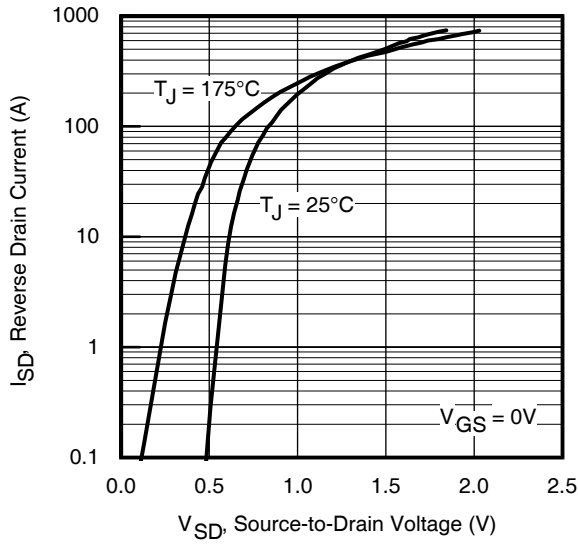

Fig 7. Typical Source-Drain Diode Forward Voltage

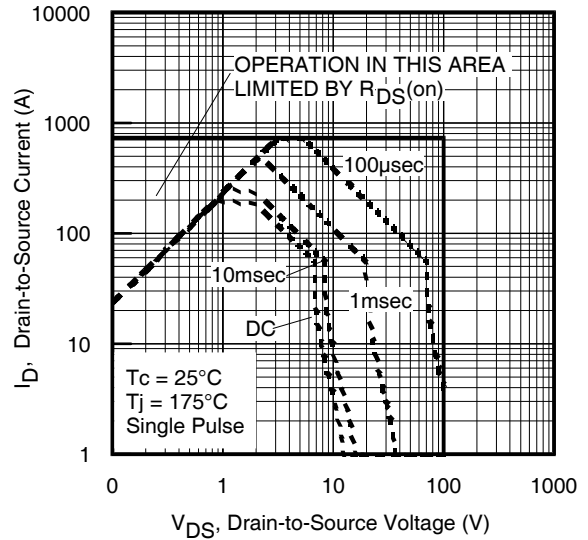

Fig 8. Maximum Safe Operating Area

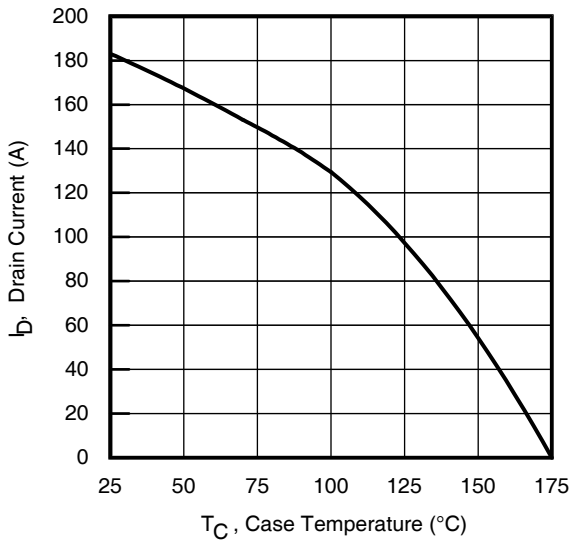

Fig 9. Maximum Drain Current vs. Case Temperature

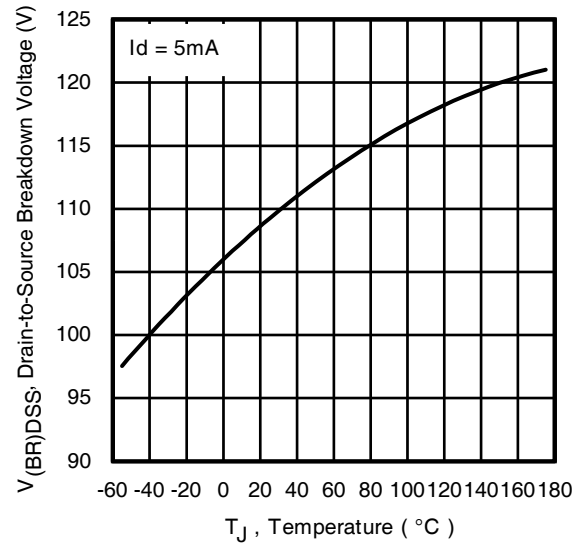

Fig 10. Drain-to-Source Breakdown Voltage

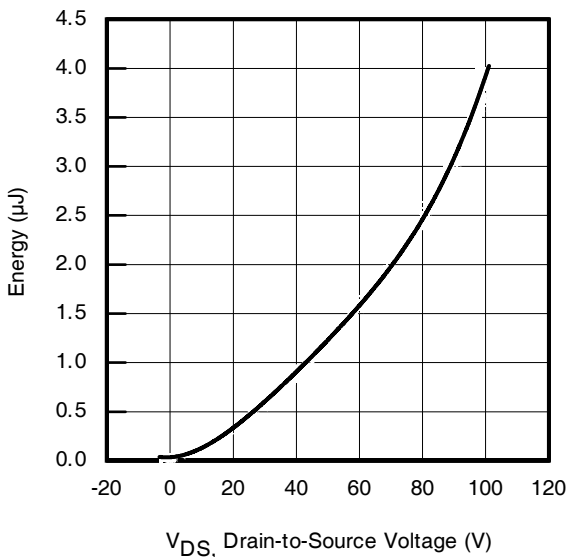

Fig 11. Typical C_{OSS} Stored Energy

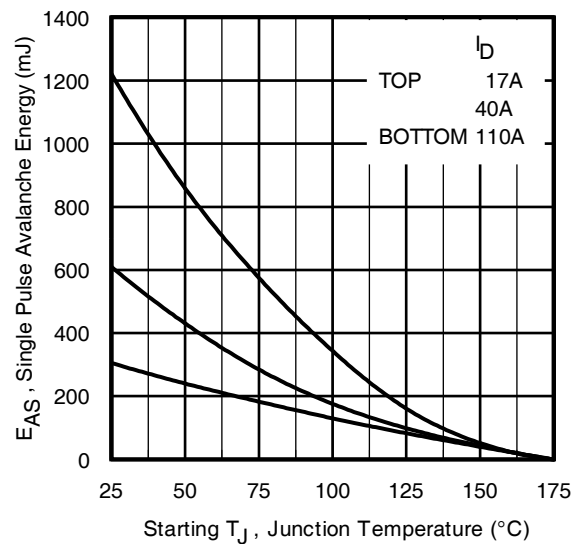

Fig 12. Maximum Avalanche Energy vs. Drain Current

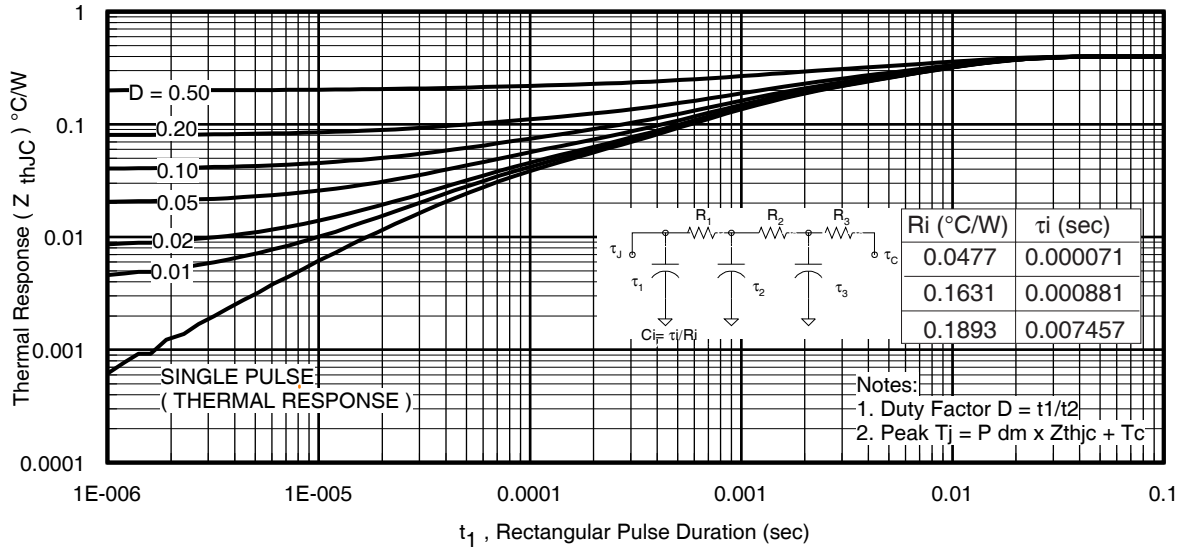

Fig 13. Maximum Effective Transient Thermal Impedance, Junction-to-Case

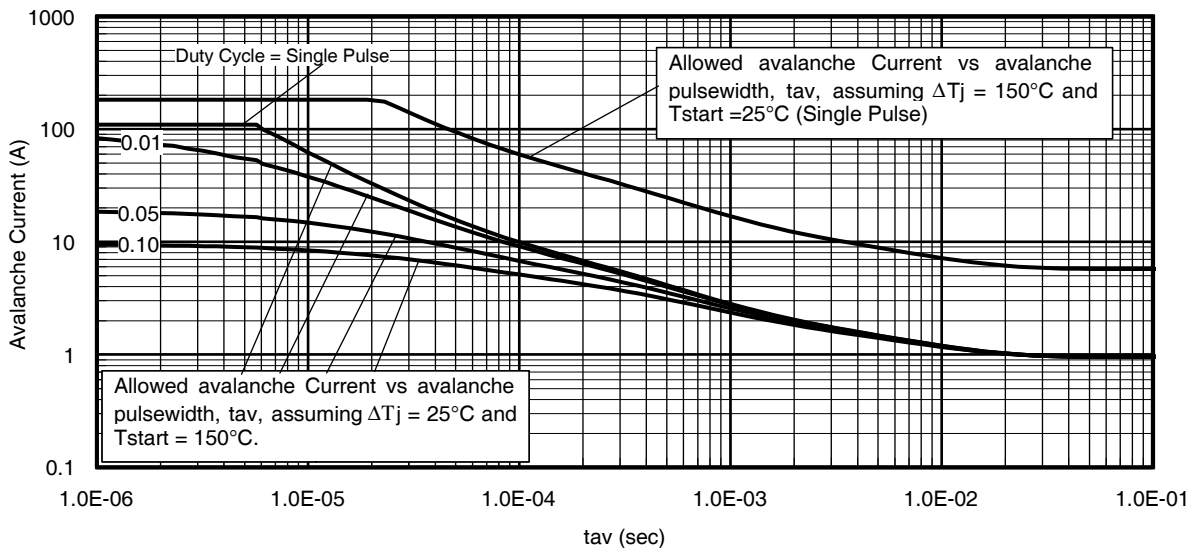
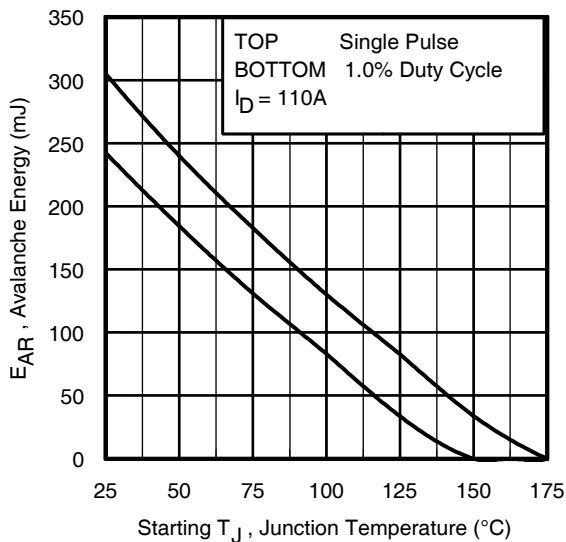

Fig 14. Typical Avalanche Current vs. Pulsewidth



Notes on Repetitive Avalanche Curves, Figures 14, 15:
(For further info, see AN-1005 at www.irf.com)

1. Avalanche failures assumption:
Purely a thermal phenomenon and failure occurs at a temperature far in excess of T_{jmax} . This is validated for every part type.
2. Safe operation in Avalanche is allowed as long as T_{jmax} is not exceeded.
3. Equation below based on circuit and waveforms shown in Figures 16a, 16b.
4. $P_{D(ave)}$ = Average power dissipation per single avalanche pulse.
5. BV = Rated breakdown voltage (1.3 factor accounts for voltage increase during avalanche).
6. I_{av} = Allowable avalanche current.
7. ΔT = Allowable rise in junction temperature, not to exceed T_{jmax} (assumed as 25°C in Figure 14, 15).
 t_{av} = Average time in avalanche.
 D = Duty cycle in avalanche = $t_{av} \cdot f$
 $Z_{thJC}(D, t_{av})$ = Transient thermal resistance, see Figures 13)

$$P_{D(ave)} = 1/2 (1.3 \cdot BV \cdot I_{av}) = \Delta T / Z_{thJC}$$

$$I_{av} = 2\Delta T / [1.3 \cdot BV \cdot Z_{th}]$$

$$E_{AS(AR)} = P_{D(ave)} \cdot t_{av}$$

Fig 15. Maximum Avalanche Energy vs. Temperature

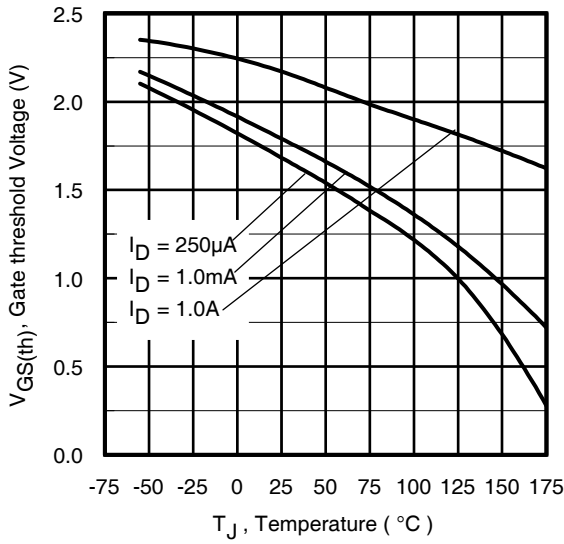

Fig 16. Threshold Voltage vs. Temperature

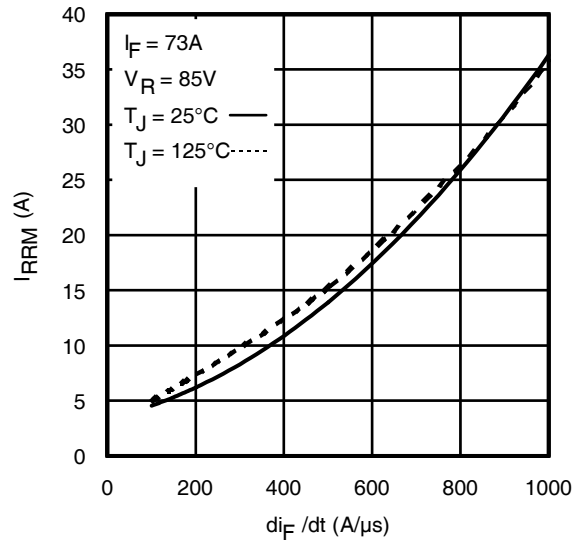

Fig. 17 - Typical Recovery Current vs. di_F/dt

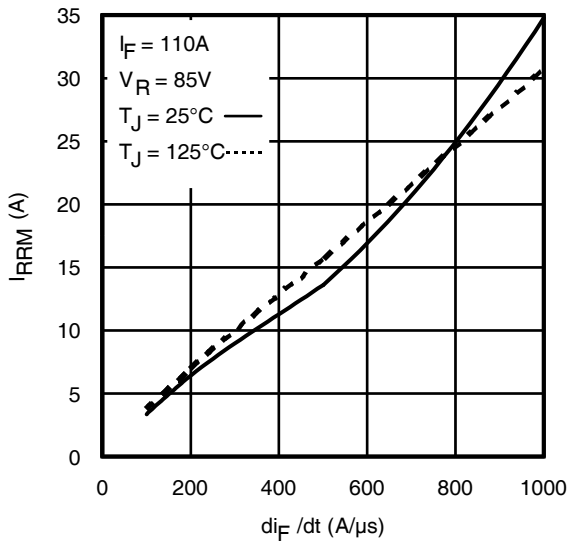

Fig. 18 - Typical Recovery Current vs. di_F/dt

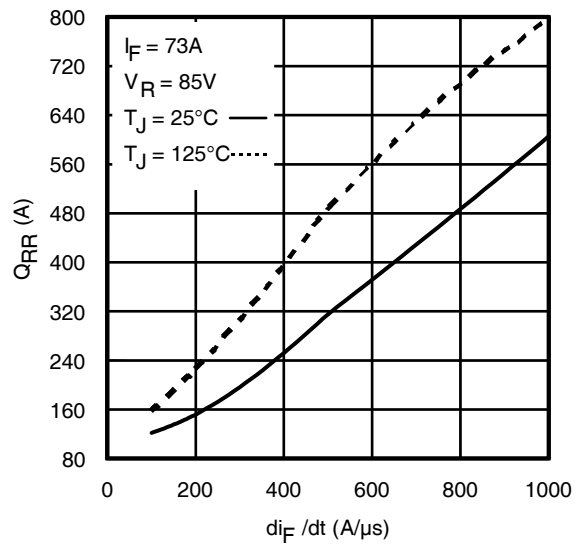

Fig. 19 - Typical Stored Charge vs. di_F/dt

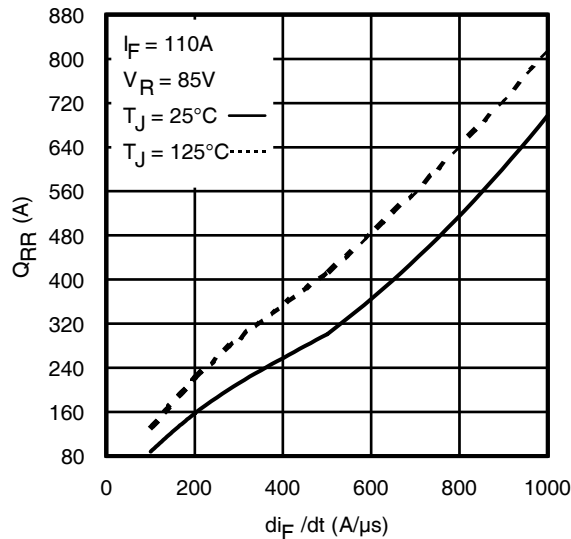
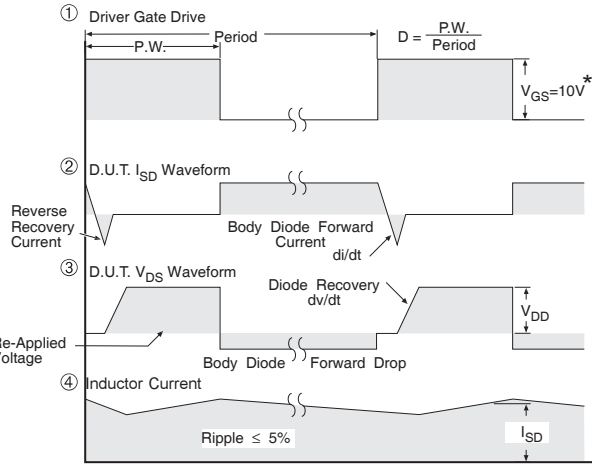
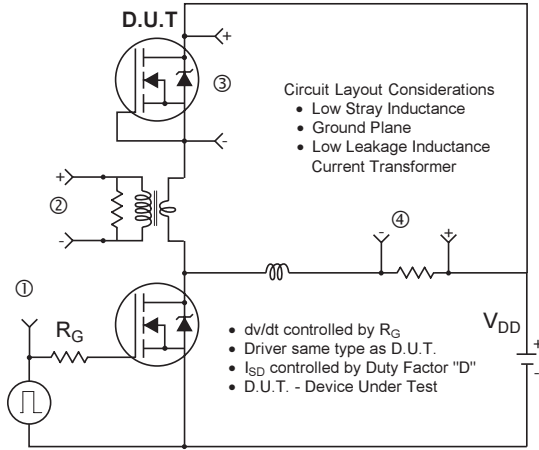

Fig. 20 - Typical Stored Charge vs. di_F/dt



* $V_{GS} = 5V$ for Logic Level Devices

Fig 21. Peak Diode Recovery dv/dt Test Circuit for N-Channel HEXFET[®] Power MOSFETs

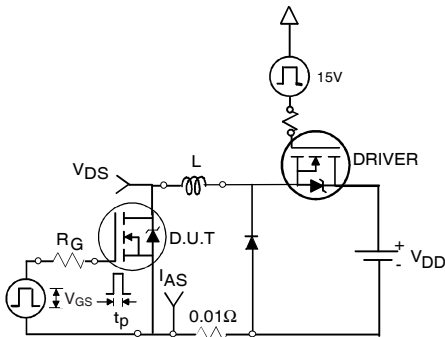

Fig 22a. Unclamped Inductive Test Circuit

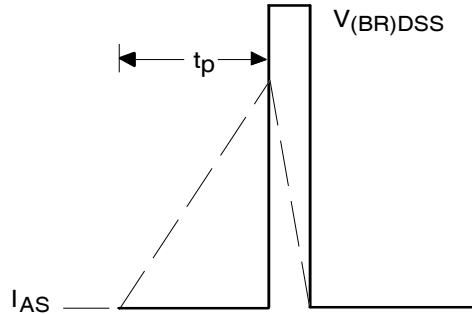

Fig 22b. Unclamped Inductive Waveforms

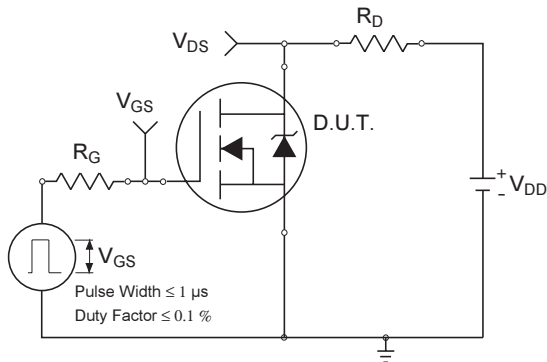

Fig 23a. Switching Time Test Circuit

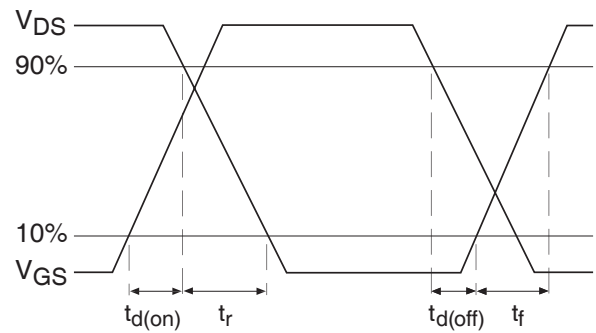

Fig 23b. Switching Time Waveforms

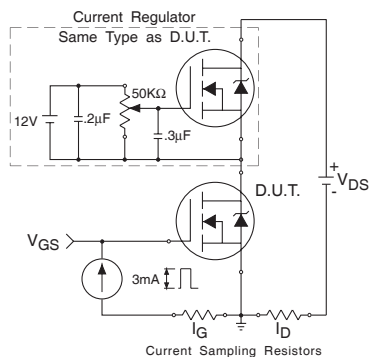

Fig 24a. Gate Charge Test Circuit

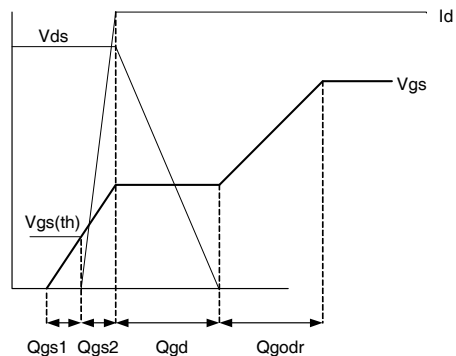
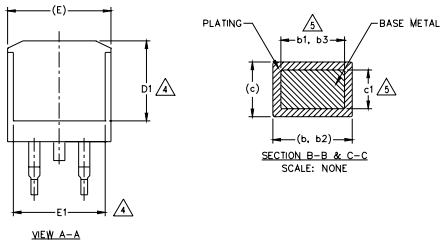
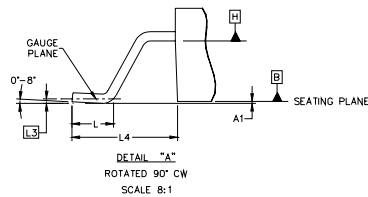
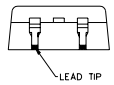
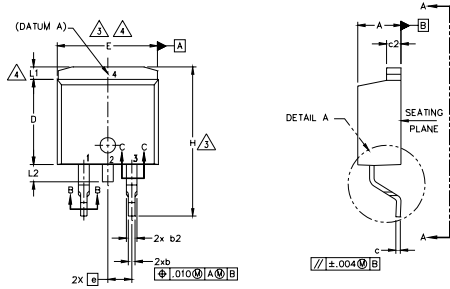

Fig 24b. Gate Charge Waveform

D²Pak (TO-263AB) Package Outline

Dimensions are shown in millimeters (inches)



LEAD ASSIGNMENTS

DIODES

- 1.- ANODE (TWO DIE) / OPEN (ONE DIE)
- 2. 4.- CATHODE
- 3.- ANODE

HEXFET

- 1.- GATE
- 2. 4.- DRAIN
- 3.- SOURCE

IGBTs, CoPACK

- 1.- GATE
- 2. 4.- COLLECTOR
- 3.- EMITTER

| SYMBOL | DIMENSIONS | | | | NOTES |
|--------|-------------|-------|----------|------|-------|
| | MILLIMETERS | | INCHES | | |
| | MIN. | MAX. | MIN. | MAX. | |
| A | 4.06 | 4.83 | .160 | .190 | |
| A1 | 0.00 | 0.254 | .000 | .010 | |
| b | 0.51 | 0.99 | .020 | .039 | |
| b1 | 0.51 | 0.89 | .020 | .035 | 5 |
| b2 | 1.14 | 1.78 | .045 | .070 | |
| b3 | 1.14 | 1.73 | .045 | .068 | 5 |
| c | 0.38 | 0.74 | .015 | .029 | |
| c1 | 0.38 | 0.58 | .015 | .023 | 5 |
| c2 | 1.14 | 1.65 | .045 | .065 | |
| D | 8.38 | 9.65 | .330 | .380 | 3 |
| D1 | 6.86 | - | .270 | - | 4 |
| E | 9.65 | 10.67 | .380 | .420 | 3,4 |
| E1 | 6.22 | - | .245 | - | 4 |
| e | 2.54 BSC | | .100 BSC | | |
| H | 14.61 | 15.88 | .575 | .625 | |
| L | 1.78 | 2.79 | .070 | .110 | |
| L1 | - | 1.65 | - | .066 | 4 |
| L2 | - | 1.78 | - | .070 | |
| L3 | 0.25 BSC | | .010 BSC | | |
| L4 | 4.78 | 5.28 | .188 | .208 | |

NOTES:

1. DIMENSIONING AND TOLERANCING PER ASME Y14.5M-1994
2. DIMENSIONS ARE SHOWN IN MILLIMETERS [INCHES].
3. DIMENSION D & E DO NOT INCLUDE MOLD FLASH. MOLD FLASH SHALL NOT EXCEED 0.127 [0.005"] PER SIDE. THESE DIMENSIONS ARE MEASURED AT THE OUTMOST EXTREMES OF THE PLASTIC BODY AT DATUM H.
4. THERMAL PAD CONTOUR OPTIONAL WITHIN DIMENSION E, L1, D1 & E1.
5. DIMENSION b1 AND c1 APPLY TO BASE METAL ONLY.
6. DATUM A & B TO BE DETERMINED AT DATUM PLANE H.
7. CONTROLLING DIMENSION: INCH.
8. OUTLINE CONFORMS TO JEDEC OUTLINE TO-263AB.

D²Pak (TO-263AB) Part Marking Information

EXAMPLE: THIS IS AN IRF530S WITH
LOT CODE 8024
ASSEMBLED ON WW 02, 2000
IN THE ASSEMBLY LINE "L"

Note: "P" in assembly line position
indicates "Lead - Free"

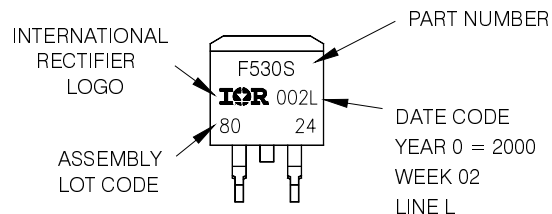

OR

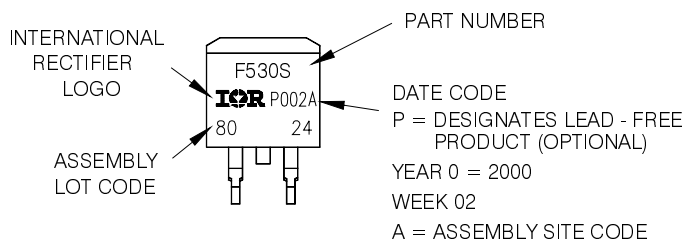

Note: For the most current drawing please refer to IR website at <http://www.irf.com/package/>

TO-262 Package Outline

Dimensions are shown in millimeters (inches)

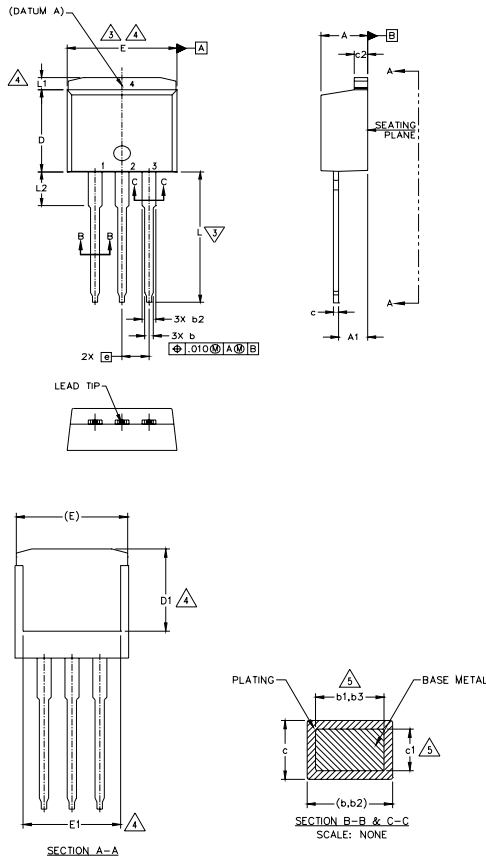

| SYMBOL | DIMENSIONS | | | | NOTES |
|--------|-------------|-------|----------|------|-------|
| | MILLIMETERS | | INCHES | | |
| | MIN. | MAX. | MIN. | MAX. | |
| A | 4.06 | 4.83 | .160 | .190 | |
| A1 | 2.03 | 3.02 | .080 | .119 | |
| b | 0.51 | 0.99 | .020 | .039 | |
| b1 | 0.51 | 0.89 | .020 | .035 | 5 |
| b2 | 1.14 | 1.78 | .045 | .070 | |
| b3 | 1.14 | 1.73 | .045 | .068 | 5 |
| c | 0.38 | 0.74 | .015 | .029 | |
| c1 | 0.38 | 0.58 | .015 | .023 | 5 |
| c2 | 1.14 | 1.65 | .045 | .065 | |
| D | 8.38 | 9.65 | .330 | .380 | 3 |
| D1 | 6.86 | — | .270 | — | 4 |
| E | 9.65 | 10.67 | .380 | .420 | 3,4 |
| E1 | 6.22 | — | .245 | — | 4 |
| e | 2.54 BSC | | .100 BSC | | |
| L | 13.46 | 14.10 | .530 | .555 | |
| L1 | — | 1.65 | — | .065 | 4 |
| L2 | 3.56 | 3.71 | .140 | .146 | |

- NOTES:
1. DIMENSIONING AND TOLERANCING PER ASME Y14.5M-1994
 2. DIMENSIONS ARE SHOWN IN MILLIMETERS (INCHES)
 3. DIMENSION D & E DO NOT INCLUDE MOLD FLASH. MOLD FLASH SHALL NOT EXCEED 0.127 [0.005] PER SIDE. THESE DIMENSIONS ARE MEASURED AT THE OUTMOST EXTREMES OF THE PLASTIC BODY.
 4. THERMAL PAD CONTOUR OPTIONAL WITHIN DIMENSION L, L1, D1 & E1.
 5. DIMENSION b1 AND c1 APPLY TO BASE METAL ONLY.
 6. CONTROLLING DIMENSIONS: INCH.
 7. — OUTLINE CONFORMS TO JEDEC TO-262 EXCEPT A1(max.), b1(min.), AND D1(min.) WHERE DIMENSIONS DERIVED THE ACTUAL PACKAGE OUTLINE.

LEAD ASSIGNMENTS

IGBTs: CoPACK

- 1- GATE
- 2- COLLECTOR
- 3- EMITTER
- 4- COLLECTOR

HEXFET

- 1- GATE
- 2- DRAIN
- 3- SOURCE
- 4- DRAIN

DIODES

- 1- ANODE (NO DE) / OPEN (ONE DE)
- 2- CATHODE
- 3- ANODE
- 4- DRAIN

TO-262 Part Marking Information

EXAMPLE: THIS IS AN IRL3103L
LOT CODE 1789
ASSEMBLED ON WW 19, 1997
IN THE ASSEMBLY LINE 'C'

Note: "P" in assembly line position indicates "Lead - Free"

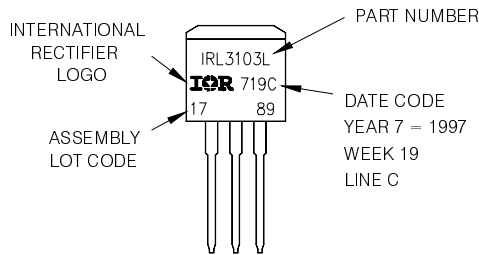

OR

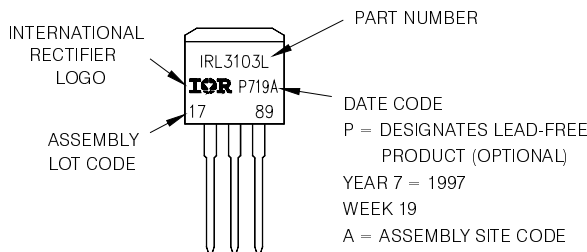

Note: For the most current drawing please refer to IR website at <http://www.irf.com/package/>
www.irf.com

D²Pak (TO-263AB) Tape & Reel Information

Dimensions are shown in millimeters (inches)

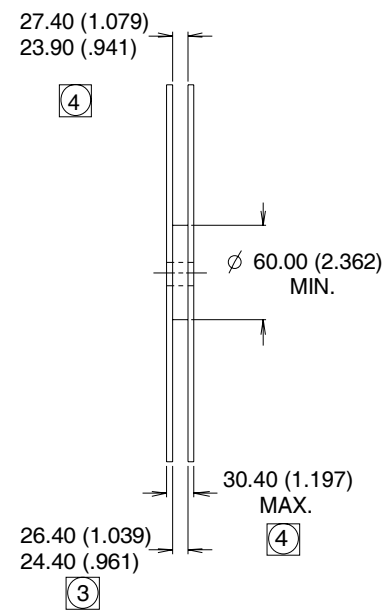
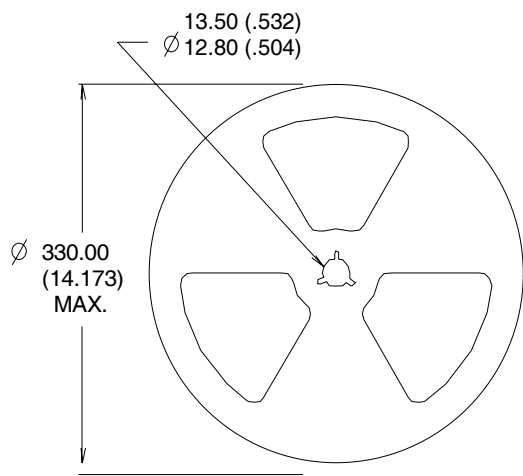
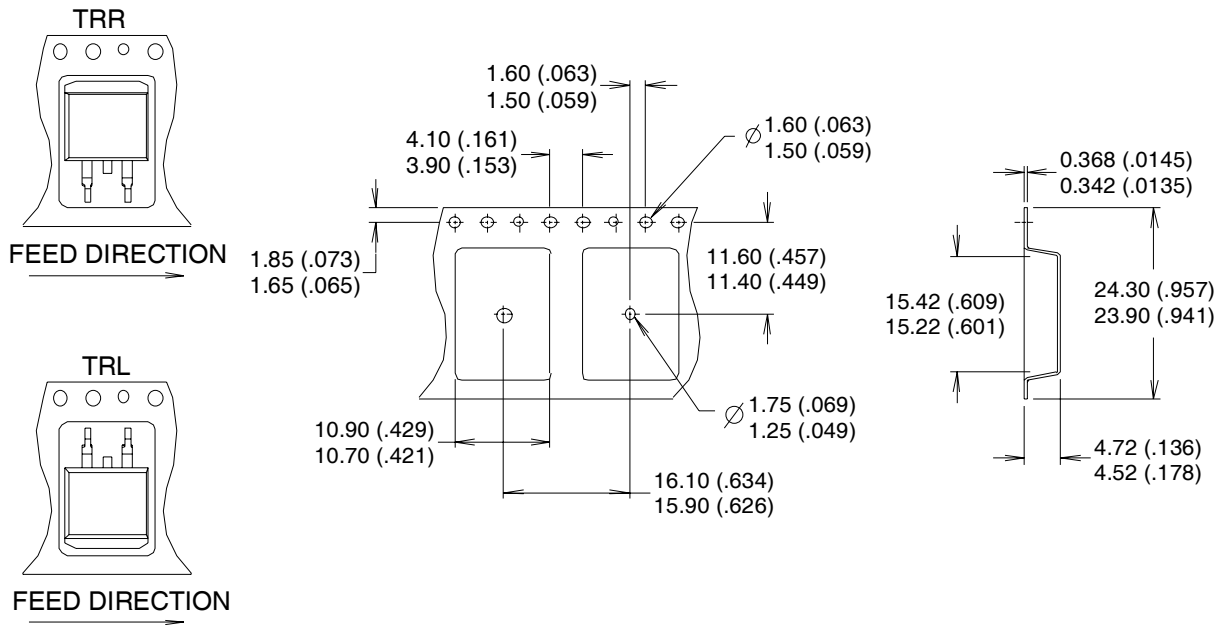

- NOTES :
1. CONFORMS TO EIA-418.
 2. CONTROLLING DIMENSION: MILLIMETER.
 - ③ DIMENSION MEASURED @ HUB.
 - ④ INCLUDES FLANGE DISTORTION @ OUTER EDGE.

Note: For the most current drawing please refer to IR website at <http://www.irf.com/package/>

Data and specifications subject to change without notice.
This product has been designed and qualified for the Industrial market.
Qualification Standards can be found on IR's Web site.