

MOSFET

Metal Oxide Semiconductor Field Effect Transistor

CoolMOS E6

650V CoolMOS™ E6 Power Transistor
IPx65R380E6

Data Sheet

Rev. 2.1, 2013-07-31
Final

Industrial & Multimarket

1 Description

CoolMOS™ is a revolutionary technology for high voltage power MOSFETs, designed according to the superjunction (SJ) principle and pioneered by Infineon Technologies. CoolMOS™ E6 series combines the experience of the leading SJ MOSFET supplier with high class innovation. The resulting devices provide all benefits of a fast switching SJ MOSFET while not sacrificing ease of use. Extremely low switching and conduction losses make switching applications even more efficient, more compact, lighter, and cooler.

Features

- Extremely low losses due to very low FOM $R_{DS(on)} \cdot Q_g$ and E_{oss}
- Very high commutation ruggedness
- Easy to use/drive
- JEDEC¹⁾ qualified, Pb-free plating, available in Halogen free mold compound²⁾

Applications

PFC stages, hard switching PWM stages and resonant switching PWM stages for e.g. PC Silverbox, Adapter, LCD & PDP TV, Lighting, Server, Telecom and UPS.

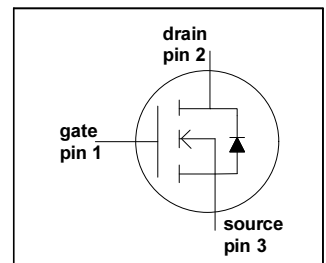
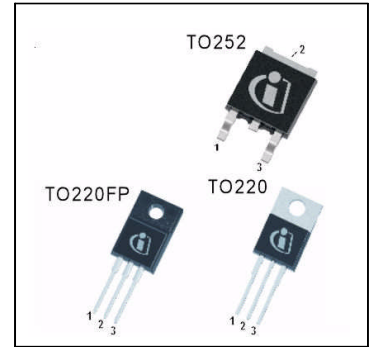

Please note: For MOSFET paralleling the use of ferrite beads on the gate or separate totem poles is generally recommended.



Table 1 Key Performance Parameters

Parameter	Value	Unit
$V_{DS} @ T_{j,max}$	700	V
$R_{DS(on),max}$	0.38	Ω
$Q_{g,typ}$	39	nC
$I_{D,pulse}$	29	A
$E_{oss} @ 400V$	2.8	μJ
Body diode di/dt	500	A/ μs

Type / Ordering Code	Package	Marking	Related Links
IPD65R380E6	PG-TO252	65E6380	IFX CoolMOS Webpage IFX Design tools
IPP65R380E6	PG-TO220		
IPA65R380E6	PG-TO220 FullPAK		

1) J-STD20 and JESD22

2) For PG-TO252: non-Halogen free (OPN: IPD65R380E6BT); Halogen free (OPN: IPD65R380E6AT)

Table of Contents

1	Description	2
	Table of Contents	3
2	Maximum ratings	4
3	Thermal characteristics	5
4	Electrical characteristics	6
5	Electrical characteristics diagrams	8
6	Test circuits	13
7	Package outlines	14
8	Revision History	17

2 Maximum ratings

at $T_j = 25\text{ °C}$, unless otherwise specified.

Table 2 Maximum ratings

Parameter	Symbol	Values			Unit	Note / Test Condition
		Min.	Typ.	Max.		
Continuous drain current ¹⁾	I_D	-	-	10.6	A	$T_C = 25\text{ °C}$
				6.7		$T_C = 100\text{ °C}$
Pulsed drain current ²⁾	$I_{D,pulse}$	-	-	29	A	$T_C = 25\text{ °C}$
Avalanche energy, single pulse	E_{AS}	-	-	215	mJ	$I_D = 1.8\text{ A}, V_{DD} = 50\text{ V}$ (see table 21)
Avalanche energy, repetitive	E_{AR}	-	-	0.32		$I_D = 1.8\text{ A}, V_{DD} = 50\text{ V}$
Avalanche current, repetitive	I_{AR}	-	-	1.8	A	
MOSFET dv/dt ruggedness	dv/dt	-	-	50	V/ns	$V_{DS} = 0 \dots 480\text{ V}$
Gate source voltage	V_{GS}	-20	-	20	V	static
		-30		30		AC ($f > 1\text{ Hz}$)
Power dissipation for Non FullPAK	P_{tot}	-	-	83	W	$T_C = 25\text{ °C}$
Power dissipation for FullPAK	P_{tot}	-	-	31	W	$T_C = 25\text{ °C}$
Operating and storage temperature	T_j, T_{stg}	-55	-	150	°C	
Mounting torque TO-220		-	-	60	Ncm	M3 and M3.5 screws
Mounting torque TO-220 FullPAK				50		M2.5 screws
Continuous diode forward current	I_S	-	-	9.2	A	$T_C = 25\text{ °C}$
Diode pulse current ²⁾	$I_{S,pulse}$	-	-	29	A	$T_C = 25\text{ °C}$
Reverse diode dv/dt ³⁾	dv/dt	-	-	15	V/ns	$V_{DS} = 0 \dots 480\text{ V}, I_{SD} \leq I_D,$ $T_j = 125\text{ °C}$ (see table 22)
Maximum diode commutation speed ³⁾	di/dt			500	A/ μ s	

1) Limited by $T_{j,max}$. Maximum duty cycle $D = 0.75$

2) Pulse width t_p limited by $T_{j,max}$

3) Identical low side and high side switch with identical R_G

3 Thermal characteristics

Table 3 Thermal characteristics TO-220

Parameter	Symbol	Values			Unit	Note / Test Condition
		Min.	Typ.	Max.		
Thermal resistance, junction - case	R_{thJC}	-	-	1.5	°C/W	leaded
Thermal resistance, junction - ambient	R_{thJA}	-	-	62		
Soldering temperature, wavesoldering only allowed at leads	T_{sold}	-	-	260	°C	1.6 mm (0.063 in.) from case for 10 s

Table 4 Thermal characteristics TO-220FullPAK

Parameter	Symbol	Values			Unit	Note / Test Condition
		Min.	Typ.	Max.		
Thermal resistance, junction - case	R_{thJC}	-	-	4.0	°C/W	leaded
Thermal resistance, junction - ambient	R_{thJA}	-	-	80		
Soldering temperature, wavesoldering only allowed at leads	T_{sold}	-	-	260	°C	1.6 mm (0.063 in.) from case for 10 s

Table 5 Thermal characteristics TO-252

Parameter	Symbol	Values			Unit	Note / Test Condition
		Min.	Typ.	Max.		
Thermal resistance, junction - case	R_{thJC}	-	-	1.5	°C/W	SMD version, device on PCB, minimal footprint
Thermal resistance, junction - ambient	R_{thJA}	-	-	62		
		-	35	-		
Soldering temperature, wave- & reflowsoldering allowed	T_{sold}	-	-	260	°C	reflow MSL1

1) Device on 40mm*40mm*1.5 epoxy PCB FR4 with 6cm² (one layer, 70µm thick) copper area for drain connection. PCB is vertical without air stream cooling.

4 Electrical characteristics

Electrical characteristics, at $T_J=25\text{ °C}$, unless otherwise specified

Table 6 Static characteristics

Parameter	Symbol	Values			Unit	Note / Test Condition
		Min.	Typ.	Max.		
Drain-source breakdown voltage	$V_{(BR)DSS}$	650	-	-	V	$V_{GS}=0\text{ V}$, $I_D=1.0\text{ mA}$
Gate threshold voltage	$V_{GS(th)}$	2.5	3	3.5		$V_{DS}=V_{GS}$, $I_D=0.32\text{ mA}$
Zero gate voltage drain current	I_{DSS}	-	-	1	μA	$V_{DS}=600\text{ V}$, $V_{GS}=0\text{ V}$, $T_J=25\text{ °C}$
		-	10	-		$V_{DS}=600\text{ V}$, $V_{GS}=0\text{ V}$, $T_J=150\text{ °C}$
Gate-source leakage current	I_{GSS}	-	-	100	nA	$V_{GS}=20\text{ V}$, $V_{DS}=0\text{ V}$
Drain-source on-state resistance	$R_{DS(on)}$	-	0.34	0.38	Ω	$V_{GS}=10\text{ V}$, $I_D=3.2\text{ A}$, $T_J=25\text{ °C}$
		-	0.89	-		$V_{GS}=10\text{ V}$, $I_D=3.2\text{ A}$, $T_J=150\text{ °C}$
Gate resistance	R_G	-	7.5	-	Ω	$f=1\text{ MHz}$, open drain

Table 7 Dynamic characteristics

Parameter	Symbol	Values			Unit	Note / Test Condition	
		Min.	Typ.	Max.			
Input capacitance	C_{iss}	-	710	-	pF	$V_{GS}=0\text{ V}$, $V_{DS}=100\text{ V}$, $f=1\text{ MHz}$	
Output capacitance	C_{oss}	-	41	-			
Effective output capacitance, energy related ¹⁾	$C_{o(er)}$	-	32	-			$V_{GS}=0\text{ V}$, $V_{DS}=0\dots480\text{ V}$
Effective output capacitance, time related ²⁾	$C_{o(tr)}$	-	140	-			$I_D=\text{constant}$, $V_{GS}=0\text{ V}$ $V_{DS}=0\dots480\text{ V}$
Turn-on delay time	$t_{d(on)}$	-	10	-	ns	$V_{DD}=400\text{ V}$, $V_{GS}=13\text{ V}$, $I_D=4.9\text{ A}$, $R_G=3.4\text{ }\Omega$ (see table 20)	
Rise time	t_r	-	7	-			
Turn-off delay time	$t_{d(off)}$	-	57	-			
Fall time	t_f	-	8	-			

1) $C_{o(er)}$ is a fixed capacitance that gives the same stored energy as C_{oss} while V_{DS} is rising from 0 to 80% $V_{(BR)DSS}$

2) $C_{o(tr)}$ is a fixed capacitance that gives the same charging time as C_{oss} while V_{DS} is rising from 0 to 80% $V_{(BR)DSS}$

Table 8 Gate charge characteristics

Parameter	Symbol	Values			Unit	Note / Test Condition
		Min.	Typ.	Max.		
Gate to source charge	Q_{gs}	-	4	-	nC	$V_{DD}=480\text{ V}$, $I_D=4.9\text{ A}$, $V_{GS}=0\text{ to }10\text{ V}$
Gate to drain charge	Q_{gd}	-	20	-		
Gate charge total	Q_g	-	39	-		
Gate plateau voltage	V_{plateau}	-	5.5	-	V	

Table 9 Reverse diode characteristics

Parameter	Symbol	Values			Unit	Note / Test Condition
		Min.	Typ.	Max.		
Diode forward voltage	V_{SD}	-	0.9	-	V	$V_{GS}=0\text{ V}$, $I_F=4.9\text{ A}$, $T_j=25\text{ °C}$
Reverse recovery time	t_{rr}	-	280	-	ns	$V_R=400\text{ V}$, $I_F=4.9\text{ A}$, $di_F/dt=100\text{ A}/\mu\text{s}$ (see table 22)
Reverse recovery charge	Q_{rr}	-	2.8	-	μC	
Peak reverse recovery current	I_{rrm}	-	17	-	A	

5 Electrical characteristics diagrams

Table 10

Power dissipation Non FullPAK	Power dissipation FullPAK
$P_{tot} = f(T_C)$	$P_{tot} = f(T_C)$

Table 11

Max. transient thermal impedance Non FullPAK	Max. transient thermal impedance FullPAK
$Z_{(thJC)} = f(t_p)$; parameter: $D = t_p / T$	$Z_{(thJC)} = f(t_p)$; parameter: $D = t_p / T$

Table 12

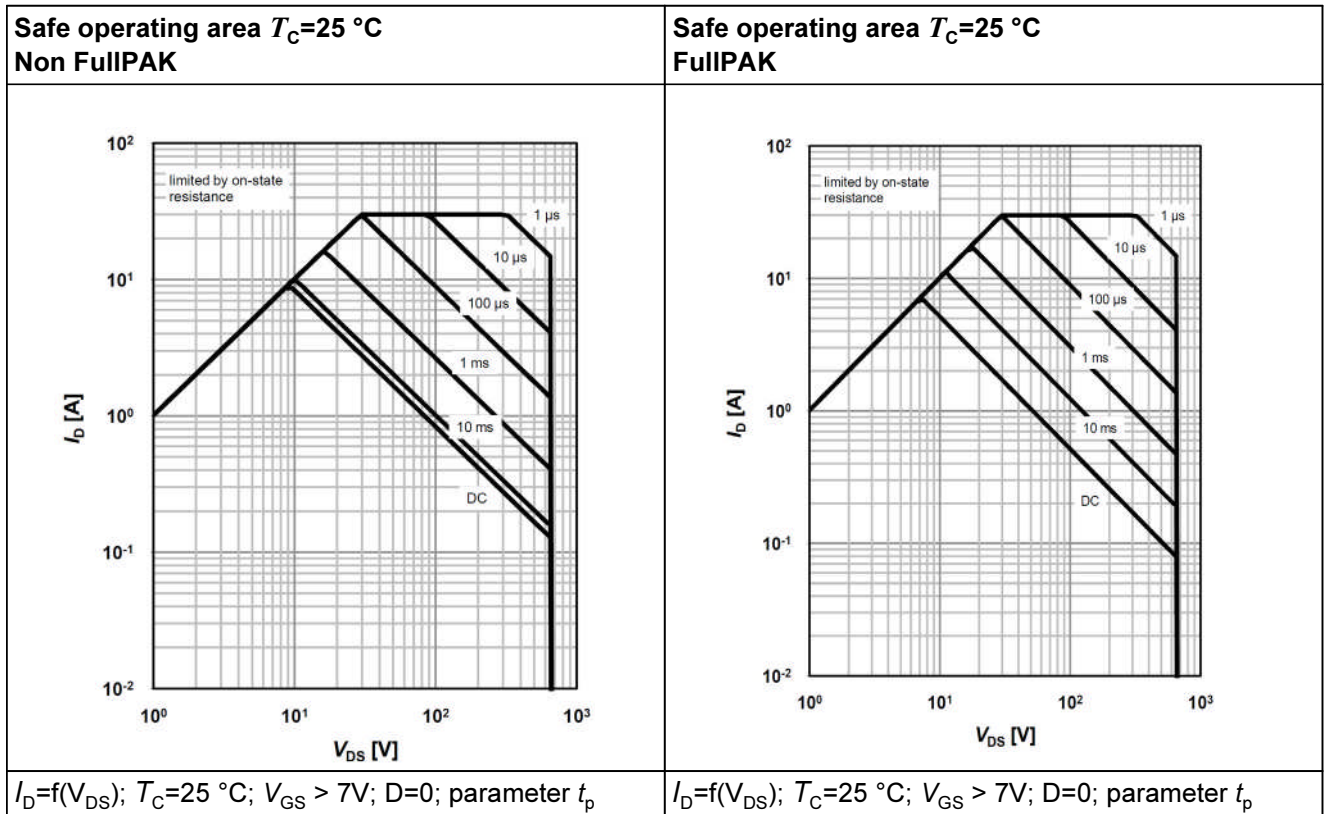

Table 13

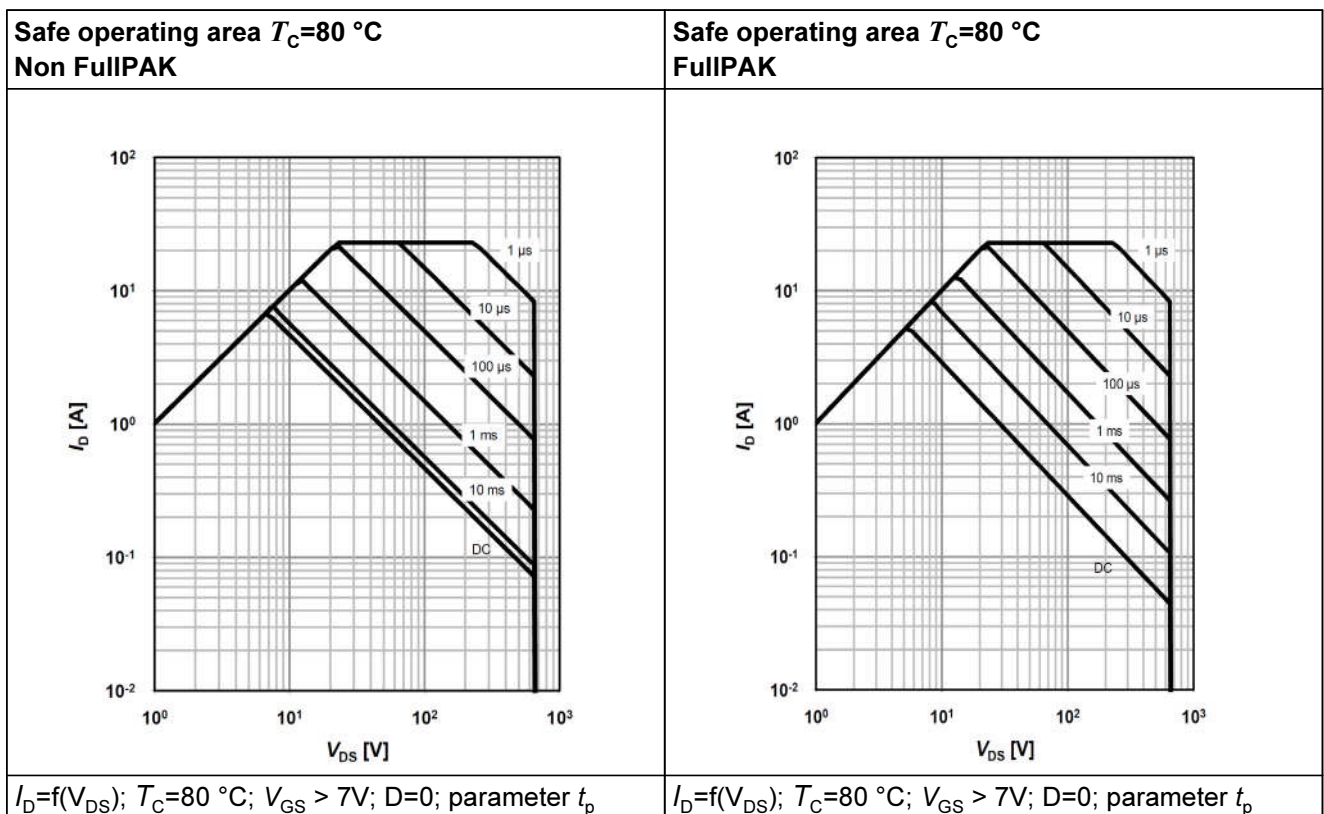

Table 14

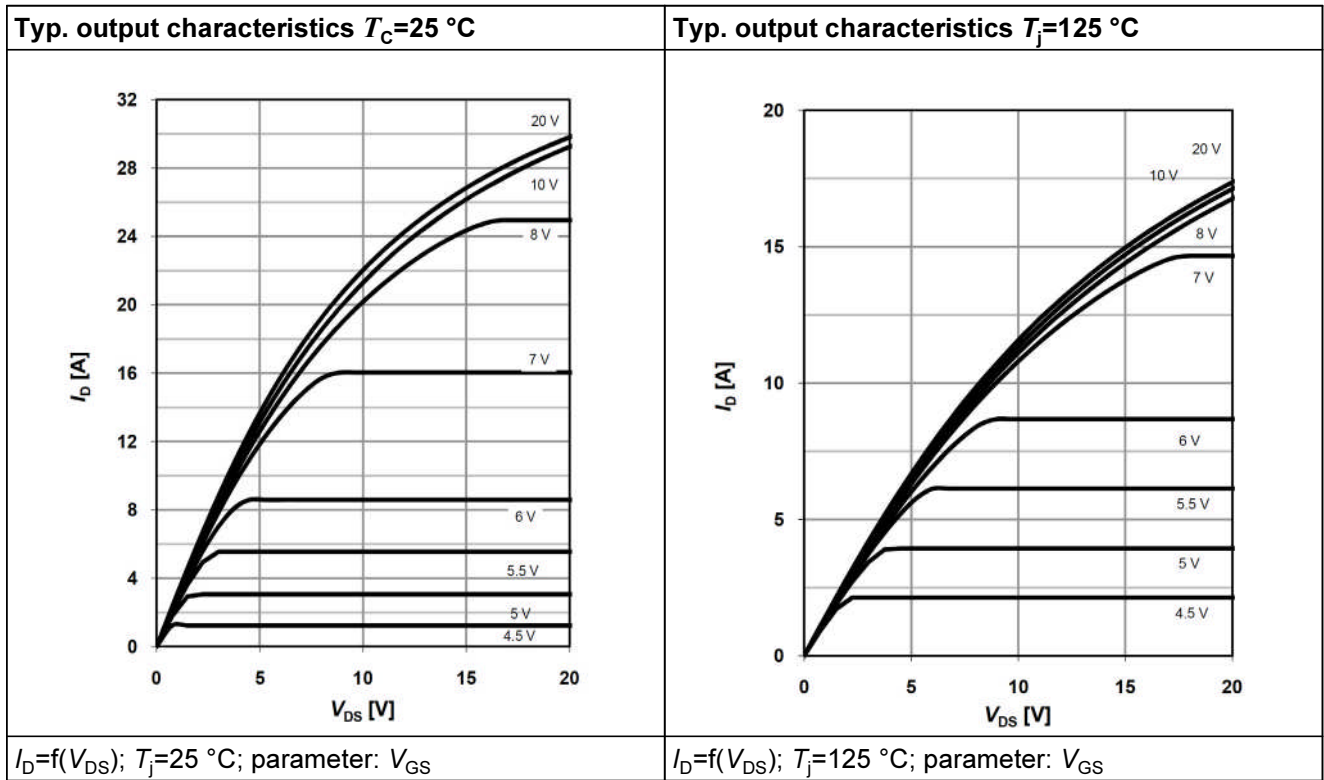

Table 15

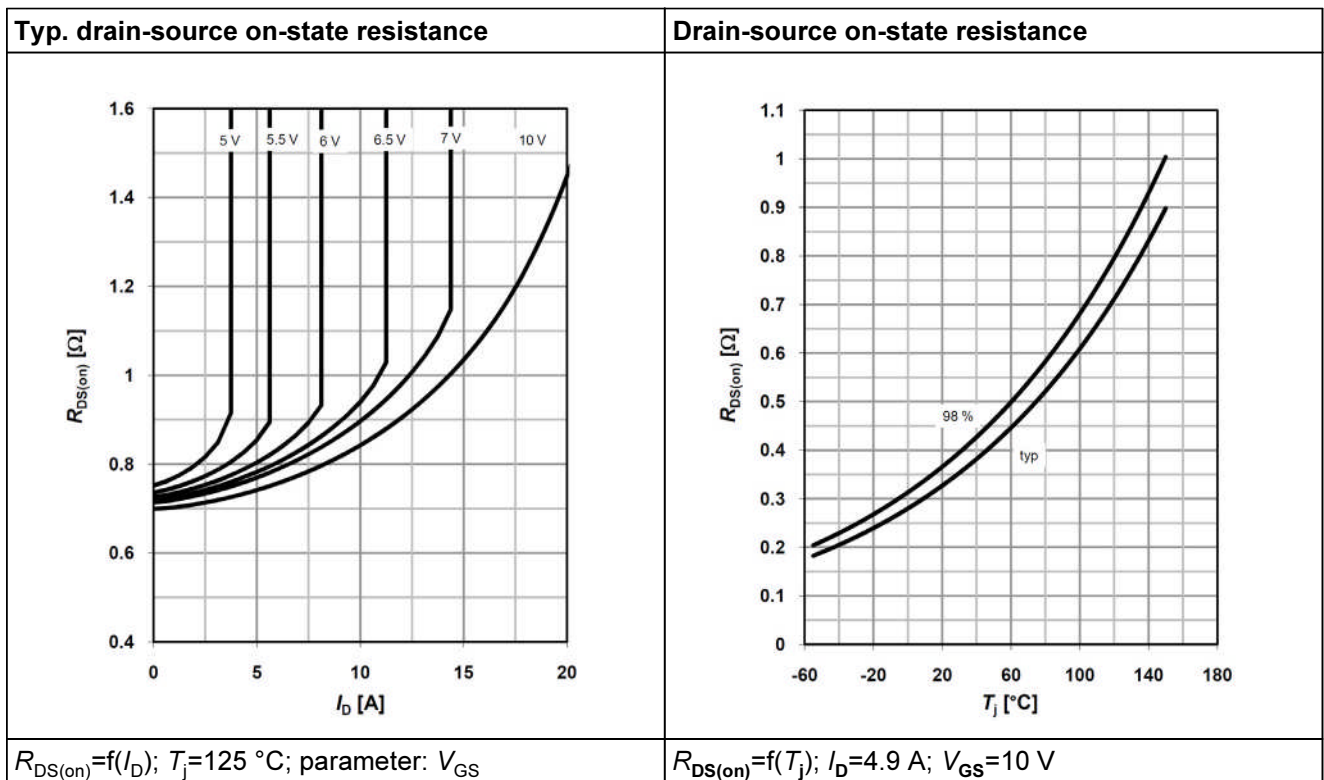

Table 16

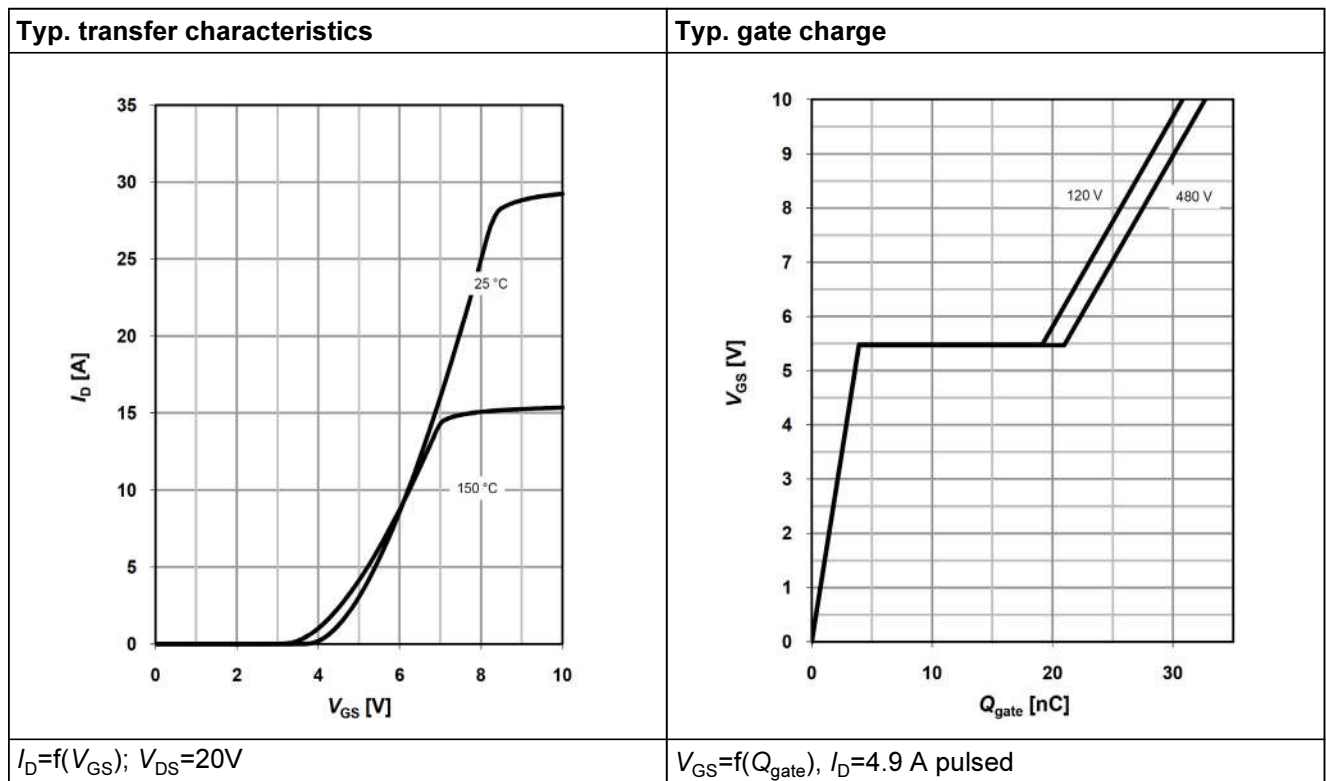

Table 17

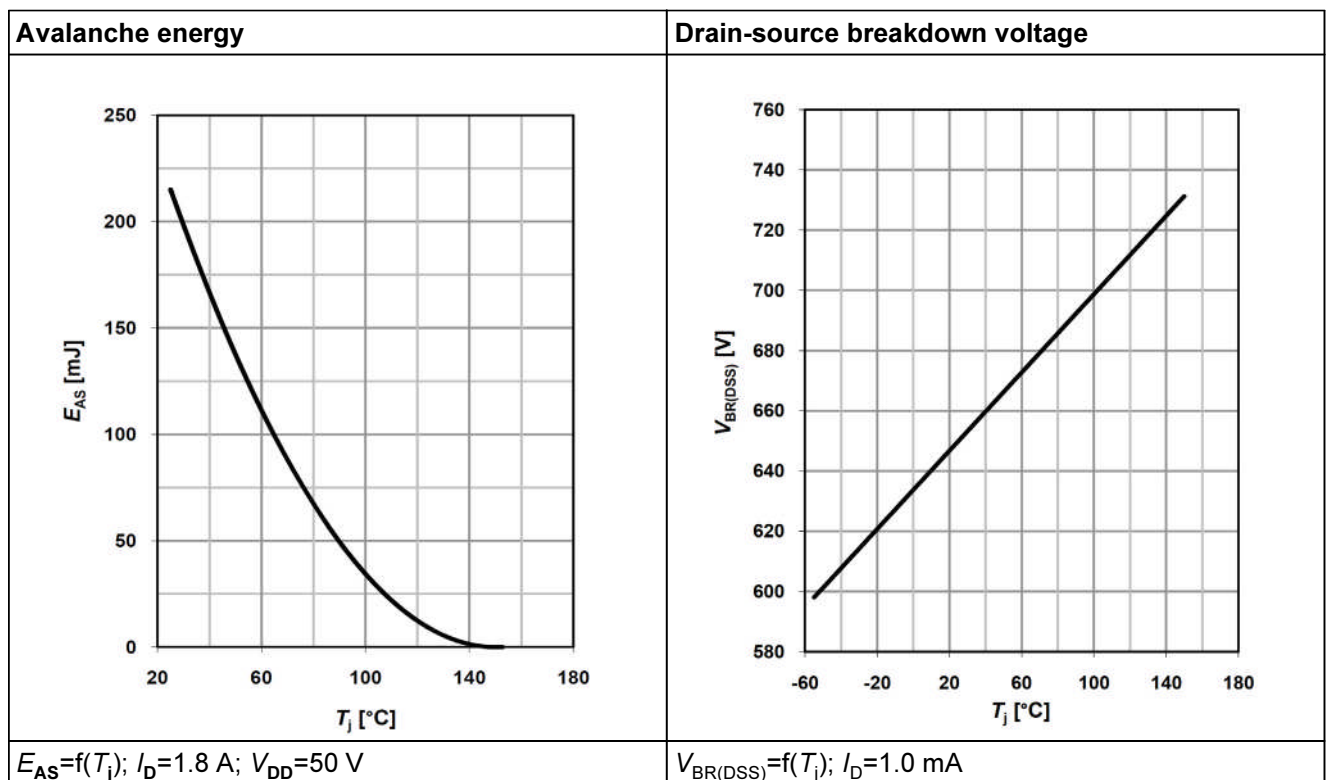

Table 18

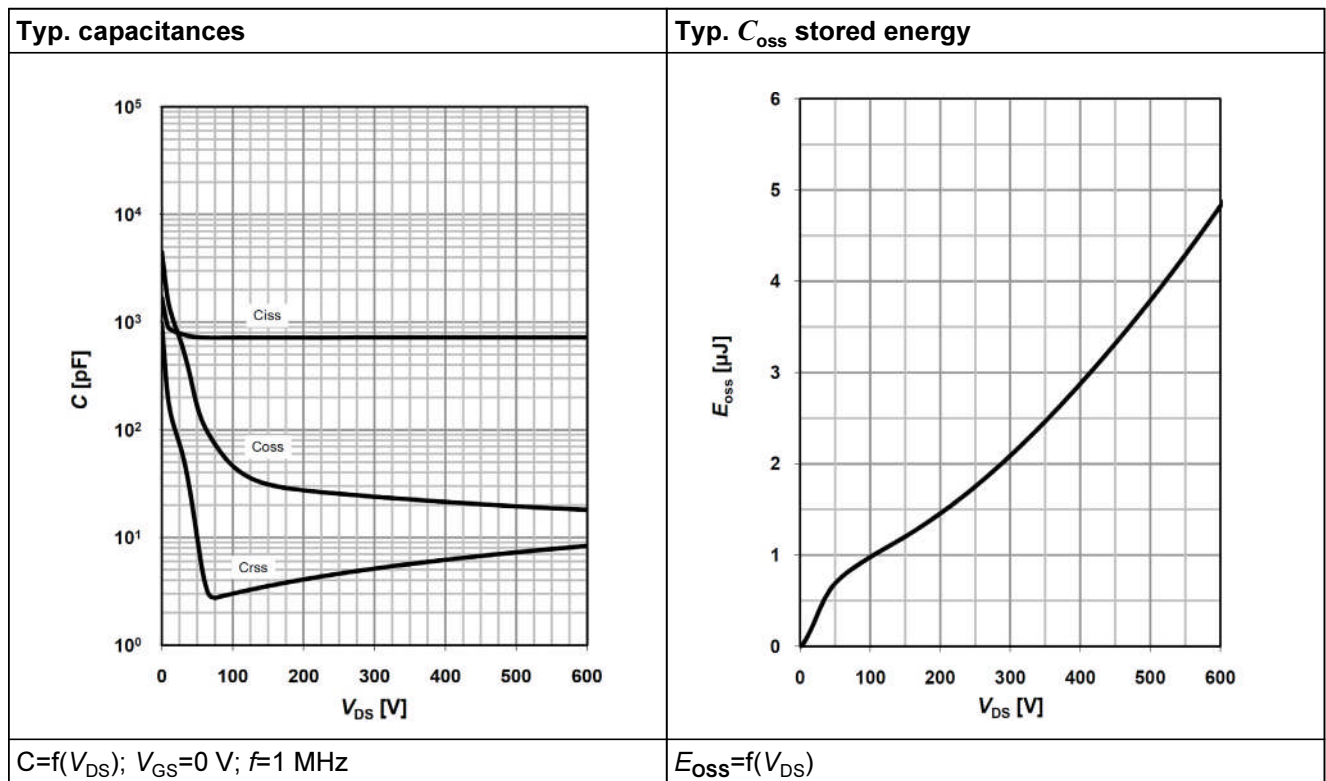
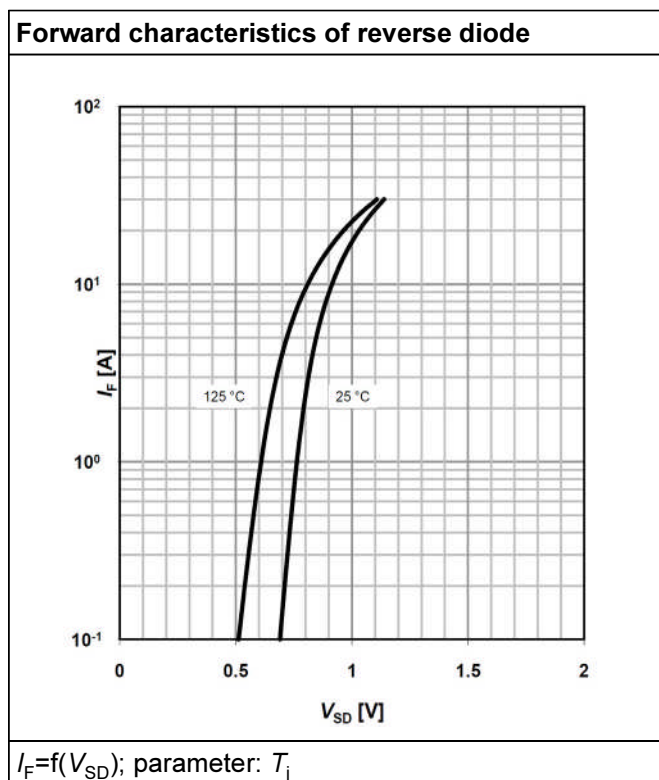

Table 19



6 Test circuits

Table 20 Switching times test circuit and waveform for inductive load

Switching times test circuit for inductive load	Switching time waveform

Table 21 Unclamped inductive load test circuit and waveform

Unclamped inductive load test circuit	Unclamped inductive waveform

Table 22 Test circuit and waveform for diode characteristics

Test circuit for diode characteristics	Diode recovery waveform

7 Package outlines

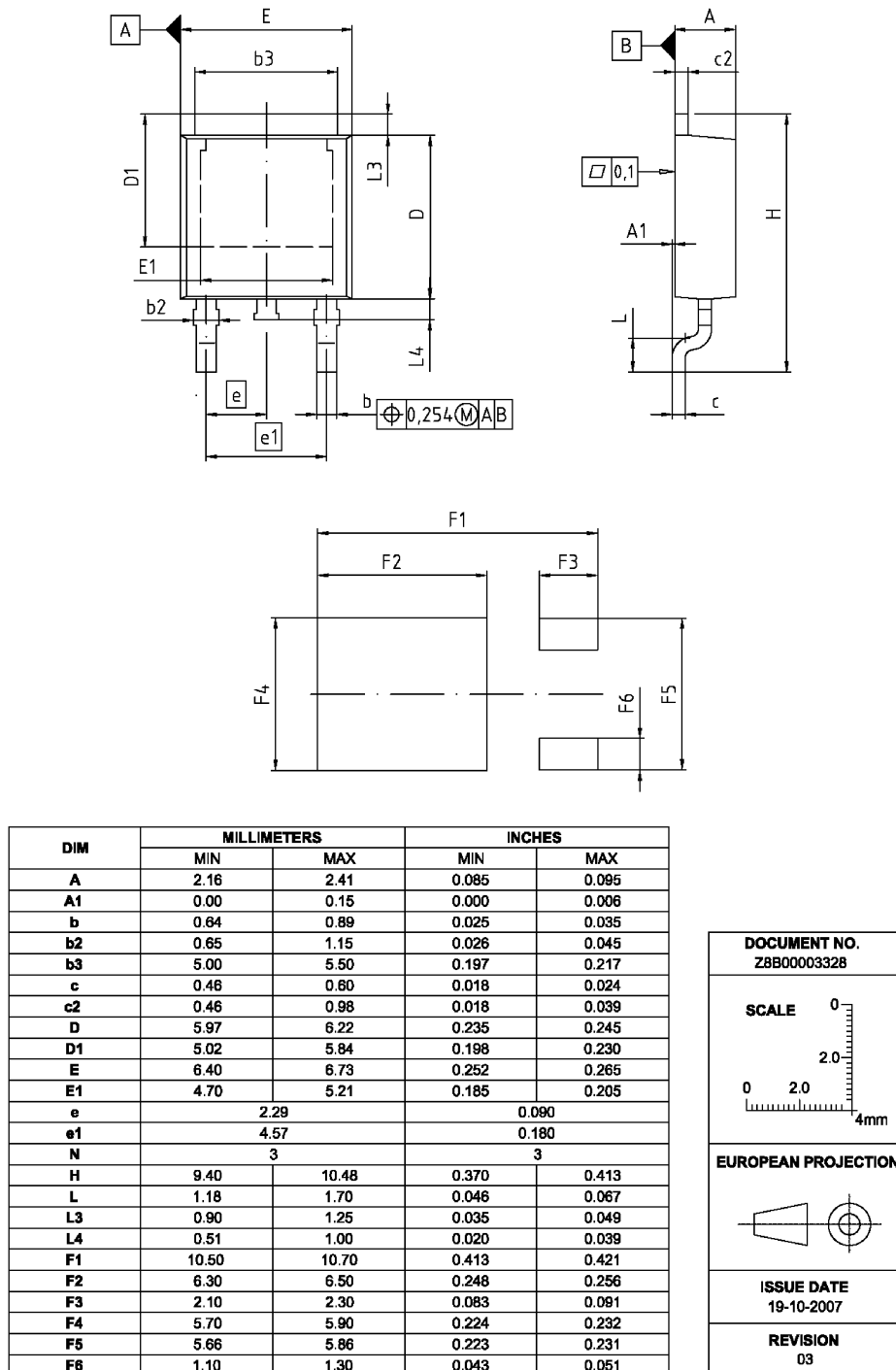
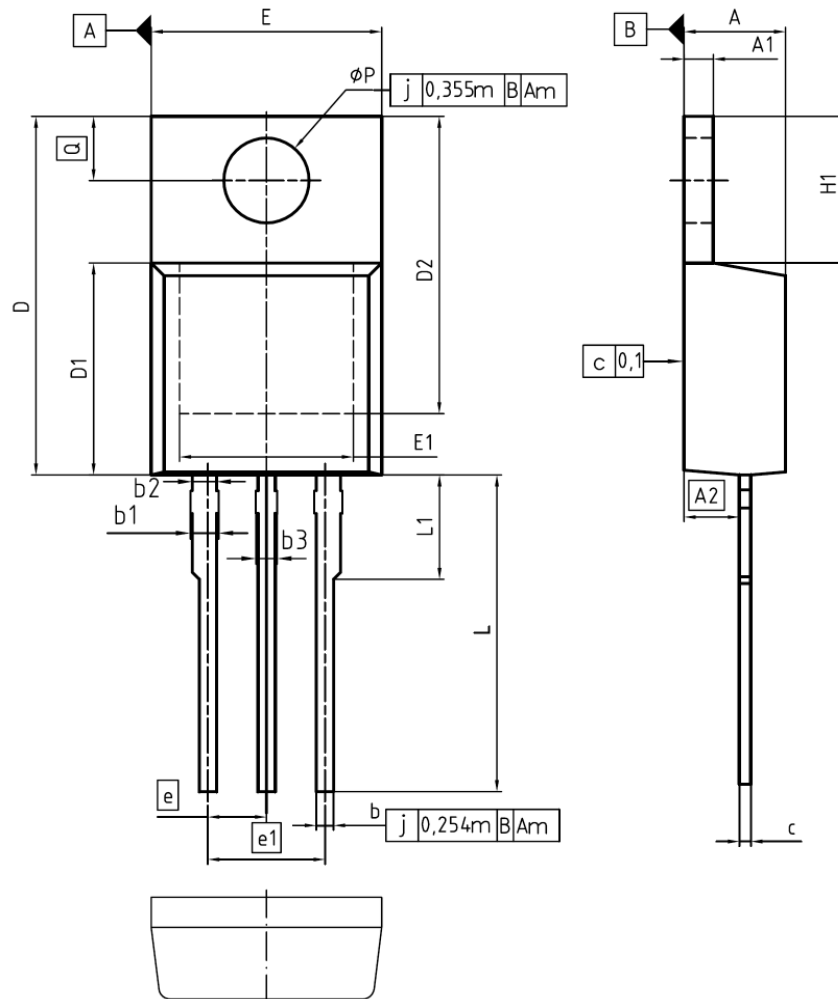

Figure 1 Outlines TO-252, dimensions in mm/inches



DIM	MILLIMETERS		INCHES	
	MIN	MAX	MIN	MAX
A	4.30	4.57	0.169	0.180
A1	1.17	1.40	0.046	0.055
A2	2.15	2.72	0.085	0.107
b	0.65	0.86	0.026	0.034
b1	0.95	1.40	0.037	0.055
b2	0.95	1.15	0.037	0.045
b3	0.65	1.15	0.026	0.045
c	0.33	0.60	0.013	0.024
D	14.81	15.95	0.583	0.628
D1	8.51	9.45	0.335	0.372
D2	12.19	13.10	0.480	0.516
E	9.70	10.36	0.382	0.408
E1	6.50	8.60	0.256	0.339
e	2.54		0.100	
e1	5.08		0.200	
N	3		3	
H1	5.90	6.90	0.232	0.272
L	13.00	14.00	0.512	0.551
L1	-	4.80	-	0.189
φP	3.60	3.89	0.142	0.153
Q	2.60	3.00	0.102	0.118

DOCUMENT NO.
Z8B00003318

SCALE

EUROPEAN PROJECTION

ISSUE DATE
23-08-2007

REVISION
05

Figure 2 Outlines TO-220, dimensions in mm/inches



DIM	MILLIMETERS		INCHES	
	MIN	MAX	MIN	MAX
A	4.55	4.85	0.179	0.191
A1	2.55	2.85	0.100	0.112
A2	2.42	2.72	0.095	0.107
b	0.65	0.85	0.026	0.033
b1	0.95	1.33	0.037	0.052
b2	0.95	1.51	0.037	0.059
b3	0.65	1.33	0.026	0.052
b4	0.65	1.51	0.026	0.059
c	0.40	0.63	0.016	0.025
D	15.85	16.15	0.624	0.636
D1	9.53	9.83	0.375	0.387
E	10.35	10.65	0.407	0.419
e	2.54		0.100	
e1	5.08		0.200	
N	3		3	
H	29.45	29.75	1.159	1.171
L	13.45	13.75	0.530	0.541
L1	3.15	3.45	0.124	0.136
øP	2.95	3.20	0.116	0.126
Q	3.15	3.50	0.124	0.138

DOCUMENT NO.
Z8B00003319

SCALE

EUROPEAN PROJECTION

ISSUE DATE
08-03-2007

REVISION
03

Figure 3 Outlines TO-220 FullIPAK, dimensions in mm/inches

8 Revision History

Revision History: 2013-07-31, Rev. 2.1

Previous Revision: 2.0

Revision	Subjects (major changes since last revision)
2.0	Release of final data sheet
2.1	Update halogen free mold compound status of PG-TO252 package

We Listen to Your Comments

Any information within this document that you feel is wrong, unclear or missing at all?

Your feedback will help us to continuously improve the quality of this document.

Please send your proposal (including a reference to this document) to: erratum@infineon.com



Edition 2010-01-02

Published by

Infineon Technologies AG

81726 Munich, Germany

© 2010 Infineon Technologies AG

All Rights Reserved.

Legal Disclaimer

The information given in this document shall in no event be regarded as a guarantee of conditions or characteristics. With respect to any examples or hints given herein, any typical values stated herein and/or any information regarding the application of the device, Infineon Technologies hereby disclaims any and all warranties and liabilities of any kind, including without limitation, warranties of non-infringement of intellectual property rights of any third party.

Information

For further information on technology, delivery terms and conditions and prices, please contact the nearest Infineon Technologies Office (www.infineon.com).

Warnings

Due to technical requirements, components may contain dangerous substances. For information on the types in question, please contact the nearest Infineon Technologies Office.

Infineon Technologies components described in this Data Sheet may be used in life-support devices or systems and/or automotive, aviation and aerospace applications or systems only with the express written approval of Infineon Technologies, if a failure of such components can reasonably be expected to cause the failure of that life-support, automotive, aviation and aerospace device or system or to affect the safety or effectiveness of that device or system. Life support devices or systems are intended to be implanted in the human body or to support and/or maintain and sustain and/or protect human life. If they fail, it is reasonable to assume that the health of the user or other persons may be endangered.