



# CFS50-AGV02X04

CFS50

MOTOR FEEDBACK SYSTEMS ROTARY INCREMENTAL WITH COMMUTATION

**SICK**  
Sensor Intelligence.



Illustration may differ

### Ordering information

Type	Part no.
CFS50-AGV02X04	1055093

Other models and accessories → [www.sick.com/CFS50](http://www.sick.com/CFS50)

### Detailed technical data

#### Performance

<b>Number of lines per revolution</b>	2,000 <sup>1)</sup>
<b>Measuring step</b>	90° / number of lines
<b>Commutation signals</b>	4 pole pairs (See diagram, different commutation on request)
<b>Reference signal, number</b>	1
<b>Reference signal, position</b>	90° electric, logically gated with A and B
<b>Operating speed</b>	6,000 min <sup>-1</sup>

<sup>1)</sup> Number of lines from 1 ... 1,000 and > 4,096 ... 65,536 on request.

#### Interfaces

<b>Communication interface</b>	TTL/RS422
--------------------------------	-----------

#### Electrical data

<b>Supply voltage range</b>	4.5 V DC ... 5.5 V DC
<b>Operating power consumption (no load)</b>	≤ 60 mA <sup>1)</sup>
<b>Maximum output frequency</b>	≤ 820 kHz

<sup>1)</sup> Without load.

#### Mechanical data

<b>Shaft version</b>	Tapered shaft
<b>Flange type / stator coupling</b>	Resolver support
<b>Dimensions</b>	See dimensional drawing
<b>Weight</b>	0.1 kg
<b>Moment of inertia of the rotor</b>	10 gcm <sup>2</sup>
<b>Operating speed</b>	12,000 min <sup>-1</sup>
<b>Angular acceleration</b>	≤ 200,000 rad/s <sup>2</sup>
<b>Operating torque</b>	0.2 Ncm
<b>Start up torque</b>	0.4 Ncm
<b>Permissible shaft movement, radial static/dynamic</b>	± 0.5 mm / ± 0.1 mm
<b>Permissible shaft movement, axial static/dynamic</b>	± 0.75 mm / ± 0.2 mm
<b>Angular motion perpendicular to the rotational axis, static</b>	± 0.005 mm/mm

<b>Angular motion perpendicular to the rotational axis, dynamic</b>	± 0.0025 mm/mm
<b>Life of ball bearings</b>	3.6 x 10 <sup>9</sup> revolutions
<b>Connection type</b>	Stranded cable, 15-pin, radial

## Ambient data

<b>Operating temperature range</b>	-20 °C ... +115 °C
<b>Storage temperature range</b>	-40 °C ... +125 °C, without package
<b>Relative humidity/condensation</b>	90 %, Condensation not permitted
<b>Resistance to shocks</b>	100 g, 10 ms (according to EN 60068-2-27)
<b>Frequency range of resistance to vibrations</b>	20 g, 10 Hz ... 2,000 Hz (according to EN 60068-2-6)
<b>EMC</b>	According to EN 61000-6-2 and EN 61000-6-3 <sup>1)</sup>
<b>Enclosure rating</b>	IP40 (according to IEC 60529)

<sup>1)</sup> The EMC according to the standards quoted is achieved when the motor feedback system is mounted in an electrically conductive housing, which is connected to the central earthing point of the motor controller via a cable screen. The GND-(0 V) connection of the supply voltage is also grounded here. If other shielding concepts are used, users must perform their own tests.

## Classifications

<b>ECl@ss 5.0</b>	27270501
<b>ECl@ss 5.1.4</b>	27270501
<b>ECl@ss 6.0</b>	27270590
<b>ECl@ss 6.2</b>	27270590
<b>ECl@ss 7.0</b>	27270501
<b>ECl@ss 8.0</b>	27270501
<b>ECl@ss 8.1</b>	27270501
<b>ECl@ss 9.0</b>	27270501
<b>ETIM 5.0</b>	EC001486
<b>ETIM 6.0</b>	EC001486
<b>UNSPSC 16.0901</b>	41112113

### Dimensional drawing (Dimensions in mm (inch))

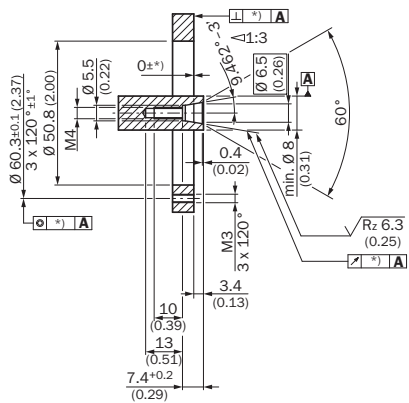
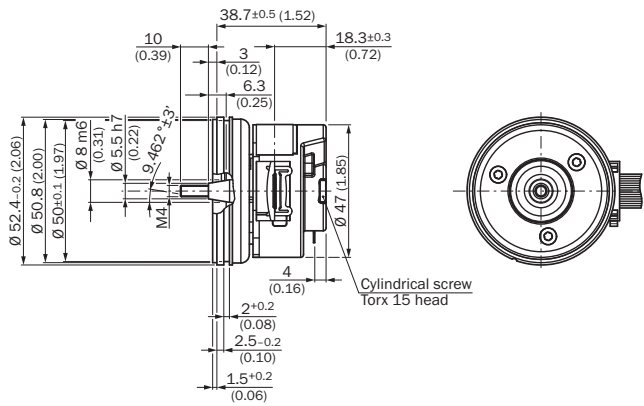

\*) Size of tolerance reduce the allowed movement of the shaft, see data sheet.

### Proposed fitting

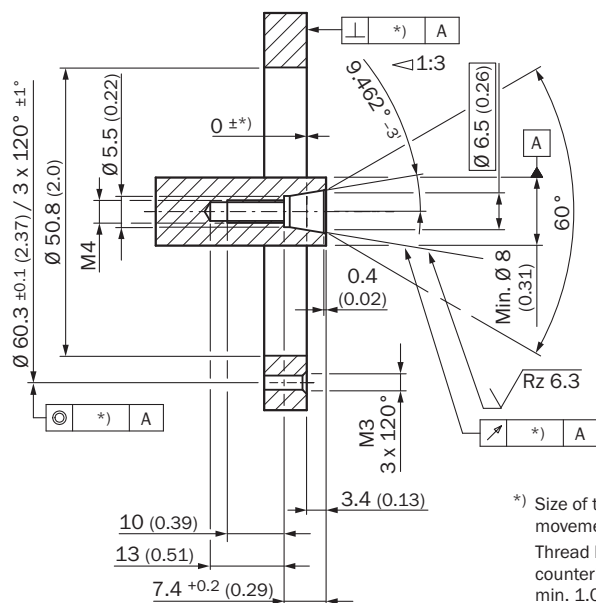

\*) Size of tolerance reduce the allowed movement of the shaft, see data sheet.  
 Thread holes according DIN 13 with counterbore according DIN 76 min. 1.05 x diameter of thread.

## PIN assignment

PIN	Color	Signal
1	Blue	Ground connection (GND)
2	Red	Supply voltage 5 V ± 10 % (U <sub>L</sub> )
3	Yellow	Reference signal inverted (Z̄)
4	Purple	Reference signal (Z)
5	Brown	Increment signal inverted (Ā)
6	White	Increment signal (A)
7	Black	Increment signal inverted (B̄)
8	Pink	Increment signal (B)
9	White/Red	Commutation signal inverted (T̄)
10	White/Gray	Commutation signal (T)
11	White/Blue	Commutation signal inverted (S̄)
12	White/Yellow	Commutation signal (S)
13	White/Pink	Commutation signal inverted (R̄)
14	White/Green	Commutation signal (R)
15	Gray	Electronic setting of the commutation signals (SET0)

## Diagram

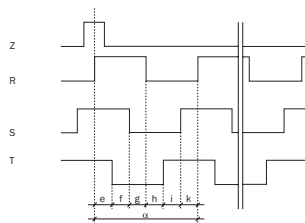

Polpairs	Number of poles	e, f, g, h, i, k	α
2	4	30°	180°
3	6	20°	120°
4	8	15°	90°
6	12	10°	60°
8	16	7.5°	45°

The angle information is related to a mechanical shaft rotation. Flank precision of the signals R, S, T ± 1°.

At constant speed, looking at the input shaft, and clockwise rotation

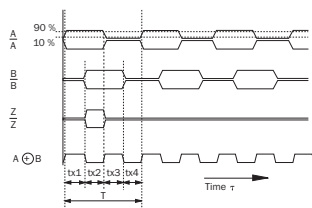

At constant rotational speed with regard to the input shaft and rotation in clockwise direction.

By connecting the two signals A and B, an output signal arises whose period durations tx1 ... tx4 have varying lengths.

The differences are determined:

- by the pulse/pause ratio tolerance of the individual channels
- by the tolerance in the 90° phase shift between A and B
- by the frequency

The times tx1 ... tx4 ideally have to amount to 1/4 of the particular period duration T. The typical output frequency of the encoder is defined so that the max. time tx is smaller than 1.5 x 1/4.

## Recommended accessories

Other models and accessories → [www.sick.com/CFS50](http://www.sick.com/CFS50)

	Brief description	Type	Part no.
Plug connectors and cables			
	Head A: female connector, JST, 8-pin, straight Head B: male connector, M23, 17-pin, straight Cable: Incremental, unshielded, 1 m	DSL-2317-G01MJB7	2071332

	Brief description	Type	Part no.
	Head A: female connector, terminal box, 8-pin, straight Head B: male connector, M23, 17-pin, straight Cable: Incremental, unshielded, 1 m	DSL-2317-G01MJC7	2071331

## SICK AT A GLANCE

SICK is one of the leading manufacturers of intelligent sensors and sensor solutions for industrial applications. A unique range of products and services creates the perfect basis for controlling processes securely and efficiently, protecting individuals from accidents and preventing damage to the environment.

We have extensive experience in a wide range of industries and understand their processes and requirements. With intelligent sensors, we can deliver exactly what our customers need. In application centers in Europe, Asia and North America, system solutions are tested and optimized in accordance with customer specifications. All this makes us a reliable supplier and development partner.

Comprehensive services complete our offering: SICK LifeTime Services provide support throughout the machine life cycle and ensure safety and productivity.

For us, that is “Sensor Intelligence.”

## WORLDWIDE PRESENCE:

Contacts and other locations –[www.sick.com](http://www.sick.com)