

EVALUATION KIT
AVAILABLE

MAXIM

Low-Cost, 3-Channel, HD/PS/SD/BP Video Filters with Buffer

General Description

The MAX11508/MAX11509 integrated 3-channel video filters for high-definition (HD), progressive-scan (PS), standard-definition (SD), and bypass (BP) video include an output buffer with +6dB gain and are ideal for digital video disc (DVD) players, set-top box (STB) receivers, high-definition television (HDTV), digital video recorders (DVRs), and similar devices.

The MAX11508/MAX11509 video inputs feature a transparent clamp compatible with AC- and DC-coupled input signals and allow DAC outputs to be directly coupled, eliminating the need for bulky coupling capacitors. The filter bandwidths are selectable to HD, PS, and SD. A BP mode is provided for 1080p and high-bandwidth RGB signals. Selectable input bias circuitry on 2 filter channels offers simple connection to bipolar video signals such as C, Pb, and Pr.

The MAX11508 filters provide -3dB bandwidths of 9MHz (SD), 16MHz (PS), 33MHz (HD), and 60MHz (BP). The MAX11509 filters provide -3dB bandwidths of 10MHz (SD), 17MHz (PS), 34MHz (HD), and 60MHz (BP).

Each channel includes an output buffer with +6dB gain that provides a full 2V_{P-P} video signal into a 150Ω video load. The buffers drive either AC- or DC-coupled loads and assure a blanking level of below 1V after the back-match resistor. The shutdown mode provided reduces device current to 1μA (typ).

The MAX11508 offers a flat passband and the MAX11509 features +0.8dB peaking to compensate for DAC rolloff. The MAX11508/MAX11509 operate from a 5V power supply and operate over the upper commercial (0°C to +85°C) temperature range. The parts are offered in the 14-pin TSSOP package.

Applications

- Cable and Satellite STB Receivers
- HDTV
- DVD Players
- Personal Video Recorders
- DVRs
- Video-On-Demand
- HD Recorders

Typical Operating Circuit appears at end of data sheet.

Features

- ◆ Three Selectable 6th-Order 9MHz/16MHz/33MHz (SD/PS/HD) Filters
- ◆ Bypass Mode for High Bandwidth Signals
- ◆ Transparent Input Clamp
- ◆ Output Buffers Drive a Standard 150Ω Video Load
- ◆ ±12kV HBM ESD Protection on Outputs
- ◆ AC- or DC-Coupled Inputs
- ◆ AC- or DC-Coupled Outputs
- ◆ +0.8dB Peaking Passband Response (MAX11509) in SD, PS, and HD Modes
- ◆ Single +5V Power Supply
- ◆ Lead-Free, 14-Pin TSSOP Package

Ordering Information

PART	TEMP RANGE	PIN-PACKAGE
MAX11508UUD+	0°C to +85°C	14 TSSOP
MAX11509UUD+	0°C to +85°C	14 TSSOP

+Denotes a lead-free/RoHS-compliant package.

Pin Configuration

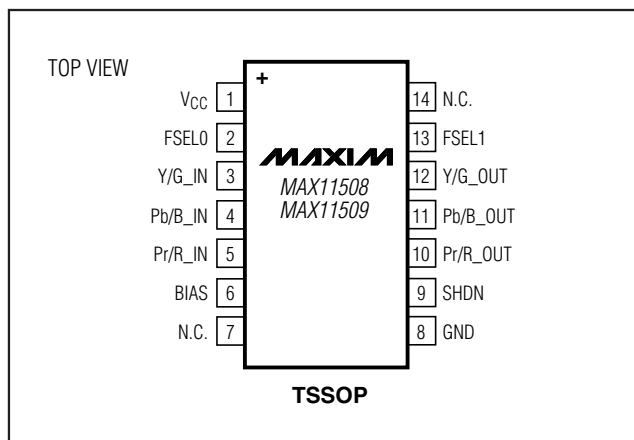

MAXIM

Maxim Integrated Products 1

For pricing, delivery, and ordering information, please contact Maxim Direct at 1-888-629-4642, or visit Maxim's website at www.maxim-ic.com.

Low-Cost, 3-Channel, HD/PS/SD/BP Video Filters with Buffer

ABSOLUTE MAXIMUM RATINGS

V_{CC} to GND-0.3V to +6V
 All Other Pins to GND-0.3V to the lower of
 (V_{CC} + 0.3V) and +6V
 Continuous Power Dissipation (T_A = +70°C)
 14-Pin TSSOP (derate 10mW/°C above +70°C)796.8mW
 Maximum Current into Any Pin Except V_{CC} and GND±50mA

Operating Temperature Range0°C to +85°C
 Storage Temperature Range-65°C to +150°C
 Lead Temperature (soldering, 10s)+300°C
 Junction Temperature+150°C

Stresses beyond those listed under "Absolute Maximum Ratings" may cause permanent damage to the device. These are stress ratings only, and functional operation of the device at these or any other conditions beyond those indicated in the operational sections of the specifications is not implied. Exposure to absolute maximum rating conditions for extended periods may affect device reliability.

ELECTRICAL CHARACTERISTICS

(V_{CC} = +5V, R_{LOAD} = 150Ω to GND, C_{IN} = 0.1μF, T_A = 0°C to +85°C, all frequency responses are relative to 100kHz, unless otherwise noted.) (Note 1)

PARAMETER	SYMBOL	CONDITIONS	MIN	TYP	MAX	UNITS
DC CHARACTERISTICS						
Supply Current	I _{CC}	No load		24	35	mA
Supply Voltage Range	V _{DD}		4.75	5.00	5.25	V
Input Voltage Range	V _{IN}	Referenced to GND if DC-coupled		1.4		V
Power-Down Current	I _{PD}	BIAS = high		1		μA
		BIAS = low		15		
Digital Input High Voltage	V _{IH}		2.0			V
Digital Input Low Voltage	V _{IL}				0.8	V
STANDARD-DEFINITION VIDEO						
-1dB Bandwidth	f _{1dB}	MAX11508, T _A = +25°C	4.5	7.9		MHz
		MAX11509, T _A = +25°C	5	8.6		
-3dB Bandwidth	f _{3dB}	MAX11508		9.0		MHz
		MAX11509		10		
Stopband Attenuation	A _{SB}	f = 27MHz	35	48		dB
Low-Frequency Gain	A _V	No load	5.6	6.0	6.6	dB
Differential Gain	dG	All channels		0.7		%
Differential Phase	dφ	All channels		0.7		Degrees
Total Harmonic Distortion	THD	V _{OUT} = 1.4V _{P-P} , f = 1MHz, all channels		-60		dB
Signal-to-Noise Ratio	SNR	2V _{P-P} signal to RMS noise, f = 100kHz to 4.2MHz		71		dB
Group Delay	t _G	f = 4.5MHz		59		ns
Power-Supply Rejection Ratio	PSRR	DC, all channels		50		dB

Low-Cost, 3-Channel, HD/PS/SD/BP Video Filters with Buffer

MAX11508/MAX11509

ELECTRICAL CHARACTERISTICS (continued)

($V_{CC} = +5V$, $R_{LOAD} = 150\Omega$ to GND, $C_{IN} = 0.1\mu F$, $T_A = 0^\circ C$ to $+85^\circ C$, all frequency responses are relative to 100kHz, unless otherwise noted.) (Note 1)

PARAMETER	SYMBOL	CONDITIONS	MIN	TYP	MAX	UNITS
PROGRESSIVE-SCAN VIDEO						
-1dB Bandwidth	f_{1dB}	MAX11508, $T_A = +25^\circ C$	9	13.5		MHz
		MAX11509, $T_A = +25^\circ C$	10	14		
-3dB Bandwidth	f_{3dB}	MAX11508		16		MHz
		MAX11509		17		
Stopband Attenuation	A_{SB}	$f = 54MHz$		44		dB
Low-Frequency Gain	A_V		5.6	6.0	6.6	dB
Total Harmonic Distortion	THD	$V_{OUT} = 1.4V_{P-P}$, $f = 7MHz$		-55		dB
Signal-to-Noise Ratio	SNR	2V _{P-P} signal to RMS noise, $f = 100kHz$ to 15MHz		66		dB
Group Delay	t_G	$f = 10MHz$		47		ns
HIGH-DEFINITION VIDEO						
-1dB Bandwidth	f_{1dB}	MAX11508, $T_A = +25^\circ C$	21	30		MHz
		MAX11509, $T_A = +25^\circ C$	22	31		
-3dB Bandwidth	f_{3dB}	MAX11508		33		MHz
		MAX11509		34		
Stopband Attenuation	A_{SB}	$f = 37.125MHz$		6.5		dB
		$f = 44.25MHz$		14.5		
		$f = 74.25MHz$		45		
Low-Frequency Gain	A_V		5.4	6.0	6.6	dB
Total Harmonic Distortion	THD	$V_{OUT} = 1.4V_{P-P}$, $f = 10MHz$		-55		dB
		$V_{OUT} = 1.4V_{P-P}$, $f = 15MHz$		-50		
		$V_{OUT} = 1.4V_{P-P}$, $f = 22MHz$		-40		
Signal-to-Noise Ratio	SNR	2V _{P-P} signal to RMS noise, $f = 100kHz$ to 30MHz		65		dB
Group Delay	t_G	$f = 20MHz$		25		ns
BYPASS VIDEO (Note 2)						
-3dB Bandwidth	f_{3dB}			60		MHz
Low-Frequency Gain	A_V		5.4	6.0	6.6	dB
Total Harmonic Distortion	THD	$V_{OUT} = 1.4V_{P-P}$, $f = 22MHz$		-40		dB
Signal-to-Noise Ratio	SNR	2V _{P-P} signal to RMS noise, $f = 100kHz$ to 30MHz		65		dB

Note 1: All devices are 100% production tested at $T_A = +25^\circ C$.

Note 2: Output AC-coupled with 220 μF into 150 Ω to GND.

Low-Cost, 3-Channel, HD/PS/SD/BP Video Filters with Buffer

Typical Operating Characteristics

($V_{CC} = 5V$, $R_L = 150\Omega$ to GND, output DC-coupled, $T_A = +25^\circ C$, unless otherwise noted.)

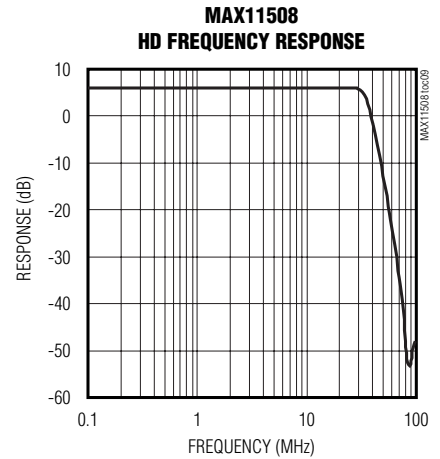
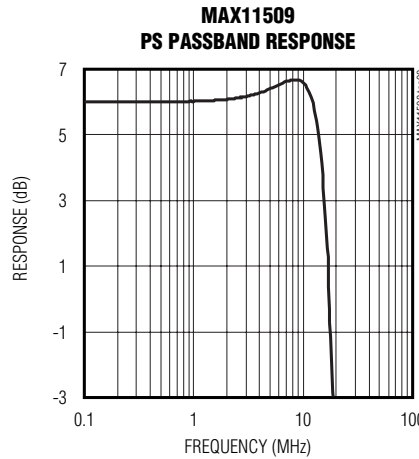
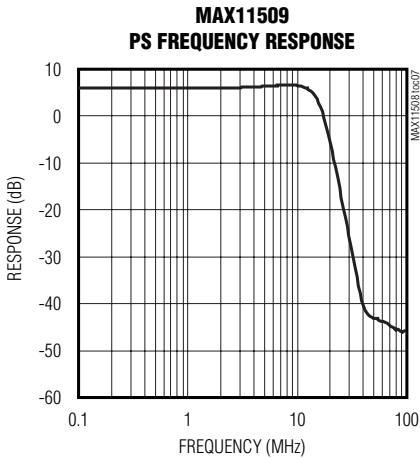
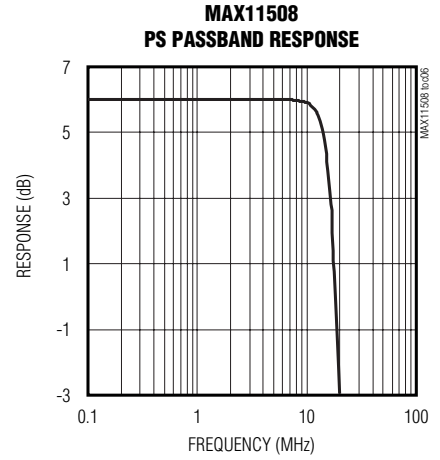
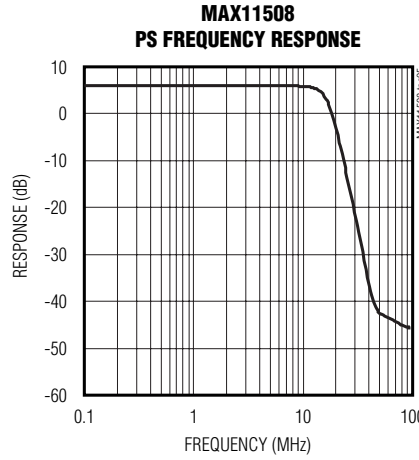
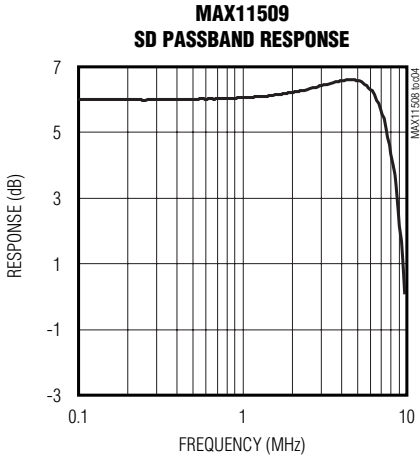
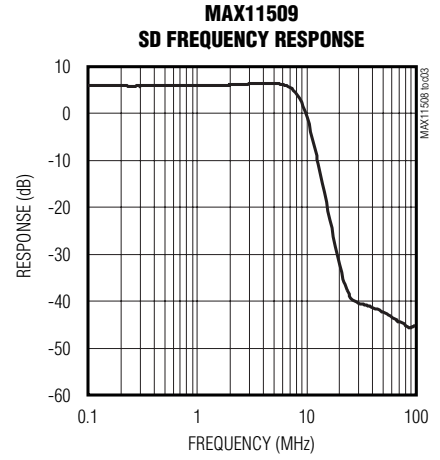
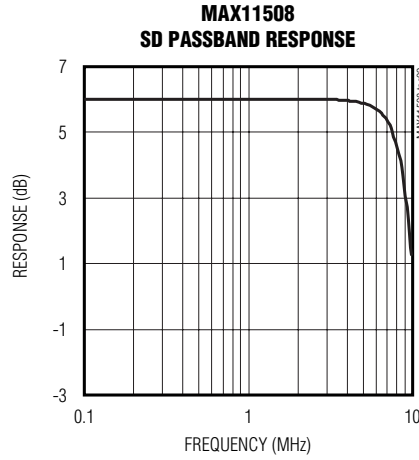
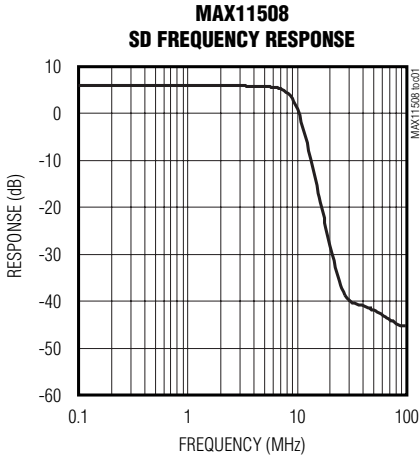

Low-Cost, 3-Channel, HD/PS/SD/BP Video Filters with Buffer

Typical Operating Characteristics (continued)

($V_{CC} = 5V$, $R_L = 150\Omega$ to GND, output DC-coupled, $T_A = +25^\circ C$, unless otherwise noted.)

MAX11508/MAX11509

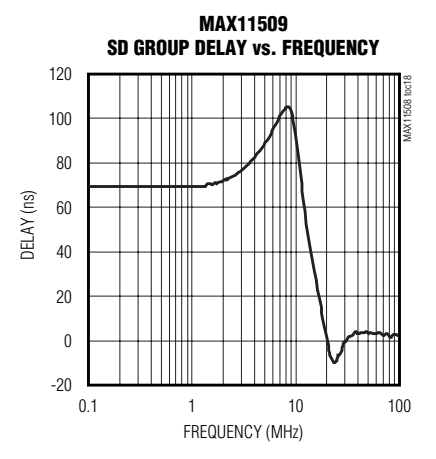
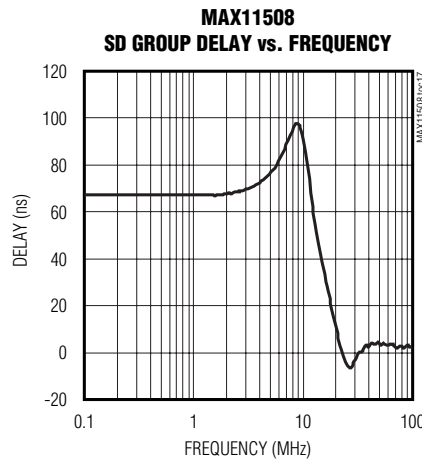
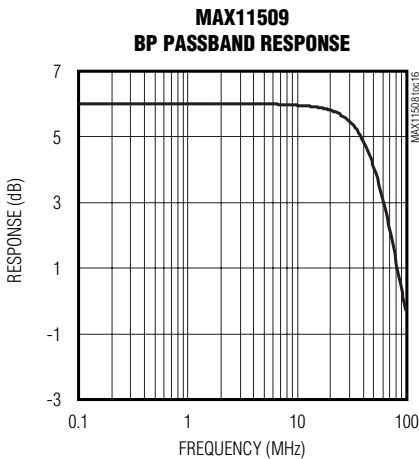
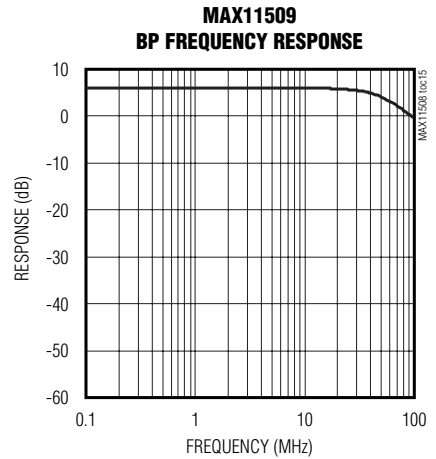
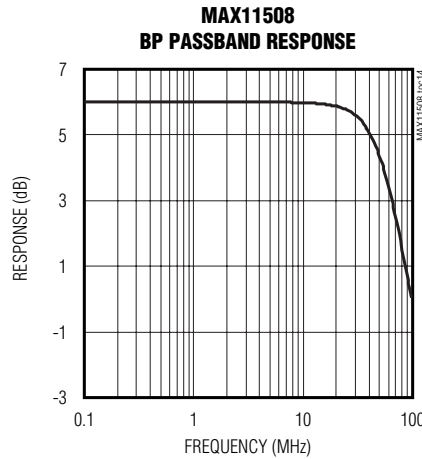
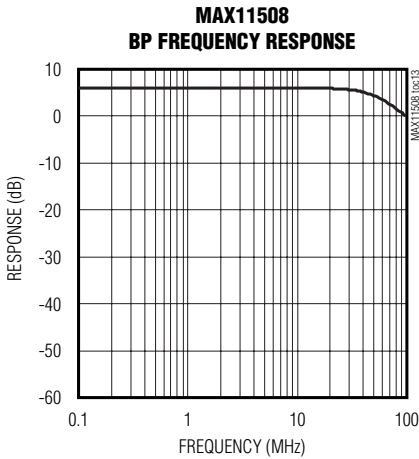
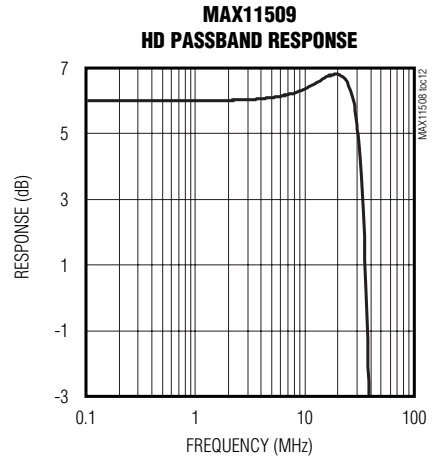
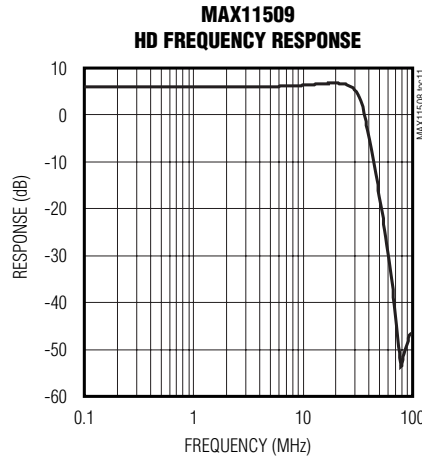
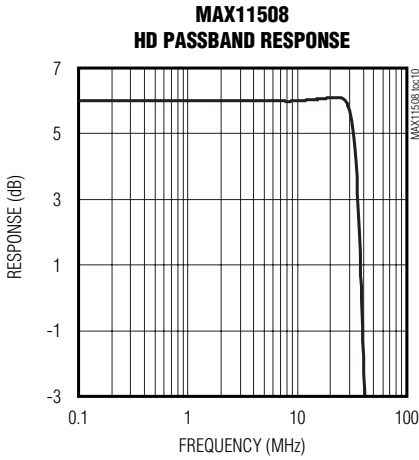

Low-Cost, 3-Channel, HD/PS/SD/BP Video Filters with Buffer

Typical Operating Characteristics (continued)

($V_{CC} = 5V$, $R_L = 150\Omega$ to GND, output DC-coupled, $T_A = +25^\circ C$, unless otherwise noted.)

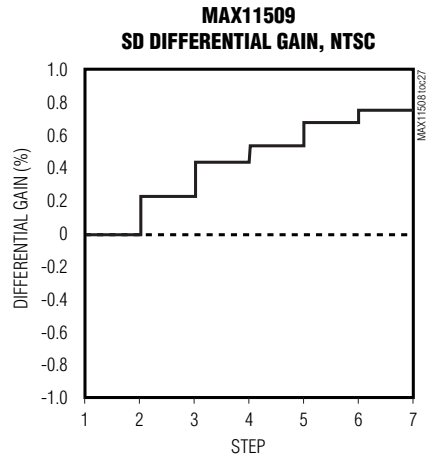
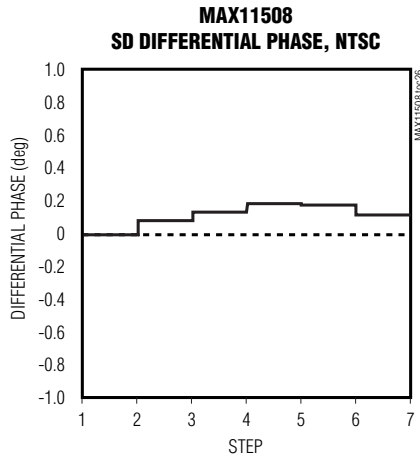
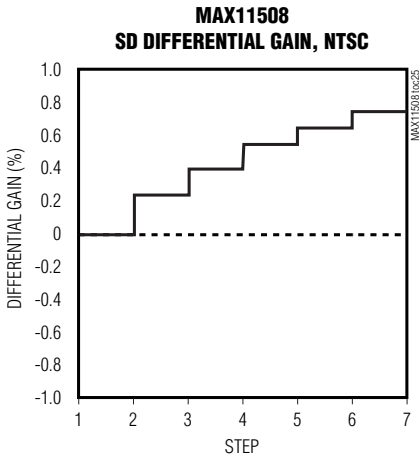
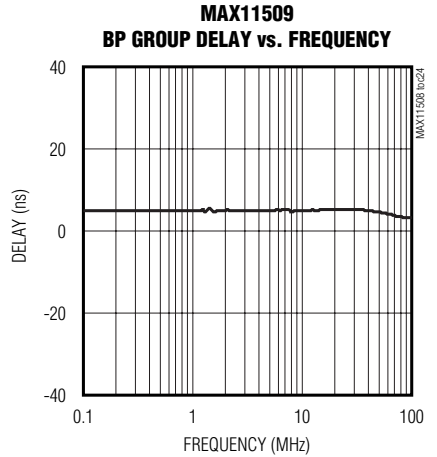
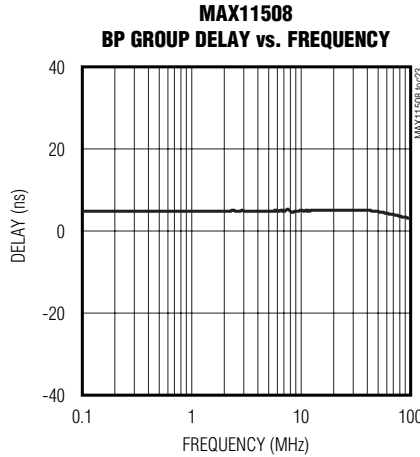
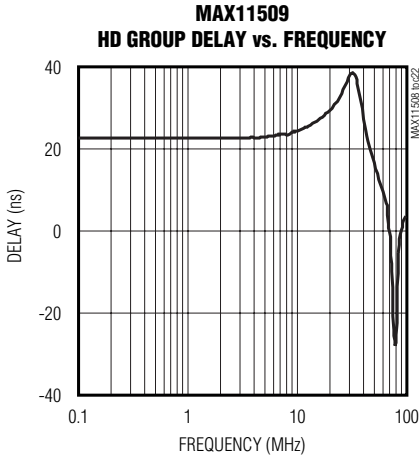
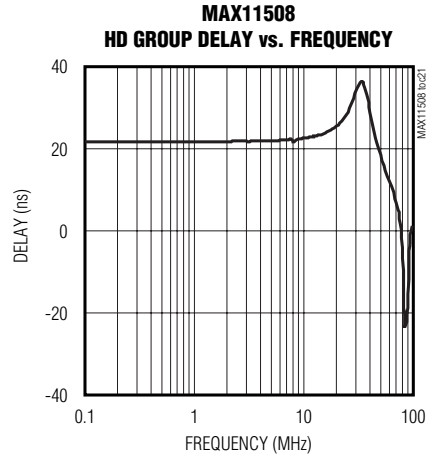
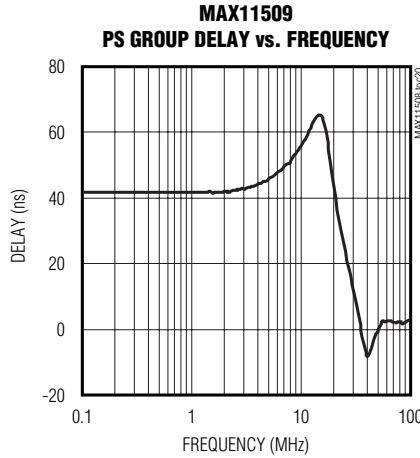
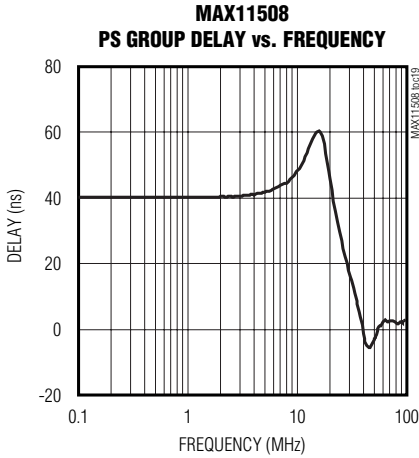

Low-Cost, 3-Channel, HD/PS/SD/BP Video Filters with Buffer

Typical Operating Characteristics (continued)

($V_{CC} = 5V$, $R_L = 150\Omega$ to GND, output DC-coupled, $T_A = +25^\circ C$, unless otherwise noted.)

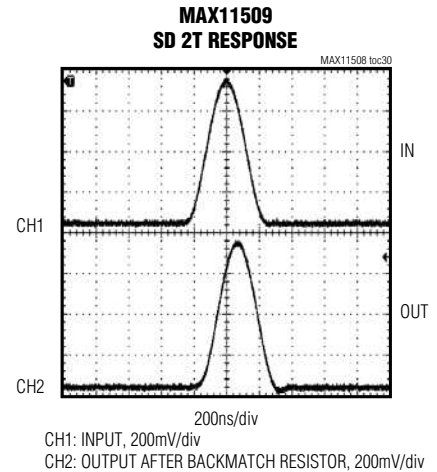
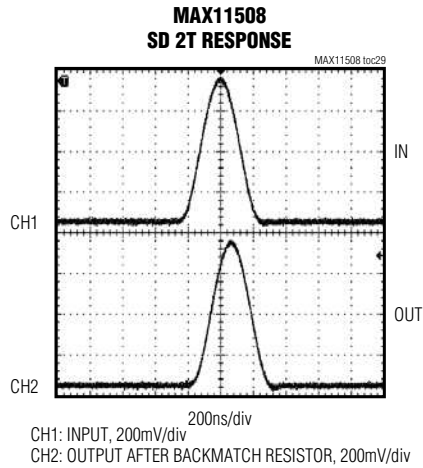
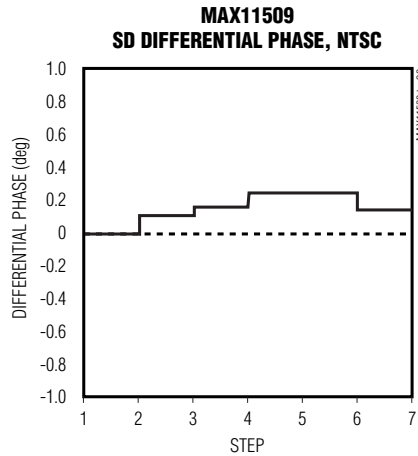

MAX11508/MAX11509

Pin Description

PIN	NAME	FUNCTION
1	V_{CC}	Power-Supply Input
2	FSEL0	Frequency-Select Input. LSB for bandwidth selection.
3	Y/G_IN	Video Input Channel 1
4	Pb/B_IN	Video Input Channel 2
5	Pr/R_IN	Video Input Channel 3
6	BIAS	Bias Control Digital Input. Enables voltage bias for the Pb/B and Pr/R channels. Force BIAS low to enable voltage bias and disable the input clamps. Force BIAS high to disable voltage bias and enable the input clamps.
7, 14	N.C.	No Connection. Not internally connected.
8	GND	Ground
9	SHDN	Shutdown Digital Input. SHDN places the device into a powered-down state. Force SHDN low to enable shutdown. Force SHDN high for normal operation.
10	Pr/R_OUT	Video Output Channel 3
11	Pb/B_OUT	Video Output Channel 2
12	Y/G_OUT	Video Output Channel 1
13	FSEL1	Frequency Select Input. MSB for bandwidth selection.

Low-Cost, 3-Channel, HD/PS/SD/BP Video Filters with Buffer

Detailed Description

The MAX11508/MAX11509 integrated filters offer 3 channels of SD, PS, or HD video, and include a bypass mode useful for high-bandwidth 1080p and RGB video signals. The MAX11508 6th-order lowpass filters provide -3dB bandwidths of 9MHz (SD), 16MHz (PS), 33MHz (HD), and 60MHz (BP). The MAX11509 6th-order lowpass filters provide -3dB bandwidths of 10MHz (SD), 17MHz (PS), 34MHz (HD), and 60MHz (BP).

Two control inputs, FSEL0 and FSEL1, select the filter mode for all filters (Table 1). Input bias circuitry on 2 filter channels can be enabled through the BIAS input to offer simple connection to bipolar video signals such as C, Pb, and Pr. Shutdown mode reduces device current to 1µA (typ) and is enabled by forcing SHDN low. Figure 1 shows a simplified block diagram of the MAX11508/MAX11509.

The MAX11508 provides a flat passband response and the MAX11509 provides a +0.8dB high-frequency boost at 5MHz (SD), 8.5MHz (PS), and 20MHz (HD) to help with system rolloff. No frequency boost is included in bypass mode. Typical voltage waveforms are shown in Figures 2 and 3.

Inputs

Transparent Clamps

All inputs feature transparent clamps to allow either AC- or DC-coupling of the inputs. The clamp remains inactive while the input signal is above ground, offering true DC input coupling. When the signal goes below ground, as is the case when it is AC-coupled, the clamp sets the sync tip close to the ground level.

Input Coupling

The choice of AC- or DC-coupling the input depends on the video source. Many DACs have a current output and are terminated to ground with a resistor; such signals are conveniently DC-coupled. Use AC-coupling when the DC level of the video signal is unknown or outside the specified input range of the MAX11508/MAX11509, such as SCART or VCC-terminated DAC outputs. A bias network within 2 channels of the MAX11508/MAX11509, for use with bipolar signals,

connects to the input node when BIAS is forced low. Figures 4 and 5 show how the bias network operates.

DC-Coupled Inputs

When the input is DC-coupled, the voltage must remain above zero, but not to exceed 1.4V (typ).

AC-Coupling and BIAS

When the input is AC-coupled, the transparent clamps are active and set the lowest point of the signal at ground. This is appropriate for unipolar signals such as CVBS, Y, R, G, or B, with sync pulses (Figure 4). Force BIAS high when coupling unipolar signals.

For bipolar signals, such as Pb and Pr, a bias network is provided within the MAX11508/MAX11509 for inputs Pb/B_IN and Pr/R_IN. Force BIAS low to connect the bias network to these inputs (Figure 5). The internal network biases AC-coupled inputs to a fixed DC voltage, typically 0.59V, to ensure that the transparent clamp remains off.

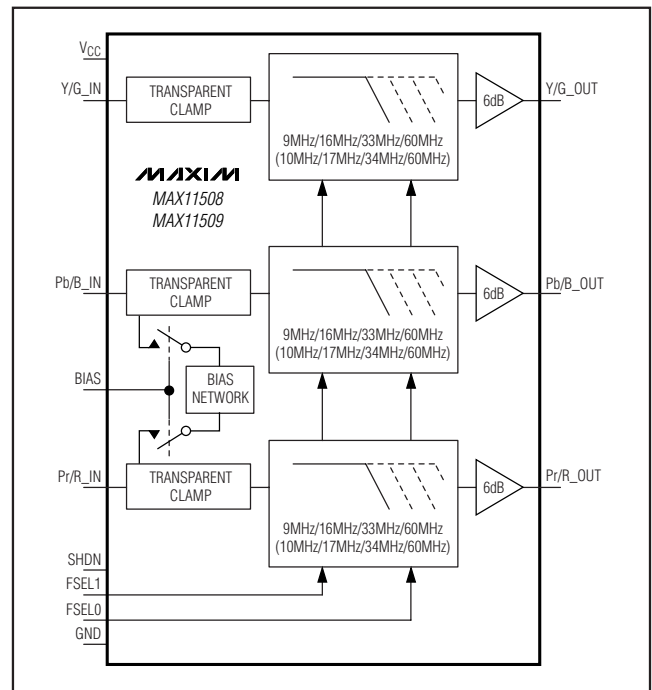

Figure 1. Block Diagram

Table 1. Frequency-Selection Truth Table

CONTROL INPUTS		FILTER -3dB FREQUENCY (MHz)		OPERATING MODE
FSEL1	FSEL0	MAX11508	MAX11509	
0	0	9	10	Standard definition
0	1	16	17	Progressive scan
1	0	33	34	High definition
1	1	60	60	Bypass

Low-Cost, 3-Channel, HD/PS/SD/BP Video Filters with Buffer

MAX11508/MAX11509

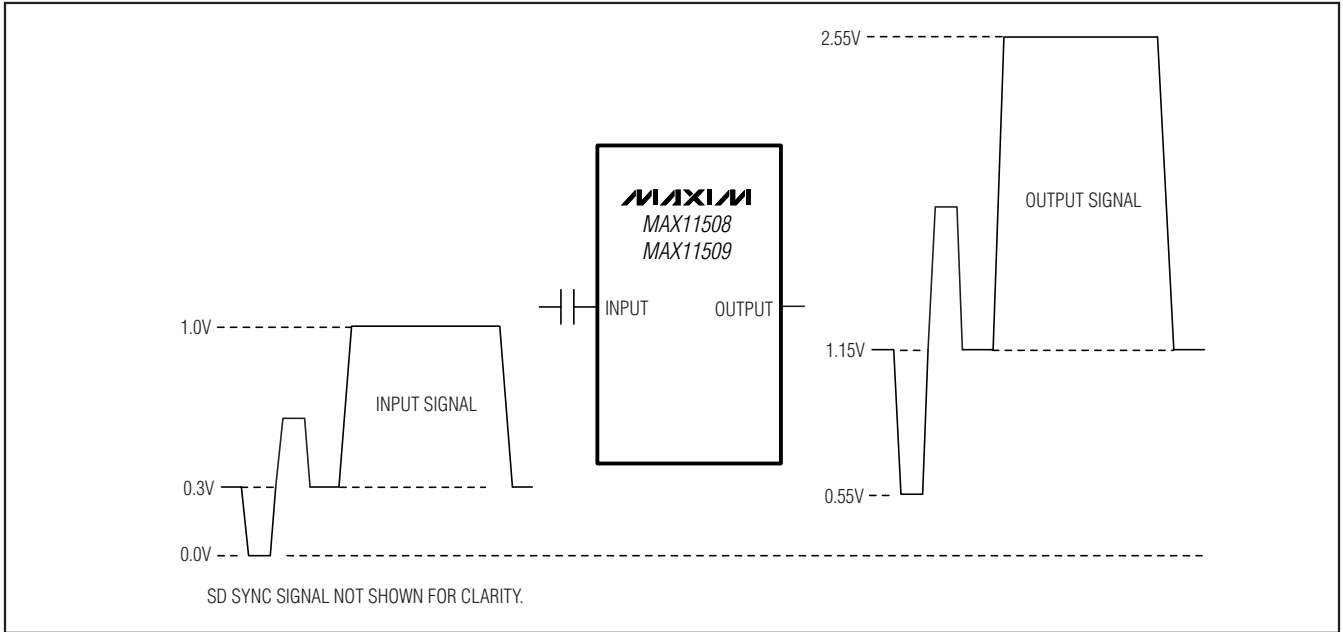

Figure 2. Typical AC-Coupled Signal

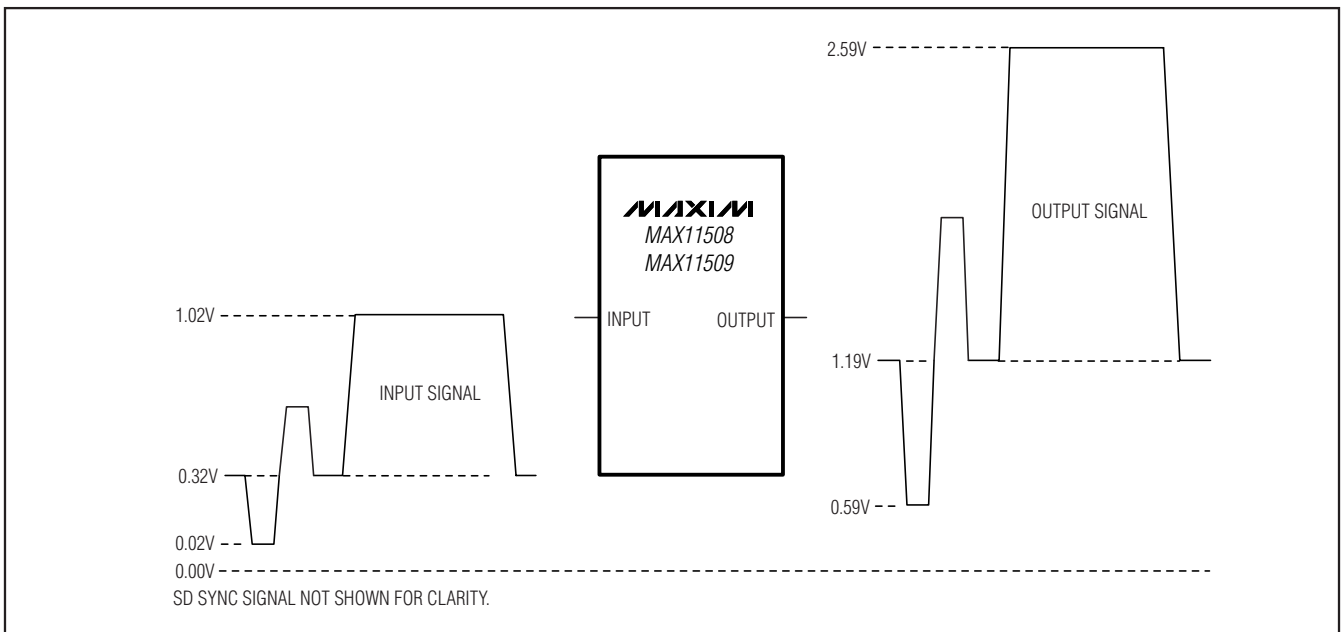

Figure 3. Typical DC-Coupled Signal

Low-Cost, 3-Channel, HD/PS/SD/BP Video Filters with Buffer

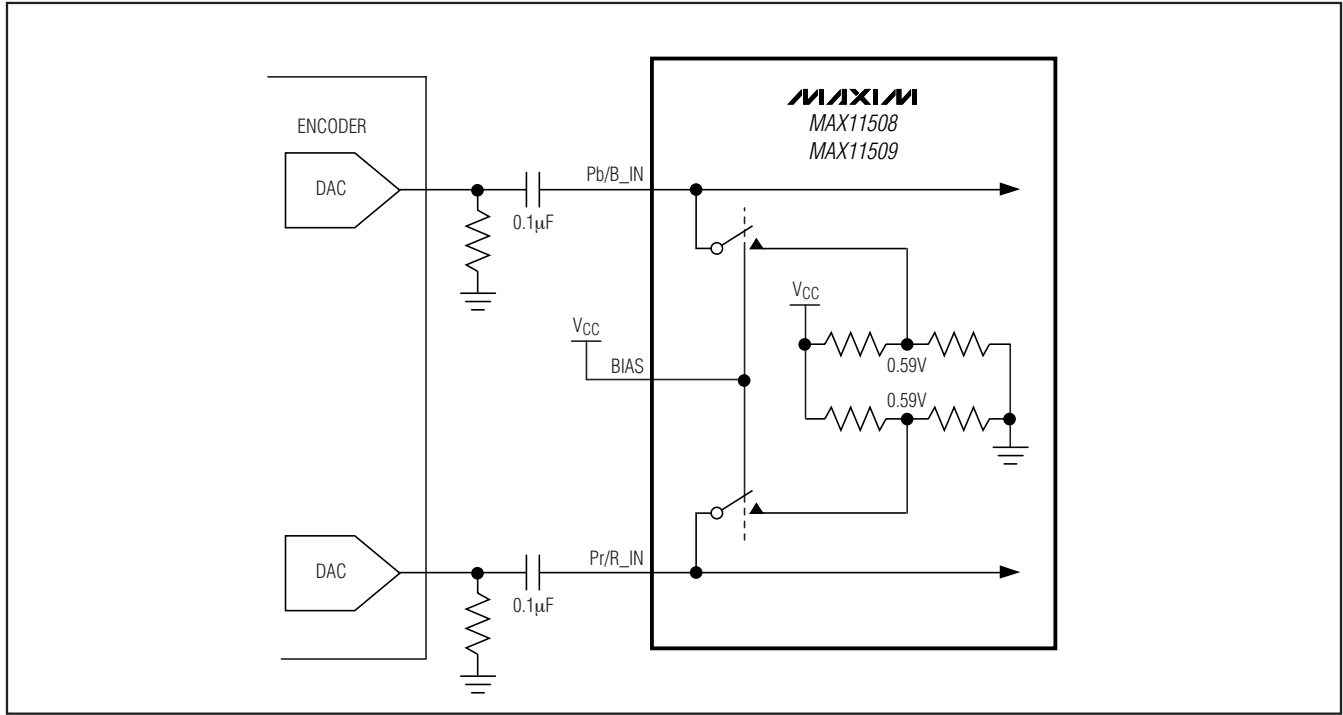

Figure 4. Simple AC-Coupling and BIAS Control for Unipolar Signals (CVBS, Y, R, G, B)

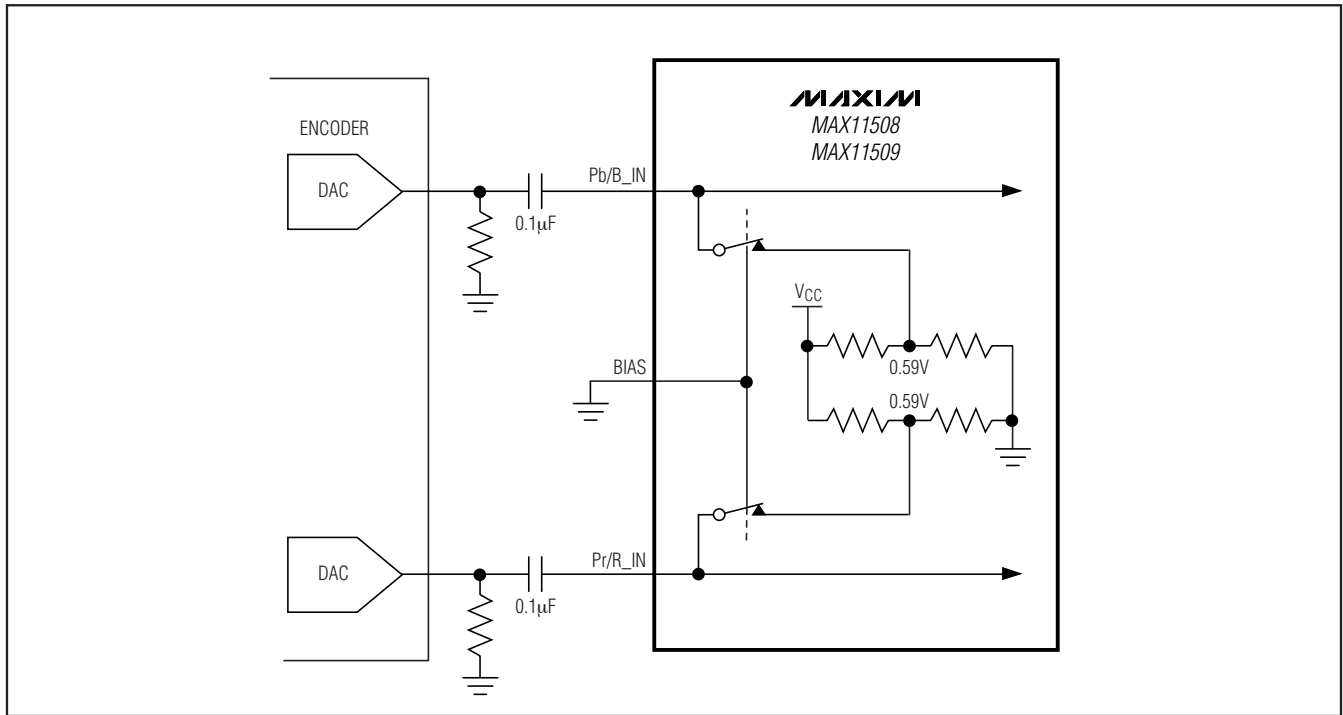

Figure 5. AC-Coupling and BIAS Control for Bipolar Signals (C, Pb, Pr)

Low-Cost, 3-Channel, HD/PS/SD/BP Video Filters with Buffer

MAX11508/MAX11509

Filters

The MAX11508 filter characteristic provides excellent time-domain response with low overshoot and guarantees minimal attenuation in the passband. The MAX11509 filters offer a small gain peaking response to counter system rolloff.

Select filter frequency with inputs FSEL0 and FSEL1, as shown in Table 1.

Standard-Definition (SD) Filters

The MAX11508 SD filters have a 9MHz (typ) -3dB frequency, while the MAX11509 SD filters offer a 10MHz (typ) -3dB frequency and a +0.8dB high-frequency boost at 5MHz (typ). Both devices have a stopband attenuation of +48dB (typ) at 27MHz.

Progressive-Scan (PS) Filters

The MAX11508 PS filters have a 16MHz (typ) -3dB frequency, while the MAX11509 PS filters offer a 17MHz (typ) -3dB frequency and a +0.8dB high-frequency boost at 8.5MHz (typ). Both devices have a stopband attenuation of +44dB (typ) at 54MHz.

High-Definition (HD) Filters

The MAX11508 HD filters have a 33MHz (typ) -3dB frequency, while the MAX11509 HD filters offer a 34MHz (typ) -3dB frequency and a +0.8dB high-frequency boost at 20MHz (typ). Both devices have a stopband attenuation of +45dB (typ) at 74.25MHz.

Bypassing the Filters

The MAX11508/MAX11509 filter bypass circuitry offers a 60MHz (typ) -3dB frequency. Bypassed filters offer no gain peaking.

Output Buffer

The MAX11508/MAX11509 feature output buffers with +6dB gain that drive a standard 150Ω video load at 2V_{P-P}. A typical load consists of a 75Ω backmatch resistor, an optional 220μF or larger coupling capacitor, and a 75Ω termination resistor.

An offset of 550mV is added at the output. The offset ensures that the blanking level on the output is less than 1V after the backmatch resistor, thus meeting digital TV specifications allowing the devices to drive video loads directly without using costly AC-coupling capacitors. The basic output voltage equation of all filters is:

$$V_{OUT} = (2 \times V_{IN}) + 0.55V$$

Typical voltage waveforms are shown in Figures 2 and 3.

Shutdown

Forcing digital input SHDN low places the MAX11508/MAX11509 into low-power shutdown mode. In shutdown, the device consumes only 1μA (typ), and the outputs are internally connected to GND through 1.58kΩ resistors. In shutdown, the input clamps are disabled and the inputs are internally connected to GND through 350kΩ resistors. When shutdown is forced low while BIAS is low, the bias network remains active, but the bias voltage changes from its nominal 0.59V to 0.475V (typ).

Applications Information

Output Considerations

DC- or AC-couple the MAX11508/MAX11509 outputs. These devices, with +6dB gain, are typically connected to a 75Ω series backmatch resistor followed by a video cable. Choose an AC-coupling capacitor value that ensures that the lowest frequency content in the video signal is passed and the field-time distortion is kept within desired limits when using an AC connection. The selection of this value is a function of the input impedance, and more importantly, the input leakage of the circuit being driven. Common industry practice is to use a 220μF or larger capacitor.

The MAX11508/MAX11509 outputs are fully protected against short circuits to ground. The short-circuit protection circuitry limits the output current to 75mA (typ) per output. Shorting more than one output to ground simultaneously may exceed the maximum package power dissipation.

PCB Layout Recommendations

Connect the power and ground traces to large copper areas to enhance power dissipation. Bypass V_{CC} to GND with 0.1μF and 1.0μF capacitors. Place the 0.1μF capacitor closest to V_{CC}. Use surface-mount capacitors for their low inductance. Place traces carrying video signals appropriately to avoid mutual coupling. When inputs are AC-coupled, place the capacitors as close as possible to the device and keep traces short to minimize parasitic capacitance and inductance. Refer to the MAX11508/MAX11509 evaluation kit data sheet for PCB layout.

Chip Information

PROCESS: BiCMOS

Low-Cost, 3-Channel, HD/PS/SD/BP Video Filters with Buffer

Typical Operating Circuit

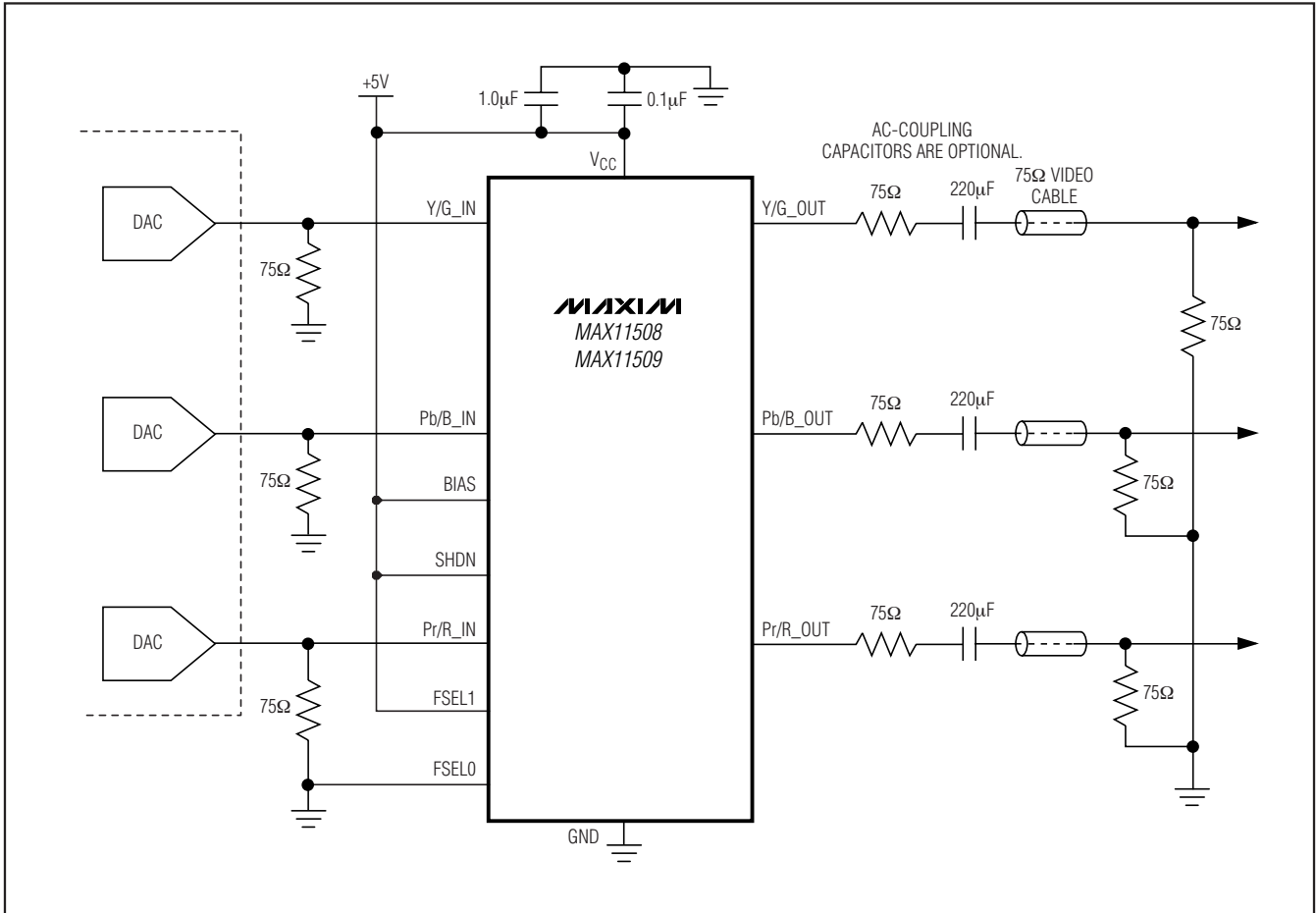

Package Information

For the latest package outline information and land patterns, go to www.maxim-ic.com/packages.

PACKAGE TYPE	PACKAGE CODE	DOCUMENT NO.
14 TSSOP	U14+1	21-0066

Maxim cannot assume responsibility for use of any circuitry other than circuitry entirely embodied in a Maxim product. No circuit patent licenses are implied. Maxim reserves the right to change the circuitry and specifications without notice at any time.

12 **Maxim Integrated Products, 120 San Gabriel Drive, Sunnyvale, CA 94086 408-737-7600**

© 2008 Maxim Integrated Products

MAXIM is a registered trademark of Maxim Integrated Products, Inc.