

## FEATURES

- Very small plastic SMD package.
- High switching speed:max.4ns
- Continuous reverse voltage:max.100v
- Repetitive peak reverse voltage:max.100v
- Repetitive peak forward current:max.500mA

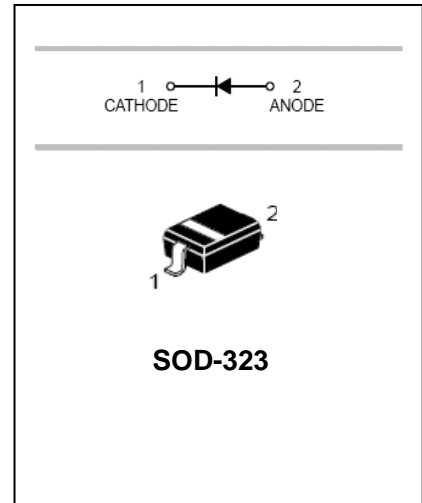

## APPLICATIONS

- Surface mount fast switching diode

## ORDERING INFORMATION

Type No.	Marking	Package Code
BAS316	A6	SOD-323

## MAXIMUM RATING @ Ta=25°C unless otherwise specified

Characteristic	Symbol	Value	Unit
DC Reverse Voltage	$V_R$	100	V
Forward Current	$I_F$	300	mA
Power Dissipation	$P_d$	200	mW
Junction and Storage Temperature Range	$T_j, T_{STG}$	-65 to +150	°C

# Diode Semiconductor Korea

Silicon Epitaxial Planar Diode

**BAS316**

## ELECTRICAL CHARACTERISTICS @ Ta=25°C unless otherwise specified

Characteristic	Symbol	Min	Max	Unit	Test Condition
Reverse Breakdown Voltage	$V_{(BR)R}$	100	-	V	$I_R=100\mu A$
Forward Voltage	$V_F$	0.62	0.715 0.855 1.0 1.25	V	$I_F=1.0mA$ $I_F=10mA$ $I_F=50mA$ $I_F=150mA$
Reverse Current	$I_R$	-	1.0 0.03	$\mu A$	$V_R=75V$ $V_R=25V$
Capacitance between terminals	$C_T$	-	1.5	pF	$V_R=0, f=1.0MHz$
Reverse Recovery Time	$t_{rr}$	-	4.0	ns	$I_F=I_R=10mA, R_L=100\Omega$

## TYPICAL CHARACTERISTICS @ Ta=25°C unless otherwise specified

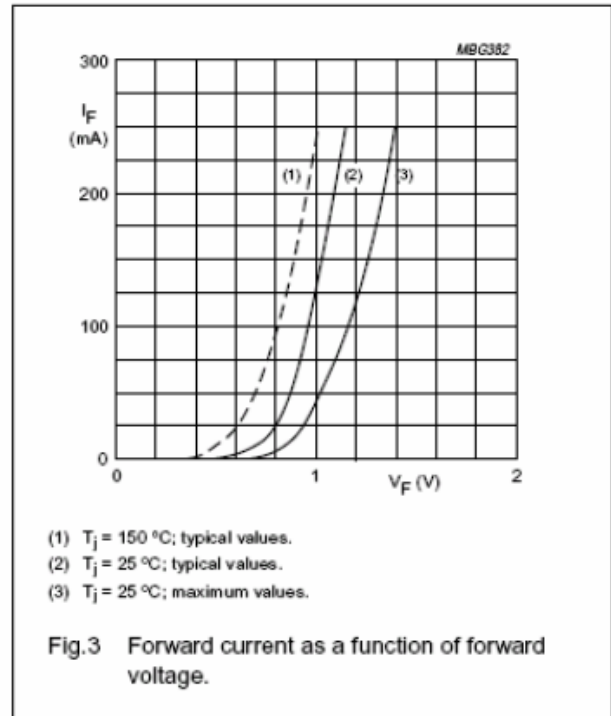
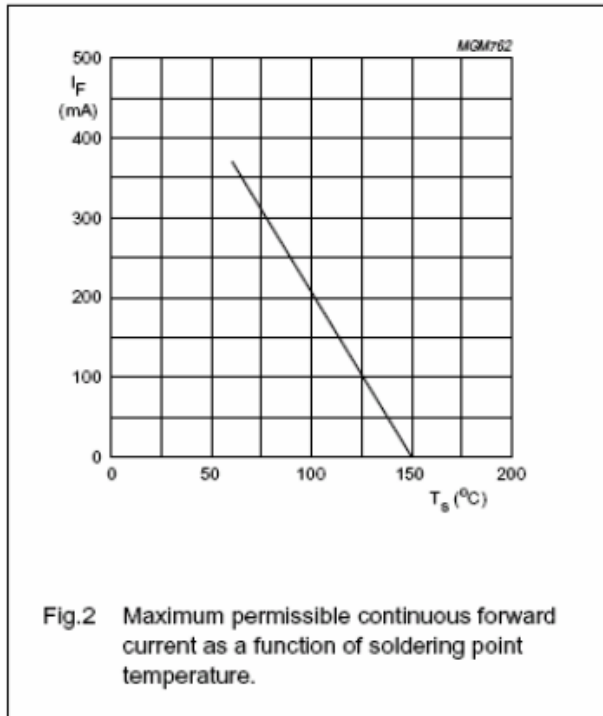

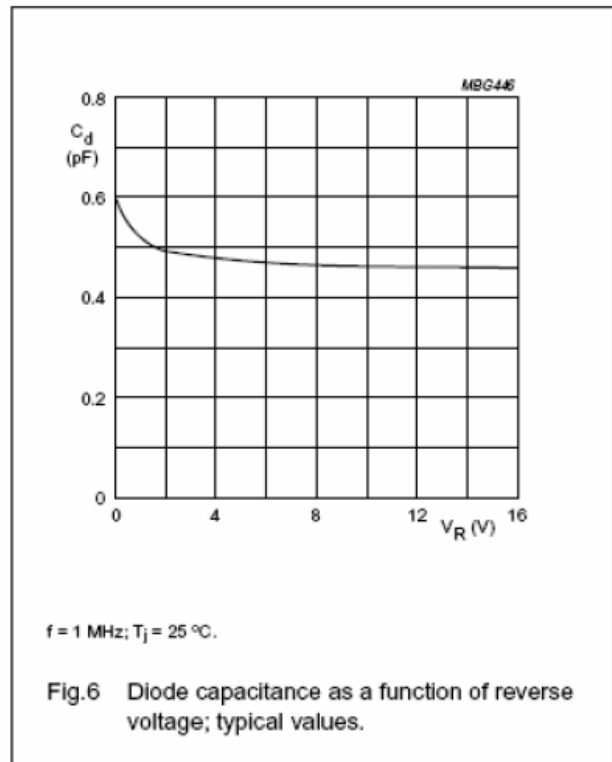
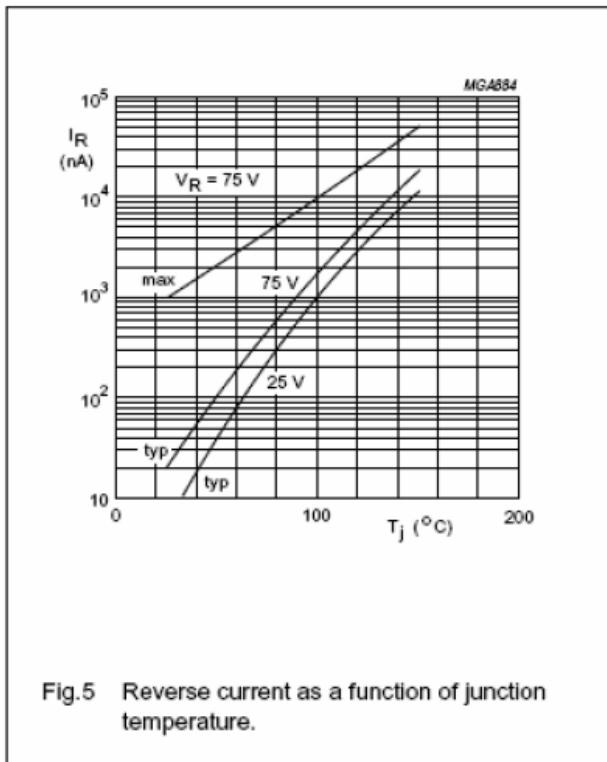
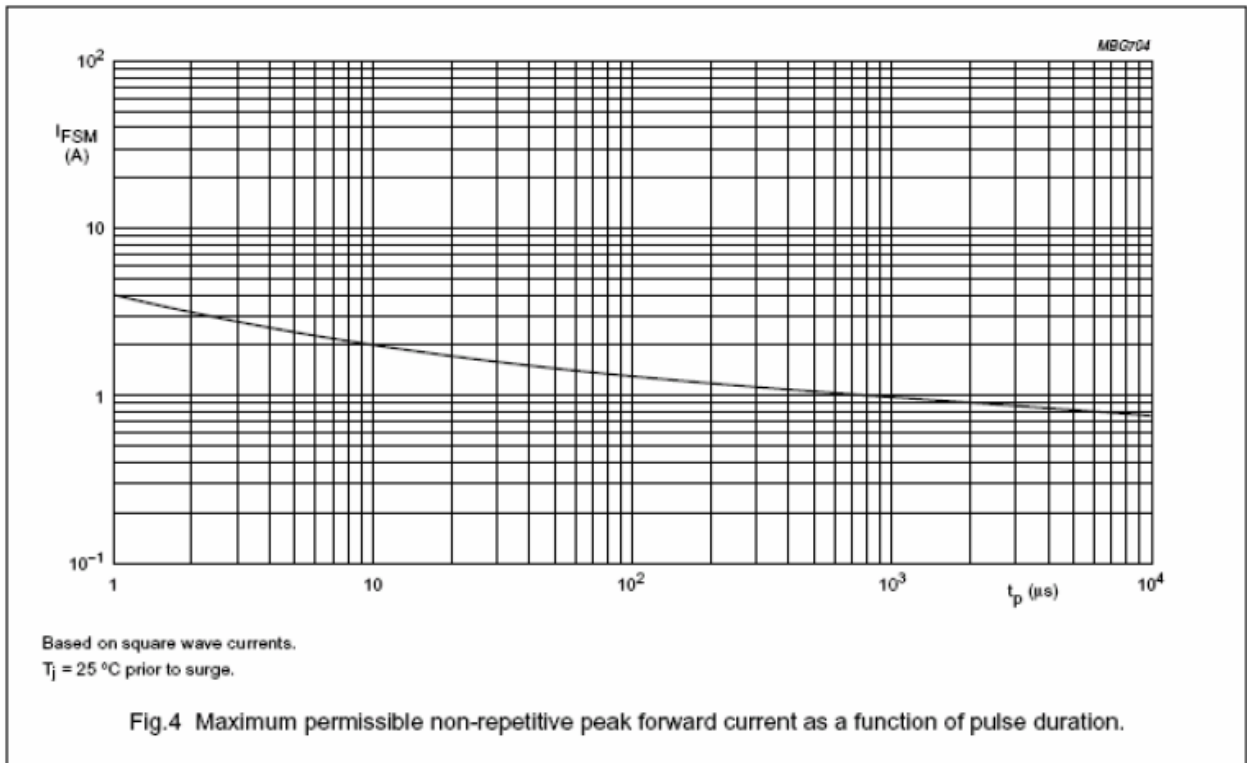

**PACKAGE OUTLINE**

Plastic surface mounted package

SOD-323

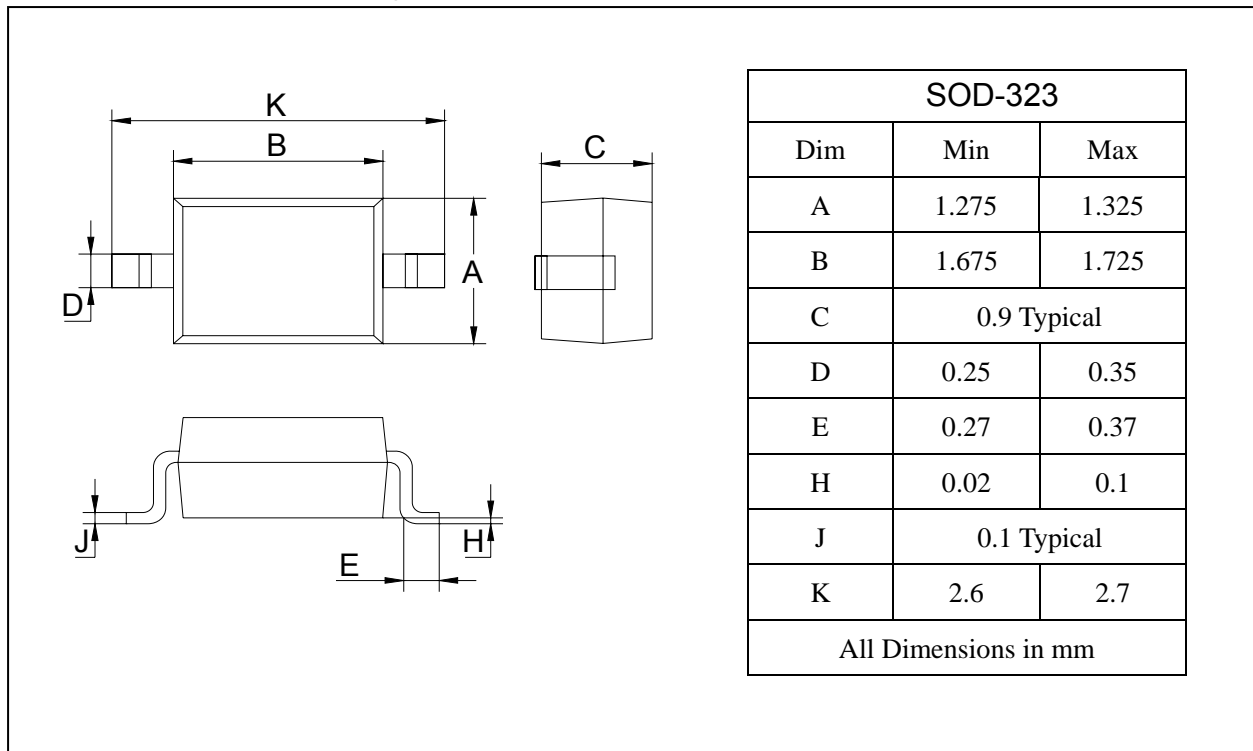

**SOLDERING FOOTPRINT**

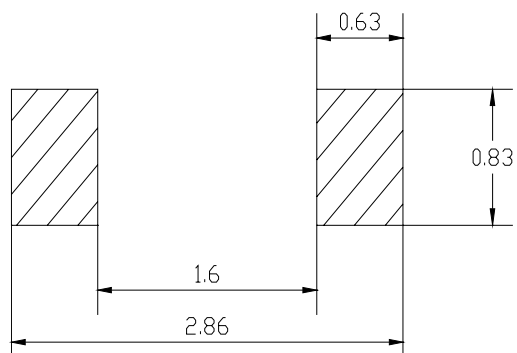

Unit : mm

**PACKAGE INFORMATION**

Device	Package	Shipping
BAS316	SOD-323	3000/Tape&Reel