

### FEATURES

#### High common-mode voltage range

4 V to 80 V operating  
-0.3 V to +85 V survival

#### Buffered output voltage

Gain = 60 V/V

#### Wide operating temperature range: -40°C to +125°C

#### Excellent ac and dc performance

±100 nV/°C typical offset drift  
±50 µV typical offset  
±5 ppm/°C typical gain drift  
110 dB typical CMRR at dc

### APPLICATIONS

#### High-side current sensing

48 V telecom  
Power management  
Base stations  
Unidirectional motor control  
Precision high voltage current sources

### GENERAL DESCRIPTION

The AD8219 is a high voltage, high resolution, current shunt amplifier. It features a set gain of 60 V/V, with a maximum ±0.3% gain error over the entire temperature range. The buffered output voltage directly interfaces with any typical converter. The AD8219 offers excellent input common-mode rejection from 4 V to 80 V. The AD8219 performs unidirectional current measurements across a shunt resistor in a variety of industrial and telecom applications including motor control, power management, and base station power amplifier bias control.

### FUNCTIONAL BLOCK DIAGRAM

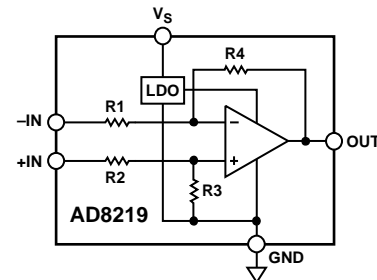

Figure 1.

08415-001

The AD8219 offers breakthrough performance throughout the -40°C to +125°C temperature range. It features a zero drift core, which leads to a typical offset drift of ±100 nV/°C throughout the operating temperature and common-mode voltage range. Special attention is devoted to output linearity being maintained throughout the input differential voltage range, regardless of the common-mode voltage present, while the typical input offset voltage is ±50 µV.

The AD8219 is offered in a 8-lead MSOP package.

#### Rev. A

Information furnished by Analog Devices is believed to be accurate and reliable. However, no responsibility is assumed by Analog Devices for its use, nor for any infringements of patents or other rights of third parties that may result from its use. Specifications subject to change without notice. No license is granted by implication or otherwise under any patent or patent rights of Analog Devices. Trademarks and registered trademarks are the property of their respective owners.

## TABLE OF CONTENTS

Features .....	1	Amplifier Core.....	10
Applications.....	1	Supply Connections .....	10
Functional Block Diagram .....	1	Output Clamping .....	10
General Description .....	1	Output Linearity .....	10
Revision History .....	2	Applications Information .....	11
Specifications.....	3	High-Side Current Sensing .....	11
Absolute Maximum Ratings.....	4	Motor Control Current Sensing .....	11
ESD Caution.....	4	Outline Dimensions .....	12
Pin Configuration and Function Descriptions.....	5	Ordering Guide .....	12
Typical Performance Characteristics .....	6		
Theory of Operation .....	10		

## REVISION HISTORY

### 2/11—Rev. 0 to Rev. A

Changes to Features Section.....	1
Changes to Amplifier Core Section .....	10
Moved Output Linearity Section into Theory of Operation Section.....	10

### 1/11—Revision 0: Initial Version

## SPECIFICATIONS

$T_{OPR} = -40^{\circ}\text{C}$  to  $+125^{\circ}\text{C}$ ,  $T_A = 25^{\circ}\text{C}$ ,  $R_L = 25\text{ k}\Omega$ , input common-mode voltage ( $V_{CM}$ ) = 4 V ( $R_L$  is the output load resistor), unless otherwise noted.

Table 1.

Parameter	Min	Typ	Max	Unit	Test Conditions/Comments
<b>GAIN</b>					
Initial Accuracy		60		V/V	$V_O \geq 0.1\text{ V dc}$ , $T_A$ $T_{OPR}$
Accuracy over Temperature		$\pm 0.1$	$\pm 0.3$	%	
Gain vs. Temperature		$\pm 5$		ppm/ $^{\circ}\text{C}$	
<b>VOLTAGE OFFSET</b>					
Offset Voltage (RTI <sup>1</sup> )			$\pm 200$	$\mu\text{V}$	$25^{\circ}\text{C}$
Over Temperature (RTI <sup>1</sup> )			$\pm 300$	$\mu\text{V}$	$T_{OPR}$
Offset Drift		$\pm 100$		nV/ $^{\circ}\text{C}$	$T_{OPR}$
<b>INPUT</b>					
Bias Current <sup>2</sup>		130	220	$\mu\text{A}$	$T_A$ , input common mode = 4 V, $V_S = 4\text{ V}$ $T_{OPR}$
Common-Mode Input Voltage Range	4		80	V	
Differential Input Voltage Range <sup>3</sup>	0		83	mV	
Common-Mode Rejection (CMRR)	94	110		dB	
<b>OUTPUT</b>					
Output Voltage Range Low <sup>4</sup>	0.01			V	$T_A$
Output Voltage Range High <sup>4</sup>			$V_S - 0.1$	V	$T_A$
Output Impedance		2		$\Omega$	
<b>DYNAMIC RESPONSE</b>					
Small Signal $-3\text{ dB}$ Bandwidth		500		kHz	
Slew Rate		1		V/ $\mu\text{s}$	
<b>NOISE</b>					
0.1 Hz to 10 Hz, (RTI <sup>1</sup> )		2.3		$\mu\text{V p-p}$	
Spectral Density, 1 kHz, (RTI <sup>1</sup> )		110		nV/ $\sqrt{\text{Hz}}$	
<b>POWER SUPPLY</b>					
Operating Range	4		80	V	$V_S$ input range
Quiescent Current Over Temperature <sup>5</sup>			800	$\mu\text{A}$	
Power Supply Rejection Ratio (PSRR)	100	110		dB	$T_{OPR}$
<b>TEMPERATURE RANGE</b>					
For Specified Performance	$-40$		$+125$	$^{\circ}\text{C}$	

<sup>1</sup> RTI = referred to input.

<sup>2</sup> Refer to Figure 8 for further information on the input bias current. This current varies based on the input common-mode voltage. Additionally, the input bias current flowing to the +IN pin is also the supply current to the internal LDO.

<sup>3</sup> The differential input voltage is specified as 83 mV maximum because the output is internally clamped to 5.6 V. See the Output Clamping section.

<sup>4</sup> See Figure 19 and Figure 20 for further information on the output range of the AD8219 with various loads. The AD8219 output clamps to a maximum voltage of 5.6 V when the voltage at Pin +IN is greater than 5.6 V. When the voltage at +IN is less than 5.6 V, the output reaches a maximum value of ( $V_S - 100\text{ mV}$ ).

<sup>5</sup>  $V_S$  (Pin 2) can be connected to a separate supply ranging from 4 V to 80 V, or it can be connected to the positive input pin (+IN) of the AD8219. In this mode, the current drawn varies with increasing voltage. See Figure 9.

## ABSOLUTE MAXIMUM RATINGS

Table 2.

Parameter	Rating
Maximum Input Voltage (+IN, -IN to GND)	-0.3 V to +85 V
Differential Input Voltage (+IN to -IN)	±5 V
Human Body Model (HBM) ESD Rating	±1000 V
Operating Temperature Range (T <sub>OPR</sub> )	-40°C to +125°C
Storage Temperature Range	-65°C to +150°C
Output Short-Circuit Duration	Indefinite

Stresses above those listed under Absolute Maximum Ratings may cause permanent damage to the device. This is a stress rating only; functional operation of the device at these or any other conditions above those indicated in the operational section of this specification is not implied. Exposure to absolute maximum rating conditions for extended periods may affect device reliability.

### ESD CAUTION



**ESD (electrostatic discharge) sensitive device.** Charged devices and circuit boards can discharge without detection. Although this product features patented or proprietary protection circuitry, damage may occur on devices subjected to high energy ESD. Therefore, proper ESD precautions should be taken to avoid performance degradation or loss of functionality.

## PIN CONFIGURATION AND FUNCTION DESCRIPTIONS

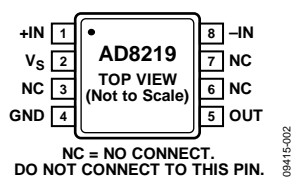

Figure 2. Pin Configuration

Table 3. Pin Function Descriptions

Pin No.	Mnemonic	Description
1	+IN	Noninverting Input.
2	V <sub>S</sub>	Supply Pin. Bypass with a standard 0.1 $\mu$ F capacitor.
3	NC	Do Not Connect to This Pin.
4	GND	Ground.
5	OUT	Output.
6	NC	Do Not Connect to This Pin.
7	NC	Do Not Connect to This Pin.
8	-IN	Inverting Input.

TYPICAL PERFORMANCE CHARACTERISTICS

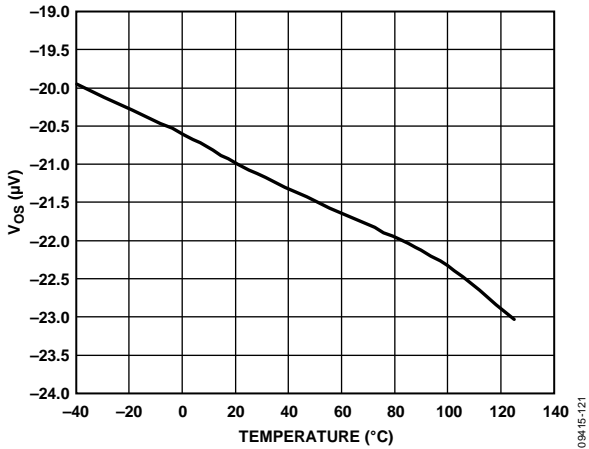

Figure 3. Typical Input Offset vs. Temperature

09415-121

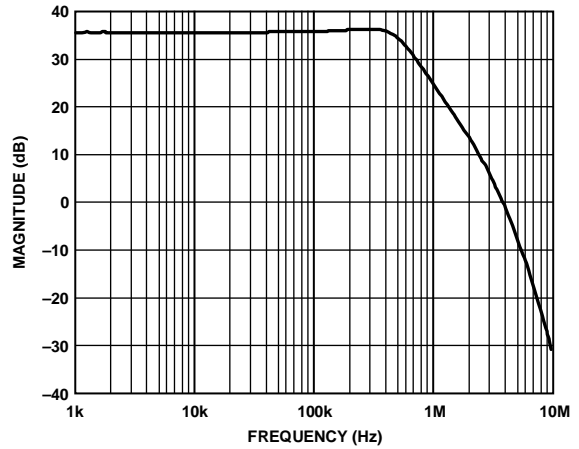

Figure 6. Typical Small Signal Bandwidth ( $V_{OUT} = 200$  mV p-p)

09415-105

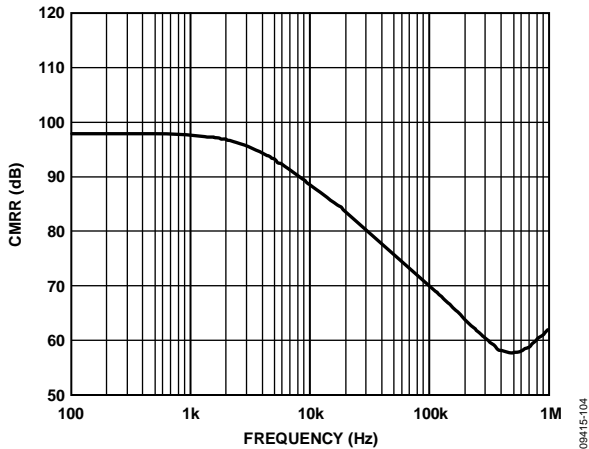

Figure 4. Typical CMRR vs. Frequency

09415-104

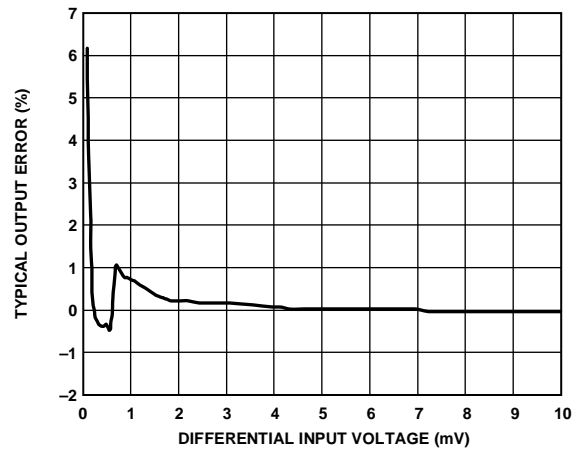

Figure 7. Typical Output Error vs. Differential Input Voltage

09415-128

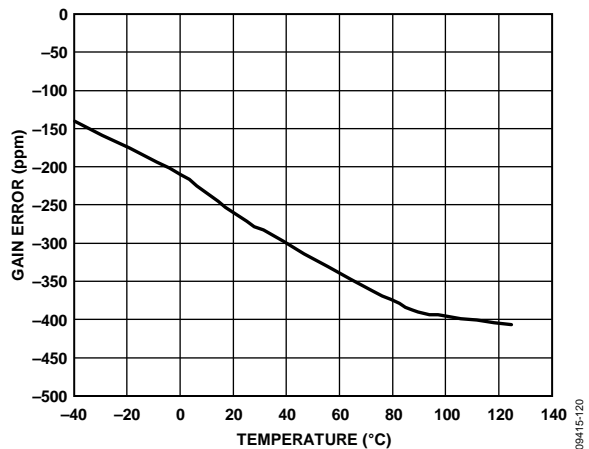

Figure 5. Typical Gain Error vs. Temperature

09415-120

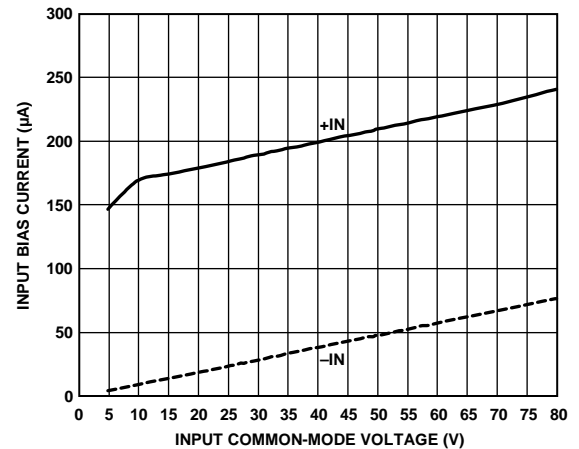

Figure 8. Input Bias Current vs. Input Common-Mode Voltage (Differential Input Voltage = 5 mV) ( $V_S = 5$  V)

09415-101

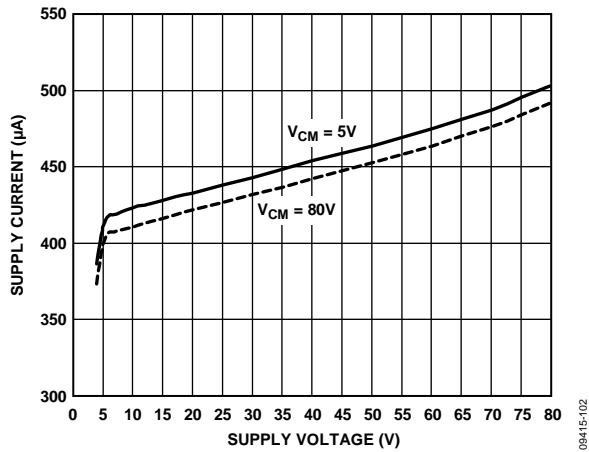

Figure 9. Typical Supply Current vs. Supply Voltage ( $V_S$  Connected to +IN)

09415-102

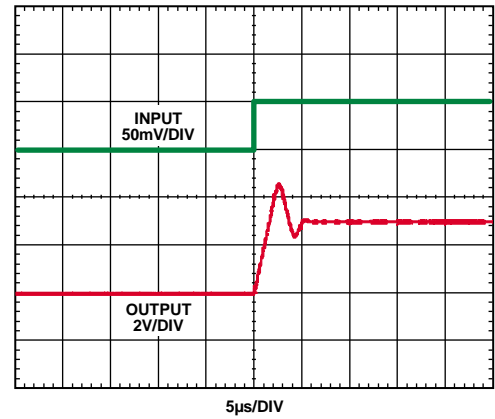

Figure 12. Rise Time (Differential Input = 50 mV)

09415-110

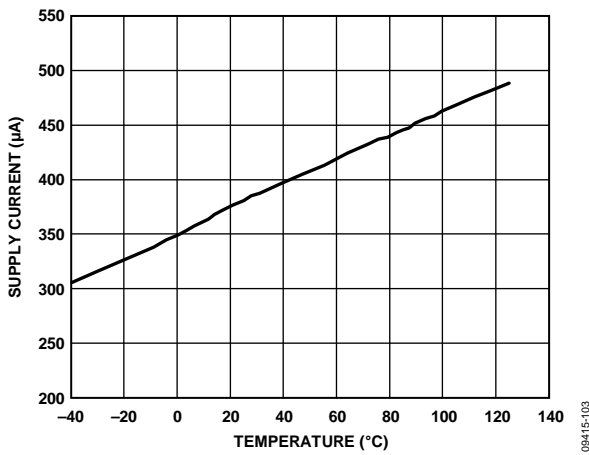

Figure 10. Typical Supply Current Change over Temperature ( $V_S = 5 V$ )

09415-103

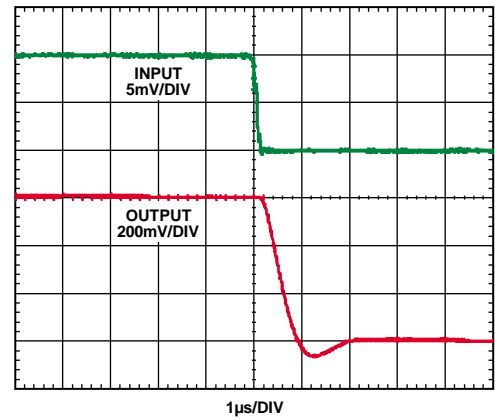

Figure 13. Fall Time (Differential Input = 5 mV)

09415-111

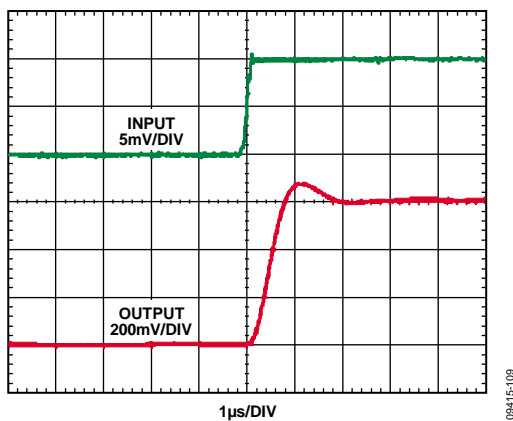

Figure 11. Rise Time (Differential Input = 5 mV)

09415-109

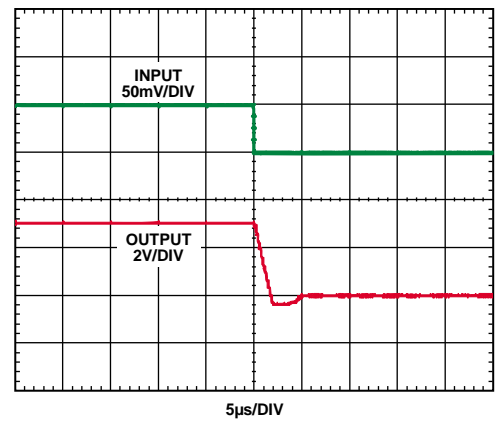

Figure 14. Fall Time (Differential Input = 50 mV)

09415-112

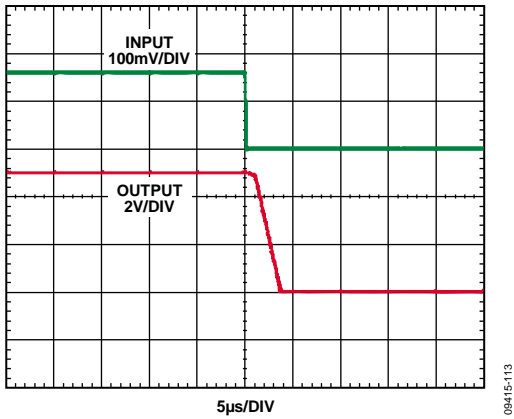

Figure 15. Differential Overload Recovery, Falling

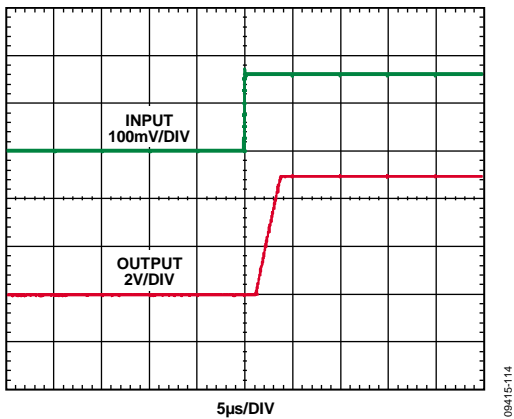

Figure 16. Differential Overload Recovery, Rising

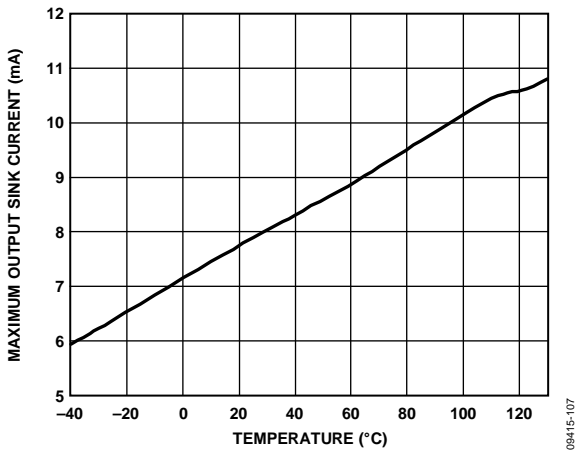

Figure 17. Maximum Output Sink Current vs. Temperature

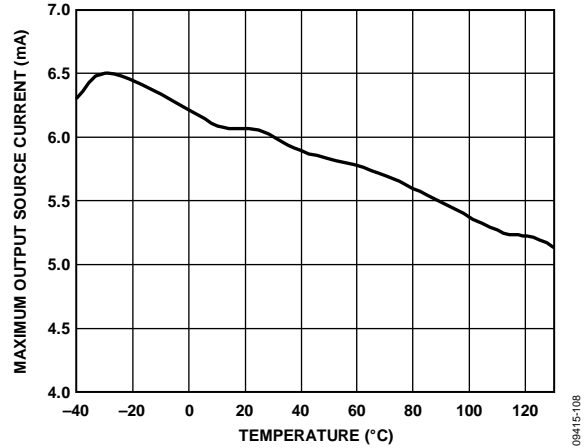

Figure 18. Maximum Output Source Current vs. Temperature

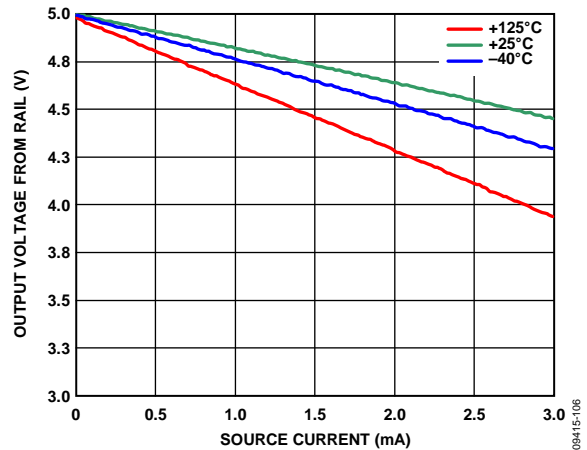

Figure 19. Output Voltage Range vs. Output Source Current ( $V_s = 5\text{ V}$ )

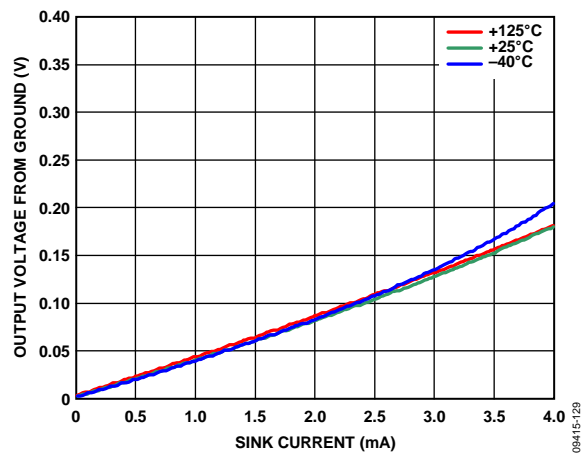

Figure 20. Output Voltage Range From Ground vs. Output Sink Current ( $V_s = 5\text{ V}$ )



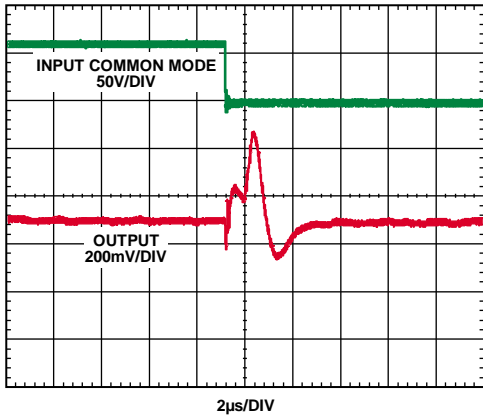

Figure 21. Common-Mode Step Response (Falling)

09415-115

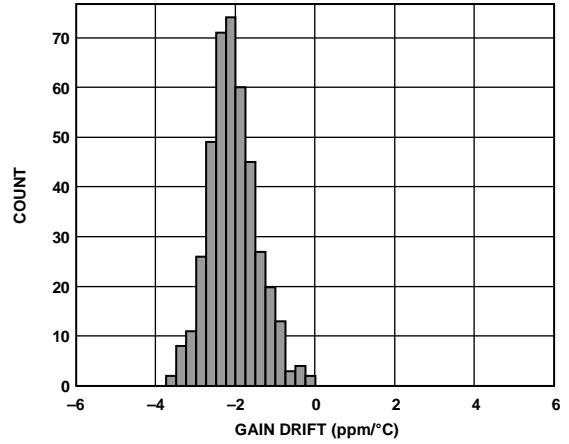

Figure 24. Gain Drift Distribution

09415-119

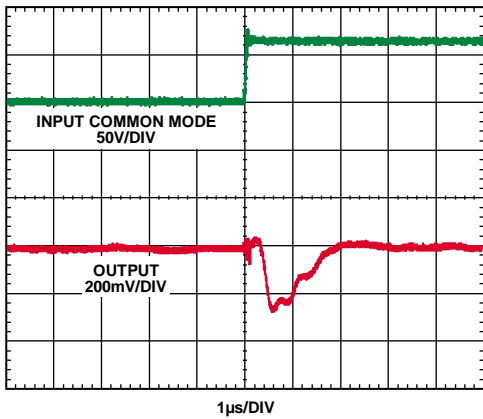

Figure 22. Common-Mode Step Response (Rising)

09415-116

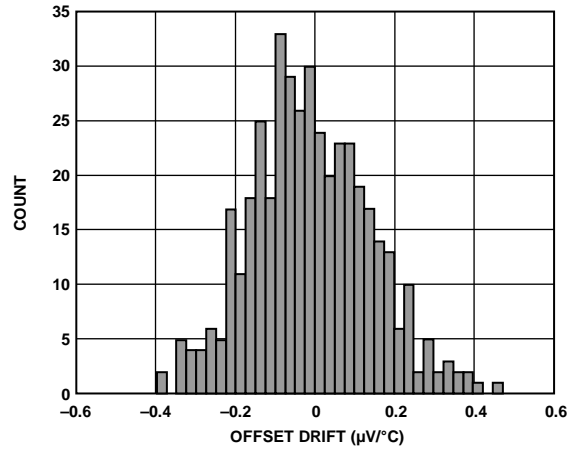

Figure 25. Input Offset Drift Distribution

09415-117

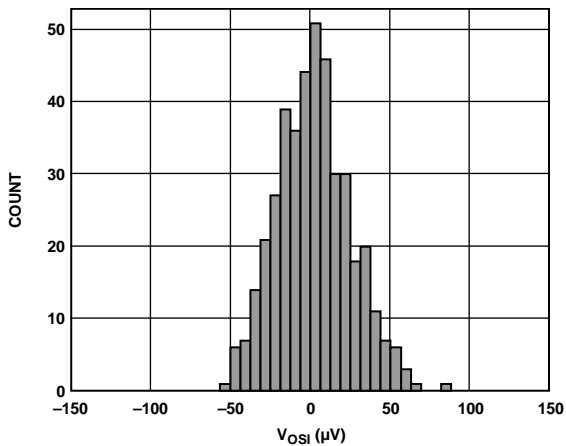

Figure 23. Input Offset Distribution

09415-118

## THEORY OF OPERATION

### AMPLIFIER CORE

In typical applications, the AD8219 amplifies a small differential input voltage generated by the load current flowing through a shunt resistor. The AD8219 rejects high common-mode voltages (up to 80 V) and provides a ground referenced, buffered output that interfaces with an analog-to-digital converter (ADC). Figure 26 shows a simplified schematic of the AD8219.

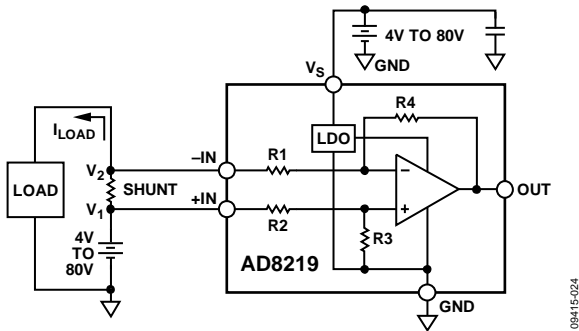

Figure 26. Simplified Schematic

The AD8219 is configured as a difference amplifier. The transfer function is

$$OUT = (R4/R1) \times (V_1 - V_2)$$

Resistors R4 and R1 are matched to within 0.01% and have values of 1.5 MΩ and 25 kΩ, respectively, meaning an input to output total gain of 60 V/V for the AD8219, while the difference at V<sub>1</sub> and V<sub>2</sub> is the voltage across the shunt resistor or V<sub>IN</sub>. Therefore, the input-to-output transfer function for the AD8219 is

$$OUT = (60) \times (V_{IN})$$

The AD8219 accurately amplifies the input differential signal, rejecting high voltage common modes ranging from 4 V to 80 V.

The main amplifier uses a novel zero drift architecture, providing the end user with breakthrough temperature stability. The offset drift is typically less than ±100 nV/°C. This performance leads to optimal accuracy and dynamic range.

### SUPPLY CONNECTIONS

The AD8219 includes an internal LDO, which allows the user to connect the V<sub>S</sub> pin to the inputs, or use a separate supply at Pin 2 (V<sub>S</sub>) to power the device. The input range of the supply pin is equivalent to the input common-mode range of 4 V to 80 V. The user must ensure that V<sub>S</sub> is always connected to the +IN pin or a separate low impedance supply, which can range from 4 V to 80 V. The V<sub>S</sub> pin should not be floating.

### OUTPUT CLAMPING

When the input common-mode voltage in the application is above 5.6 V, the internal LDO output of the AD8219 also reaches its maximum value of 5.6 V, which is the maximum output range of the AD8219. Because in typical applications the output interfaces with a converter, clamping the AD8219 output voltage to 5.6 V ensures the ADC input is not damaged due to excessive overvoltage.

### OUTPUT LINEARITY

In all current sensing applications where the common-mode voltage can vary significantly, it is important that the current sensor maintain the specified output linearity, regardless of the input differential or common-mode voltage. The AD8219 maintains a very high input-to-output linearity even when the differential input voltage is very small.

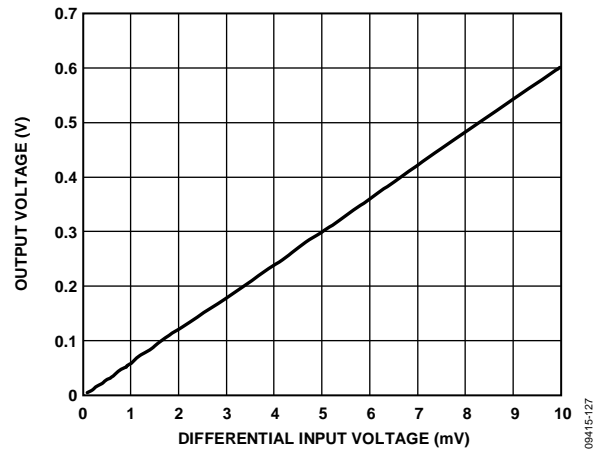

Figure 27. Typical Gain Linearity at Small Differential Inputs (V<sub>CM</sub> = 4 V to 80 V)

Regardless of the common mode, the AD8219 provides a correct output voltage when the input differential is at least 1 mV. The ability of the AD8219 to work with very small differential inputs, regardless of the common-mode voltage, allows for optimal dynamic range, accuracy, and flexibility in any current sensing application.

## APPLICATIONS INFORMATION

### HIGH-SIDE CURRENT SENSING

In this configuration, the shunt resistor is referenced to the battery (see Figure 28). High voltage is present at the inputs of the current sense amplifier. When the shunt is battery referenced, the AD8219 produces a linear ground referenced analog output.

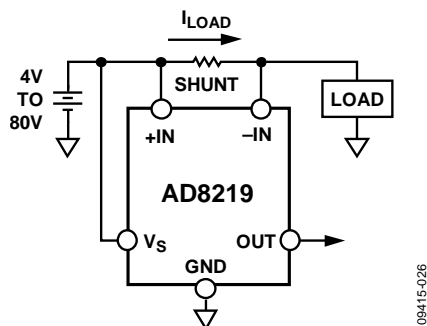

Figure 28. Battery Referenced Shunt Resistor

Figure 28 shows the supply pin,  $V_S$ , connected directly to the positive input (+IN) pin. In this mode, the internal LDO powers the AD8219 as long as the common-mode voltage at the input pins is 4 V to 80 V. Additionally,  $V_S$  can also be connected to a standalone supply that can vary from 4 V to 80 V as shown in Figure 29.

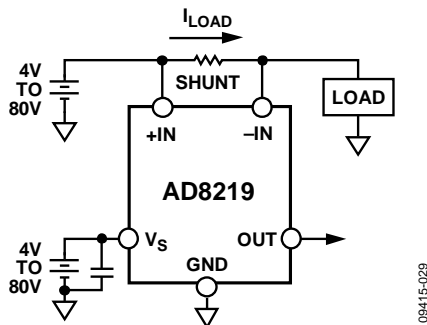

Figure 29. Standalone Supply Operation

### MOTOR CONTROL CURRENT SENSING

The AD8219 is a practical, accurate solution for high-side current sensing in motor control applications. In cases where the shunt resistor is referenced to a battery and the current flowing is unidirectional (as shown in Figure 30), the AD8219 monitors the current with no additional supply pin necessary provided the battery voltage in the following circuit is in the 4 V to 80 V range.

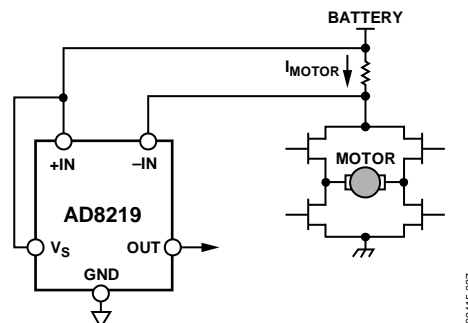
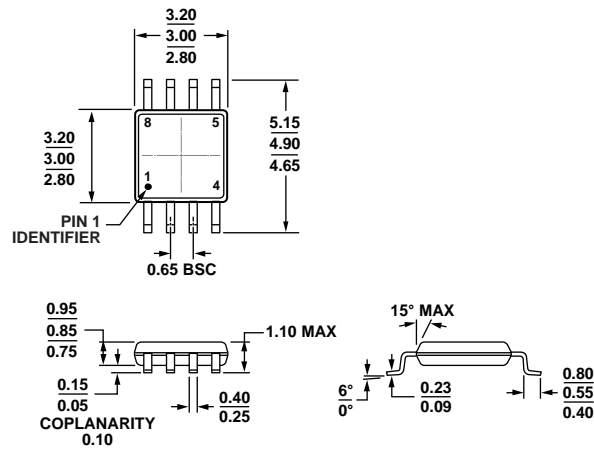

Figure 30. High-Side Current Sensing in Motor Control

OUTLINE DIMENSIONS



COMPLIANT TO JEDEC STANDARDS MO-187-AA  
 Figure 31. 8-Lead Mini Small Outline Package [MSOP]  
 (RM-8)  
 Dimensions shown in millimeters

10-07-2009-B

ORDERING GUIDE

Model <sup>1</sup>	Temperature Range	Package Description	Package Option	Branding
AD8219BRMZ	-40°C to +125°C	8-Lead Mini Small Outline Package [MSOP]	RM-8	Y3S
AD8219BRMZ-RL	-40°C to +125°C	8-Lead Mini Small Outline Package [MSOP]	RM-8	Y3S

<sup>1</sup> Z = RoHS Compliant Part.