

Introduction

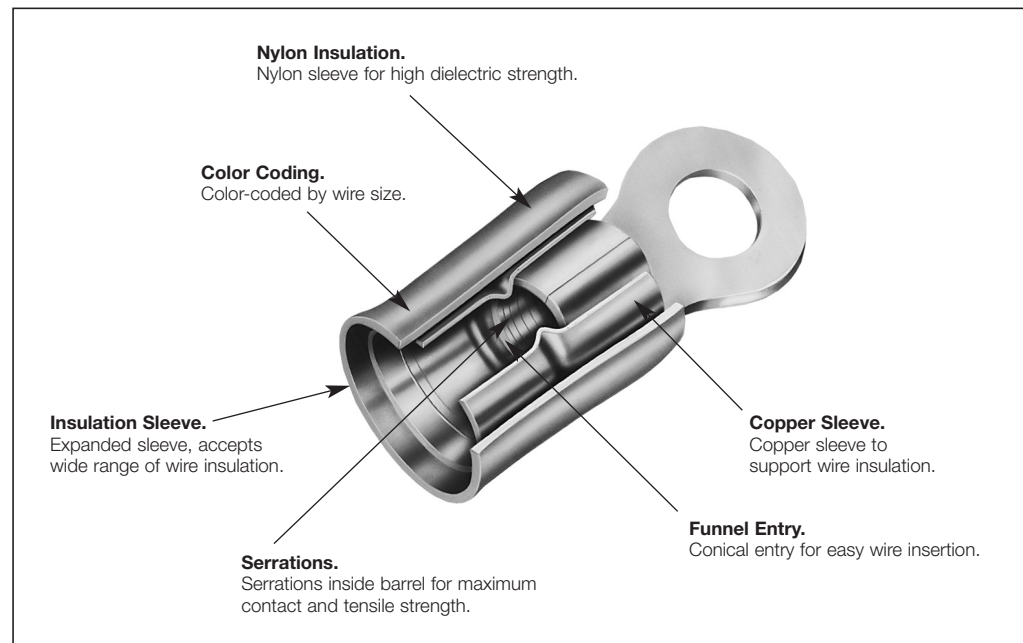

Product Facts

- Basic terminal is made of high conductivity copper, electro tin plated, for improved corrosion resistance.
- Applicable wire size is marked on the tongue.
- Inner serrations on the wire barrel gives maximum electrical contact and tensile strength with the conductor.
- Copper sleeve provides circum-ferential insulation support to the wire and allows the wire to be bent in any direction without damaging the wire insulation or conductors.
- Insulation sleeves and corresponding tooling are color-coded by wire size for easier identification.
- AMP PIDG Terminals and Splices meet the requirements of MIL-T-7928.
- A variety of PIDG terminals and splices are UL listed File E 13288 and certified by CSA File LR 7189.



PIDG pre-insulated Diamond Grip Terminals and Splices are designed for complete and uniform reliability. The pre-insulated termination ensures a vibration safe connection of maximum conductivity, and its tensile strength approaches that of the wire itself.

Each PIDG terminal consists of a tin plated copper body, with a specially designed copper sleeve and insulation sleeve fitted over the terminal barrel.

The carefully engineered application tooling has been designed for the PIDG program to ensure high quality terminations time after time. Terminal and insulation sleeve are crimped simultaneously resulting in an excellent tensile strength and vibration resistance.

During crimping dot code is applied to the insulation sleeve, to confirm the use of the correct tooling.

In order to obtain the best termination results it is important to select the correct tool.

Each terminal is matched to a compatible tool. CERTI-CRIMP hand tools are provided with a patented ratched device to ensure the crimp cycle is completed before releasing. There is a CERTI-CRIMP tool available for each terminal range.

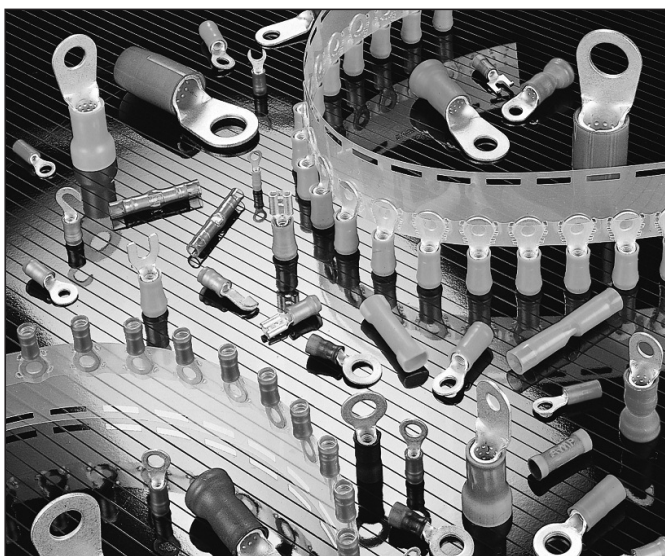

AWG Identification Numbers

The International AWG Identification Numbers

Each TE Connectivity Terminal and Splice covers specific international wire range and has the applicable wire size marked on the tongue or the barrel. Insulated terminals and splices are color coded for easy identification. All application tools have a special matching control system.

With this technique the quality of the termination made can be reliably checked at any time. During crimping the application tooling marks a proper visual code on the terminal or insulation sleeve. If the code of the terminal and the mark of the tool are corresponding, a reliable termination with the correct tooling has been made.

Cross Reference of AWG Code Numbers to Wire Size Range

AWG Code Number	Wire Size Range (mm ²)	for DIN Cross Section (mm ²)
26-22	0.10- 0.40	0.14/0.20/0.25/0.35
22-16	0.25- 1.60	0.35/0.50/0.75/1.00/1.50
16-14	1.00- 2.60	1.00/1.50/2.50
16-14 HD*	1.00- 2.60	1.00/1.50/2.50
12-10	2.70- 6.60	4.00/6.00
8	6.70- 10.50	10.0
6	10.60- 16.70	16.0
4	16.80- 26.60	25.0
2	26.70- 42.40	35.0
1/0	42.50- 60.50	50.0
2/0	60.60- 76.20	70.0
3/0	76.30- 97.00	95.0
4/0	98.00-120.00	120.0
250-300 MCM	121.00-151.00	150.0
300-350 MCM	152.00-192.00	185.0
400-350 MCM	193.00-242.00	240.0
500-600 MCM	243.00-304.00	300.0

*) Heavy-duty terminals use AWG 12-10 (2.7-6.6 mm²) tooling.

Minimum Number of Wires, Diameter of Conductor for Insulated High Current Conductors

Wire Size Range (mm ²)	Number and Diameter of Wires (mm)	Diameter of Conductor (mm)	Wire Size Range (mm ²)	Number and Diameter of Wires (mm)	Diameter of Conductor (mm)
0.14	1 x 0.42	0.42	25.0	1 x 5.64	5.64
	18 x 0.10	-		7 x 2.13	6.40
	8 x 0.15	-		84 x 0.62	7.70
0.20	1 x 0.50	0.50	35.0	200 x 0.40	7.50
	11 x 0.15	-		797 x 0.20	7.60
	26 x 0.10	-		19 x 1.53	7.70
0.25	1 x 0.60	0.60	50.0	133 x 0.58	8.70
	14 x 0.15	-		280 x 0.40	8.70
	1 x 0.67	0.67		1115 x 0.20	9.00
0.35	7 x 0.26	0.80	70.0	19 x 1.83	9.20
	12 x 0.21	0.90		133 x 0.69	10.40
	1 x 0.80	0.80		400 x 0.40	11.00
0.50	7 x 0.30	0.90	95.0	1592 x 0.20	11.00
	16 x 0.21	1.00		19 x 2.17	11.00
	1 x 1.00	1.00		189 x 0.69	12.70
0.75	24 x 0.20	1.20	120.0	560 x 0.40	12.00
	1 x 1.13	1.13		1427 x 0.25	12.50
	32 x 0.20	1.30		19 x 2.52	12.60
1.50	1 x 1.38	1.38	150.0	259 x 0.69	14.50
	7 x 0.52	1.60		485 x 0.50	14.90
	30 x 0.25	1.60		1936 x 0.25	14.90
2.50	1 x 1.78	1.78	185.0	37 x 2.03	14.20
	7 x 0.67	2.00		336 x 0.67	16.40
	50 x 0.25	2.10		614 x 0.50	16.00
4.00	1 x 2.26	2.26	240.0	2445 x 0.25	16.40
	19 x 0.52	2.60		37 x 2.26	15.80
	56 x 0.30	2.80		392 x 0.69	18.00
6.00	1 x 2.26	2.26	300.0	765 x 0.50	19.20
	19 x 0.64	3.20		2123 x 0.30	19.30
	84 x 0.30	3.50		37 x 2.52	18.00
10.00	1 x 3.57	3.57	240.0	494 x 0.69	19.00
	7 x 1.35	4.10		944 x 0.44	20.00
	49 x 0.51	4.60		2618 x 0.30	21.00
16.00	80 x 0.40	5.00	300.0	61 x 2.24	20.50
	1 x 4.52	4.52		627 x 0.69	22.00
	7 x 1.70	5.10		1225 x 0.50	23.00
	49 x 0.65	5.90		3396 x 0.30	24.00
	127 x 0.40	6.00		61 x 2.50	23.00
				790 x 0.69	25.00
				1530 x 0.50	27.00

Ring Tongue Terminals – Nylon

Material and Finish

Insulation:

Nylon acc. UL 94 V-2

Terminal Body and Metallic Sleeve:

Copper per ASTM B-152

Plating:

Tin per ASTM B-545

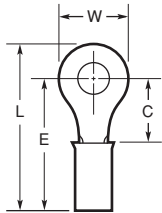

Wire Size AWG (mm ²)	Tongue Material Thickness Max.	Stud Size	Dimensions				Terminal Insulation Color	Wire Insulation Diameter Max.	Part Numbers			
			W	C Min.	E Max.	L Max.			Loose Piece	Tape Mounted		
26-24 (0.12-0.24)	.029 0.74	2 M2	.203 5.16	.211 5.36	.632 16.05	.739 18.77	Yellow	.105 2.67	54310-1*	-		
		4	.203 5.16	.211 5.36	.632 16.05	.736 18.69	Yellow	.105 2.67	52189*	-		
		8 M4	.281 7.14	.250 6.35	.671 17.04	.814 20.68	Yellow	.105 2.67	54311-1*	-		
		0	.140 3.56	.121 3.07	.452 11.48	.525 13.34	Yellow	.082 2.08	321013	-		
			.140 3.56	.121 3.07	.452 11.48	.525 13.34	Yellow	.082 2.08	-	2-323912-1		
		2 M2	.140 3.56	.211 5.36	.542 13.77	.615 15.62	Yellow	.082 2.08	329951	-		
26-22 (0.10-0.41)	.020 0.51		.203 5.16	.211 5.36	.542 13.77	.646 16.41	Yellow	.082 2.08	323913	-		
		8 M4	.250 6.35	.281 7.14	.612 15.54	.740 18.80	Yellow	.082 2.08	-	2-323916-1		
		4	.281 7.14	.250 6.35	.631 16.03	.774 19.66	White	.100 2.54	323985	-		
		6 M3.5	.281 7.14	.250 6.35	.631 16.03	.774 19.66	White	.100 2.54	323986	-		
		8 M4	.312 7.92	.281 7.14	.662 16.81	.821 20.85	White	.100 2.54	323989	-		
		10	.312 7.92	.281 7.14	.662 16.81	.821 20.85	White	.100 2.54	323990	-		
24-20 (0.16-0.65)	.025 0.64	2 M2	.182 4.62	.172 4.37	.576 14.63	.669 16.99	Red	.125 3.18	324158	-		
			.218 5.54	.156 3.96	.560 14.22	.672 17.07	Red	.125 3.18	328657	-		
			.182 4.62	.172 4.37	.576 14.63	.669 16.99	Green/Red	.125 3.18	327654	-		
			.182 4.62	.172 4.37	.576 14.63	.669 16.99	Red	.140 3.56	320882	2-320882-1		
		4	.218 5.54	.156 3.96	.560 14.22	.672 17.07	Red	.125 3.18	-	2-320553-2		
			.218 5.54	.156 3.96	.560 14.22	.672 17.07	Red	.125 3.18	36254**	-		
			.250 6.35	.312 7.92	.716 18.19	.844 21.44	Red	.140 3.56	330648	2-330648-1		
			.218 5.54	.156 3.96	.560 14.22	.672 17.07	Red	.125 3.18	-	2-36149-2		
		22-16 (0.26-1.65)	.033 0.84		.218 5.54	.156 3.96	.560 14.22	.672 17.07	Red	.140 3.56	36150	2-36150-1
				6 M3.5	.250 6.35	.250 6.35	.654 16.61	.782 19.86	Red	.125 3.18	51863	51863-1
					.312 7.92	.281 7.14	.685 17.40	.844 21.44	Red	.125 3.18	323008	-
					.312 7.92	.281 7.14	.685 17.40	.844 21.44	Red	.140 3.56	326878	-
8 M3.5	.281 7.14			.250 6.35	.654 16.61	.797 20.24	Red	.125 3.18	320554	2-320554-1		
	.281 7.14			.250 6.35	.654 16.61	.797 20.24	Red	.140 3.56	-	2-31887-1		
10			.312 7.92	.281 7.14	.685 17.40	.844 21.44	Red	.125 3.18	-	2-36153-2		
			.344 8.74	.297 7.54	.701 17.81	.876 22.25	Red	.125 3.18	32836	-		
			.344 8.74	.297 7.54	.701 17.81	.876 22.25	Red	.140 3.56	32837	32837-1		
			.344 8.74	.297 7.54	.701 17.81	.876 22.25	Red	.140 3.56	-	-		

* Must be crimped with 22-18 or 22-16 PIDG (red) Tooling.
 ** Slightly larger than standard #4 stud hole (.128 in./3.25 mm).
 Note: "C" dimension applies from edge of metal wire barrel to center of stud hole.

Ring Tongue Terminals – Nylon (continued)

Material and Finish

Insulation:

Nylon acc. UL 94 V-2

Terminal Body and Metallic Sleeve:

Copper per ASTM B-152

Plating:

Tin per ASTM B-545

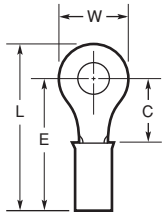

Wire Size AWG (mm ²)	Tongue Material Thickness Max.	Stud Size	Dimensions				Terminal Insulation Color	Wire Insulation Diameter Max.	Part Numbers	
			W	C Min.	E Max.	L Max.			Loose Piece	Tape Mounted
22-16 (0.26-1.65)	.033 0.84	5/16 M8	.469	.437	.841	1.078	●	.125	320572	2-320572-1
			11.91	11.10	21.36	27.38	●	3.18		
			.469	.437	.841	1.078	●	.140	31895	2-31895-1
			11.91	11.10	21.36	27.38	●	3.56		
			.531	.546	.950	1.218	●	.125	324123	-
			13.49	13.87	24.13	30.94	●	3.18		
		3/8	.531	.546	.950	1.218	●	.125	320573	2-320573-4
			13.49	13.87	24.13	30.94	●	3.18		
			.531	.546	.950	1.218	●	.140	31897	2-31897-2
			13.49	13.87	24.13	30.94	●	3.56		
			.713	.530	.934	1.293	●	.125	328975	-
			18.11	13.46	23.72	32.84	●	3.18		
16-14 (1.04-2.62)	.033 0.84	4	.250	.171	.575	.703	●	.150	324159	2-324159-2
			6.35	4.34	14.61	17.86	●	3.81		
			.250	.171	.575	.703	●	.170	-	2-328996-1
			6.35	4.34	14.61	17.86	●	4.32		
			.250	.281	.685	.813	●	.150	323676	-
			6.35	7.14	17.40	20.65	●	3.81		
		6 M3.5	.250	.171	.575	.703	●	.150	-	2-320561-2
			6.35	4.34	14.61	17.86	●	3.81		
			.250	.281	.685	.813	●	.170	50881	50881-2
			6.35	7.14	17.40	20.65	●	4.32		
			.312	.250	.654	.813	●	.170	326882	2-326882-1
			7.92	6.35	16.61	20.65	●	4.32		
8 M4	.343	.281	.685	.859	●	.150	36157	-		
	8.71	7.14	17.40	21.82	●	3.81				
	.312	.250	.654	.813	●	.170	-	53941-2		
	7.92	6.35	16.61	20.65	●	4.32				
	.343	.281	.685	.859	●	.150	320560	2-320560-1		
	8.71	7.14	17.40	21.82	●	3.81				
10	.312	.250	.654	.813	●	.170	53942-1	53942-2		
	7.92	6.35	16.61	20.65	●	4.32				
	.343	.281	.685	.859	●	.150	320574	2-320574-2		
	8.71	7.14	17.40	21.82	●	3.81				
	.469	.437	.841	1.078	●	.170	324533	-		
	11.91	11.10	21.36	27.38	●	4.32				
5/16 M8	.469	.437	.841	1.078	●	.150	320575	2-320575-1		
	11.91	11.10	21.36	27.38	●	3.81				
	.469	.437	.841	1.078	●	.170	328998	2-328998-1		
	11.91	11.10	21.36	27.38	●	4.32				
	.531	.546	.950	1.218	●	.150	320564	-		
	13.49	13.87	24.13	30.94	●	3.81				
3/8	.531	.546	.950	1.218	●	.170	-	2-328999-1		
	13.49	13.87	24.13	30.94	●	4.32				
	.713	.530	.934	1.293	●	.170	328849	-		
	18.11	13.46	23.72	32.84	●	4.32				
	.281	.219	.810	.953	●	.230	320631	-		
	7.14	5.56	20.57	24.21	●	5.84				
16-14HD* (1.04-2.62)	.050 1.27	6 M3.5	.281	.219	.810	.953	●	.250	35634	-
			7.14	5.56	20.57	24.21	●	6.35		
		8 M4	.343	.281	.872	1.046	●	.230	320627	-
			8.71	7.14	22.15	26.57	●	5.84		
		10	.343	.281	.872	1.046	●	.250	35106	2-35106-1
			8.71	7.14	22.15	26.57	●	6.35		
10	.343	.281	.872	1.046	●	.230	320630	2-320630-2		
	8.71	7.14	22.15	26.57	●	5.84				

* Heavy duty for extra mechanical strength.

Note: "C" dimension applies from edge of metal wire barrel to center of stud hole.

Ring Tongue Terminals – Nylon (continued)

Material and Finish

Insulation:

Nylon acc. UL 94 V-2

Terminal Body and Metallic Sleeve:

Copper per ASTM B-152

Plating:

Tin per ASTM B-545

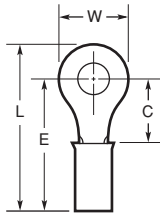

Wire Size AWG (mm ²)	Tongue Material Thickness Max.	Stud Size	Dimensions				Terminal Insulation Color	Wire Insulation Diameter Max.	Part Numbers	
			W	C Min.	E Max.	L Max.			Loose Piece	Tape Mounted
16-14HD* (1.04-2.62)	.050 1.27	1/4 M6	.500	.344	.935	1.188	Yellow/Black	.230	34974	2-34974-1
			12.70	8.74	23.75	30.18		5.84		
		5/16 M8	.500	.344	.935	1.188	Yellow/Black	.250	323682	2-323682-1
			12.70	8.74	23.75	30.18		6.35		
		3/8	.531	.437	1.028	1.296	Yellow/Black	.250	34806	-
			13.49	11.10	26.11	32.92		6.35		
		1/2 M12	.531	.437	1.028	1.296	Yellow/Black	.250	34810	-
			13.49	11.10	26.11	32.92		6.35		
		3/4	.750	.625	1.216	1.594	Yellow/Black	.250	35316	-
			19.05	15.88	30.89	40.49		6.35		
		4	1.250	1.000	1.591	2.219	Yellow/Black	.250	36203	-
			31.75	25.40	40.41	56.36		6.35		
6	1.250	1.000	1.591	2.219	Yellow/Black	.250	322724	-		
	31.75	25.40	40.41	56.36		6.35				
M3.5	.281	.219	.810	.953	Yellow	.250	35148	-		
	7.14	5.56	20.57	24.21		6.35				
8	.281	.219	.810	.953	Yellow	.230	320634	2-320634-1		
	7.14	5.56	20.57	24.21		5.84				
M4	.281	.219	.810	.953	Yellow	.250	35149	-		
	7.14	5.56	20.57	24.21		6.35				
10	.312	.302	.893	1.052	Yellow	.230	326886	-		
	7.92	7.67	22.68	26.72		5.84				
1/4 M6	.375	.302	.893	1.083	Yellow	.250	-	2-35107-1		
	9.53	7.67	22.68	27.51		6.35				
5/16 M8	.312	.281	.872	1.031	Yellow	.230	35787	1-35787-0		
	7.92	7.14	22.15	26.19		5.84				
3/8	.312	.302	.893	1.052	Yellow	.230	324915	-		
	7.92	7.67	22.68	26.72		5.84				
1/2 M12	.312	.302	.893	1.052	Yellow	.230	324918	1-324918-0		
	7.92	7.67	22.68	26.72		5.84				
12-10 (2.62-6.64)	.042 1.07	10	.343	.281	.872	1.046	Yellow	.230	-	1-32883-0
			8.71	7.14	22.15	26.57		5.84		
1/4 M6	.375	.302	.893	1.083	Yellow	.230	36161	-		
									9.53	7.67
5/16 M8	.500	.344	1.179	1.432	Yellow	.220	329389	-		
									12.70	8.74
3/8	.500	.344	.935	1.188	Yellow	.230	35273	-		
									12.70	8.74
1/2 M12	.531	.468	1.054	1.322	Yellow	.230	320569	-		
									13.49	11.89
5/16 M8	.531	.468	1.054	1.322	Yellow	.250	35111	-		
									13.49	11.89
3/8	.593	.531	1.115	1.414	Yellow	.230	320577	2-320577-3		
									15.06	13.49
1/2 M12	.593	.531	1.115	1.414	Yellow	.250	35112	-		
									15.06	13.49
1/2 M12	.750	.625	1.216	1.594	Yellow	.250	35151	-		
									19.05	15.88

* Heavy duty for extra mechanical strength.

Note: "C" dimension applies from edge of metal wire barrel to center of stud hole.

Ring Tongue Terminals – Vinyl

Material and Finish

Insulation:

Vinyl acc. UL 94 V-0

Terminal Body and Metallic Sleeve:

Copper per ASTM B-152

Plating:

Tin per ASTM B-545

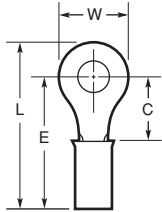

Wire Size AWG (mm ²)	Tongue Material Thickness Max.	Stud Size	Dimensions				Terminal Insulation Color	Wire Insulation Diameter Max.	Part Numbers			
			W	C Min.	E Max.	L Max.			Loose Piece	Tape Mounted		
16-14HD* (1.04-2.62)	.050 1.27	10	.343 8.71	.281 7.14	.961 24.41	1.135 28.83		.300 7.62	35363	-		
		6 M3.5	.375 9.53	.302 7.67	.982 24.94	1.172 29.77		.300 7.62	35604	-		
		8 M4	.375 9.53	.302 7.67	.982 24.94	1.172 29.77		.300 7.62	35605	2-35605-2		
	12-10 (2.62-6.64)	.042 1.07	10	.375 9.53	.302 7.67	.982 24.94	1.172 29.77		.300 7.62	35364	-	
			1/4 M6	.500 12.70	.344 8.74	1.024 26.01	1.277 32.44		.300 7.62	323763	-	
			5/16 M8	.531 13.49	.468 11.89	1.148 29.16	1.416 35.97		.300 7.62	35345	2-35345-1	
			3/8	5/16 M8	.531 13.49	.468 11.89	1.148 29.16	1.416 35.97		.300 7.62	35346	2-35346-1
				3/8	.593 15.06	.531 13.49	1.211 30.76	1.510 38.35		.300 7.62	35478	1-35478-0

* Heavy duty for extra mechanical strength.

Note: "C" dimension applies from edge of metal wire barrel to centre of stud hole.

Ring Tongue Terminals – Insulation Restricting

Material and Finish

Insulation:

Nylon acc. UL 94 V-2

Terminal Body:

Copper per ASTM B-152

Plating:

Tin per ASTM B-545

Metallic Sleeve:

Copper per ASTM B-152

Plating:

Nickel per QQ-N-290 or

Tin per ASTM B-545

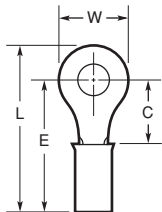

Wire Size AWG (mm ²)	Tongue Material Thickness Max.	Stud Size	Dimensions				Terminal Insulation Color Solid/Stripe	Wire Insulation Diameter Range	Part Numbers			
			W	C Min.	E Max.	L Max.			Loose Piece	Tape Mounted		
24 (0.24)	.020 0.51	4	.203 5.16	.211 5.36	.587 14.91	.691 17.55		.031-.055 0.79-1.40	2-323914-2	-		
			.218 5.54	.156 3.96	.622 15.80	.734 18.64		.038-.110 0.97-2.79	52273	-		
		6 M3.5	.218 5.54	.156 3.96	.622 15.80	.734 18.64		.038-.110 0.97-2.79	2-36149-3	-		
			.250 6.35	.250 6.35	.716 18.19	.844 21.44		.038-.110 0.97-2.79	51863-2	-		
		22 (0.38)	.033 0.84	8 M4	.312 7.92	.281 7.14	.747 18.97	.906 23.01		.038-.110 0.97-2.79	1-320551-2	-
				10	.312 7.92	.281 7.14	.747 18.97	.906 23.01		.038-.110 0.97-2.79	2-36153-3	-

Note: "C" dimension applies from edge of metal wire barrel to centre of stud hole.

Ring Tongue Terminals – Insulation Restricting (continued)

Material and Finish

Insulation:

Nylon acc. UL 94 V-2

Terminal Body:

Copper per ASTM B-152

Plating:

Tin per ASTM B-545

Metallic Sleeve:

Copper per ASTM B-152

Plating:

Nickel per QQ-N-290 or

Tin per ASTM B-545

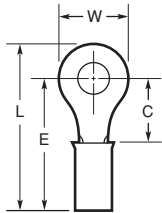

Wire Size AWG (mm ²)	Tongue Material Thickness Max.	Stud Size	Dimensions				Terminal Insulation Color Solid/Stripe	Wire Insulation Diameter Range	Part Numbers	
			W	C Min.	E Max.	L Max.			Loose Piece	Tape Mounted
20 (0.60)	.033 0.84	4	.218 5.54	.156 3.96	.622 15.80	.734 18.64		.046-.110 1.17-2.79	52273-1	–
		6 M3.5	.218 5.54	.156 3.96	.622 15.80	.734 18.64		.046-.110 1.17-2.79	2-36149-4	–
			.250 6.35	.250 6.35	.716 18.19	.844 21.44		.046-.110 1.17-2.79	51863-3	–
		8 M4	.312 7.92	.281 7.14	.747 18.97	.906 23.01		.046-.110 1.17-2.79	1-320551-3	–
		10	.312 7.92	.281 7.14	.747 18.97	.906 23.01		.046-.110 1.17-2.79	2-36153-4	–
		1/4 M6	.469 11.91	.437 11.10	.903 22.94	1.140 28.96		.046-.110 1.17-2.79	2-320571-4	–
		5/16 M8	.469 11.91	.437 11.10	.903 22.94	1.140 28.96		.046-.110 1.17-2.79	2-320572-3	–
		4	.218 5.54	.156 3.96	.622 15.80	.734 18.64		.056-.110 1.42-2.79	52273-2	–
		6 M3.5	.218 5.54	.156 3.96	.622 15.80	.734 18.64		.056-.110 1.42-2.79	2-36149-5	–
			.250 6.35	.250 6.35	.716 18.19	.844 21.44		.056-.110 1.42-2.79	51863-4	–
.312 7.92	.281 7.14		.747 18.97	.906 23.01		.056-.110 1.42-2.79	2-36153-5	–		
16 (1.42)	.033 0.84	4	.250 6.35	.171 4.34	.637 16.18	.765 19.43		.063-.130 1.60-3.30	52274	–
		6 M3.5	.250 6.35	.171 4.34	.637 16.18	.765 19.43		.063-.130 1.60-3.30	2-320561-3	–
			.312 7.92	.281 7.14	.747 18.97	.906 23.01		.063-.130 1.60-3.30	1-51864-0	–
		10	.312 7.92	.281 7.14	.747 18.97	.906 23.01		.063-.130 1.60-3.30	51864-7	–
		1/4 M6	.469 11.91	.437 11.10	.903 22.94	1.140 28.96		.063-.130 1.60-3.30	2-320563-3	–
		3/8	.531 13.49	.546 13.87	1.012 25.70	1.280 32.51		.063-.130 1.60-3.30	2-320564-1	–
14 (2.15)	.033 0.84	6 M3.5	.250 6.35	.171 4.34	.637 16.18	.765 19.43		.078-.130 1.98-3.30	2-320561-4	–
			.312 7.92	.281 7.14	.747 18.97	.906 23.01		.078-.130 1.98-3.30	51864-8	–
		8 M4	.312 7.92	.281 7.14	.747 18.97	.906 23.01		.078-.130 1.98-3.30	1-51864-1	–
		10	.312 7.92	.281 7.14	.747 18.97	.906 23.01		.078-.130 1.98-3.30	51864-9	–
12 (3.37)	.042 1.07	6 M3.5	.375 9.53	.302 7.67	.958 24.33	1.148 29.16		.095-.200 2.41-5.08	2-36161-5	–
			.375 9.53	.302 7.67	.958 24.33	1.148 29.16		.095-.200 2.41-5.08	2-320568-2	–
		10	.375 9.53	.302 7.67	.958 24.33	1.148 29.16		.095-.200 2.41-5.08	2-36161-3	–
		1/4 M6	.531 13.49	.468 11.89	1.124 28.55	1.392 35.36		.095-.200 2.41-5.08	2-320569-5	–
10 (6.11)	.042 1.07	6 M3.5	.375 9.53	.302 7.67	.958 24.33	1.148 29.16		.119-.200 3.02-5.08	2-36161-6	–
			.375 9.53	.302 7.67	.958 24.33	1.148 29.16		.119-.200 3.02-5.08	2-320568-3	–
		10	.375 9.53	.302 7.67	.958 24.33	1.148 29.16		.119-.200 3.02-5.08	2-36161-4	–
		1/4 M6	.531 13.49	.468 11.89	1.124 28.55	1.392 35.36		.119-.200 3.02-5.08	2-320569-6	–
		5/16 M8	.531 13.49	.468 11.89	1.124 28.55	1.392 35.36		.119-.200 3.02-5.08	2-320576-3	–

Note: “C” dimension applies from edge of metal wire barrel to center of stud hole.

Rectangular Tongue Terminals

Material and Finish

Insulation:

Nylon acc. UL 94 V-2

Terminal Body and Metallic Sleeve:

Copper per ASTM B-152
except where noted

Plating:

Tin per ASTM B-545

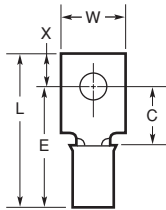

Wire Size AWG (mm ²)	Tongue Material Thickness Max.	Stud Size	Dimensions					Terminal Insulation Color	Wire Insulation Diameter Max.	Part Numbers	
			W	C Min.	E Max.	L Max.	X			Loose Piece	Tape Mounted
22-16 (0.26-1.65)	.033 0.84	4	.237 6.02	.404 10.26	.810 20.57	1.015 25.78	.195 4.95	●	.140 3.56	327962	—
		6 M3.5	.237 6.02	.404 10.26	.810 20.57	1.015 25.78	.195 4.95	●	.140 3.56	2-327956-1	—
16-14 (1.04-2.62)	.033 0.84	6 M3.5	.244 6.20	.312 7.92	.716 18.19	.856 21.74	.125 3.18	●	.170 4.32	33173	—
		8 M4	.302 7.67	.465 11.81	.872 22.15	1.109 28.17	.227 5.77	●	.150 3.81	2-327946-4	—
12-10 (2.62-6.64)	.042 1.07	5 M3	.277 7.04	.277 7.04	.889 22.58	1.042 26.47	.143 3.63	●	.230 5.84	327954	—
		6 M3.5	.237 6.02	.404 10.26	.998 25.35	1.203 30.56	.195 4.95	●	.230 5.84	2-327960-1	—

Note: "C" dimension applies from edge of metal wire barrel to center of stud hole.

Spade Tongue Terminals

Material and Finish

Insulation:

Nylon acc. UL 94 V-2

Terminal Body and Metallic Sleeve:

Copper per ASTM B-152
except where noted

Plating:

Tin per ASTM B-545

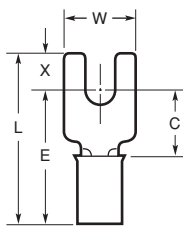

Wire Size AWG (mm ²)	Tongue Material Thickness Max.	Stud Size	Dimensions					Terminal Insulation Color	Wire Insulation Diameter Max.	Part Numbers	
			W	C Min.	E Max.	L Max.	X			Loose Piece	Tape Mounted
26-24 (0.12-0.24)	.029 0.74	6 M3.5	.250 6.35	.211 5.36	.632 16.05	.709 18.01	.072 1.83	●	.095 2.41	—	53115-2
26-22 (0.10-0.41)	.020 0.51	4	.203 5.16	.211 5.36	.542 13.77	.627 15.93	.076 1.93	●	.082 2.08	321035	2-321035-1
		2 M2	.182 4.62	.203 5.16	.607 15.42	.727 18.47	.115 2.92	●	.140 3.56	—	2-328394-1
22-16 (0.26-1.65)	.033 0.84	4	.218 5.54	.156 3.96	.560 14.22	.674 17.12	.109 2.77	●	.125 3.18	1-327717-0	—
			.218 5.54	.156 3.96	.560 14.22	.674 17.12	.109 2.77	●	.140 3.56	327717	—
		6 M3.5	.297 7.54	.203 5.16	.607 15.42	.753 19.13	.141 3.58	●	.125 3.18	34080	2-34080-1
			.297 7.54	.203 5.16	.607 15.42	.753 19.13	.141 3.58	●	.140 3.56	—	2-326861-1
		8 M4	.375 9.53	.312 7.92	.716 18.19	.908 23.06	.187 4.75	●	.125 3.18	32050	—
			.375 9.53	.312 7.92	.716 18.19	.908 23.06	.187 4.75	●	.125 3.18	32051	2-32051-1
16-14 (1.04-2.62)	.033 0.84	10	.375 9.53	.312 7.92	.716 18.19	.908 23.06	.187 4.75	●	.140 3.56	32054	2-32054-1
			6 M3.5	.297 7.54	.203 5.16	.607 15.42	.753 19.13	.141 3.58	●	.170 4.32	—
12-10 (2.62-6.64)	.042 1.07	8 M4	.312 7.92	.296 7.52	.887 22.53	1.095 27.81	.203 5.16	●	.230 5.84	—	2-326859-1
			.406 10.31	.296 7.52	.887 22.53	1.095 27.81	.203 5.16	●	.230 5.84	—	2-32588-1
10	.042 1.07	10	.406 10.31	.296 7.52	.887 22.53	1.095 27.81	.203 5.16	●	.250 6.35	35152	—
			.406 10.31	.296 7.52	.887 22.53	1.095 27.81	.203 5.16	●	.230 5.84	—	2-32589-1

Note: "C" dimension applies from edge of metal wire barrel to center of stud hole.

Flanged Spade Tongue Terminals

Material and Finish

Insulation:

Nylon acc. UL 94 V-2

Terminal Body and Metallic Sleeve:

Copper per ASTM B-152

Plating:

Tin per ASTM B-545

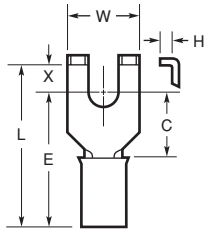

Wire Size AWG (mm ²)	Tongue Material Thickness Max.	Stud Size	Dimensions						Terminal Insu- lation Color	Wire Insulation Diameter Max.	Part Numbers	
			W	C Min.	E Max.	L Max.	X Min.	H Min.			Loose Piece	Tape Mounted
26-22 (0.10-0.41)	.020 0.51	2	.182	.203	.534	.649	.110	.026	Yellow	.082 2.08	324597	-
		M2	4.62	5.16	13.56	16.48	2.79	0.66				
		4	.193	.203	.534	.649	.110	.026	Yellow	.082 2.08	52369	-
		6	.250	.203	.534	.649	.110	.026	Yellow	.082 2.08	-	51874-1
22-16 (0.26-1.65)	.033 0.84	2	.182	.203	.607	.727	.115	.041	Red	.125 3.18	2-324608-2	-
		6	.182	.203	.607	.727	.115	.041	Red	.140 3.56	324608	-
		6	.250	.203	.607	.737	.125	.046	Red	.125 3.18	322777	2-322777-1
		6	.296	.203	.607	.737	.125	.046	Red	.125 3.18	-	2-32561-1
		8	.296	.203	.607	.737	.125	.046	Red	.140 3.56	-	2-32562-1
		8	.416	.250	.654	.830	.171	.062	Red	.125 3.18	32497	-
8	.416	.250	.654	.830	.171	.062	Red	.140 3.56	32498	2-32498-1		
											M4	10.57
16-14 (1.04-2.62)	.033 0.84	6	.294	.203	.607	.737	.125	.047	Blue	.150 3.81	2-320861-2	-
		6	.294	.203	.607	.737	.125	.047	Blue	.170 4.32	-	2-320861-1
		8	.294	.203	.607	.737	.125	.047	Blue	.170 4.32	-	2-320862-1
8	.416	.250	.654	.830	.171	.062	Blue	.150 3.81	33155	-		
											M4	10.57
10	.416	.250	.654	.830	.171	.062	Blue	.170 4.32	33156	-		
											M4	10.57
10	.294	.203	.607	.737	.125	.052	Blue	.170 4.32	320863	2-320863-2		
											M4	7.47
12-10 (2.62-6.64)	.042 1.07	6	.328	.250	.841	1.017	.171	.052	Yellow	.230 5.84	324587	-
		8	.416	.250	.841	1.017	.171	.052	Yellow	.230 5.84	32510	2-32510-1
		10	.416	.250	.841	1.017	.171	.052	Yellow	.250 6.35	324015	2-324015-1

Note: "C" dimension applies from edge of metal wire barrel to center of stud hole.

Short Spring Spade Tongue Terminals

Material and Finish

Insulation:

Nylon acc. UL 94 V-2

Terminal Body:

Phosphor Bronze per ASTM B-139

Metallic Sleeve:

Copper per ASTM B-152

Plating:

Tin per ASTM B-545

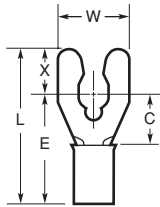

Wire Size AWG (mm ²)	Tongue Material Thickness Max.	Stud Size	Dimensions					Terminal Insu- lation Color	Wire Insulation Diameter Max.	Part Numbers	
			W	C Min.	E Max.	L Max.	X			Loose Piece	Tape Mounted
26-22 (0.10-0.41)	.020 0.51	4	.203 5.16	.219 5.56	.550 13.97	.695 17.65	.140 3.56	Yellow	.082 2.08	52922	52922-1
		8 M4	.375 9.53	.281 7.14	.612 15.54	.787 19.99	.170 4.32	Yellow	.082 2.08	52925	52925-1
22-16 (0.26-1.65)	.033 0.84	4	.203 5.16	.250 6.35	.654 16.61	.799 20.29	.140 3.56	Red	.125 3.18	52927	52927-1
		5 M3	.250 6.35	.250 6.35	.654 16.61	.799 20.29	.140 3.56	Red	.125 3.18	52928	52928-1
		6 M3.5	.250 6.35	.250 6.35	.654 16.61	.799 20.29	.140 3.56	Red	.125 3.18	52929	-
		8 M4	.244 6.20	.281 7.14	.725 18.42	.895 22.73	.170 4.32	Red	.140 3.56	-	55768-1
		8 M4	.375 9.53	.281 7.14	.685 17.40	.860 21.84	.170 4.32	Red	.125 3.18	52930	52930-1
		8 M4	.375 9.53	.281 7.14	.685 17.40	.860 21.84	.170 4.32	Red	.140 3.56	-	52930-3
16-14 (1.04-2.62)	.033 0.84	10	.406 10.31	.281 7.14	.685 17.40	.908 23.06	.218 5.54	Red	.125 3.18	52931	-
		5 M3	.250 6.35	.250 6.35	.654 16.61	.799 20.29	.140 3.56	Blue	.170 4.32	52934	52934-1
		6 M3.5	.250 6.35	.250 6.35	.654 16.61	.799 20.29	.140 3.56	Blue	.170 4.32	52935	52935-1
		6 M3.5	.250 6.35	.250 6.35	.654 16.61	.799 20.29	.140 3.56	Blue	.182 4.62	52935-2	52935-3
		8 M4	.375 9.53	.281 7.14	.685 17.40	.860 21.84	.170 4.32	Blue	.170 4.32	-	52936-1
		8 M4	.375 9.53	.281 7.14	.685 17.40	.860 21.84	.170 4.32	Blue	.182 4.62	-	52936-3
12-10 (2.62-6.64)	.042 1.07	10	.406 10.31	.281 7.14	.685 17.40	.908 23.06	.218 5.54	Blue	.170 4.32	52937	52937-1
		10	.406 10.31	.281 7.14	.685 17.40	.908 23.06	.218 5.54	Blue	.182 4.62	52937-2	52937-3
		1/4 M6	.625 15.88	.343 8.71	.747 18.97	1.033 26.24	.281 7.14	Blue	.170 4.32	52939	-
		8 M4	.375 9.53	.276 7.01	.877 22.28	1.052 26.72	.170 4.32	Yellow	.250 6.35	52942	-
1/4 M6	.625 15.88	.338 8.59	.939 23.85	1.225 31.12	.281 7.14	Yellow	.250 6.35	52945	-		

Note: "C" dimension applies from edge of metal wire barrel to center of stud hole.

Long Spring Spade Tongue Terminals

Material and Finish

Insulation:

Nylon acc. UL 94 V-2

Terminal Body:

Phosphor Bronze per ASTM B-139

Metallic Sleeve:

Copper per ASTM B-152

Plating:

Tin per ASTM B-545

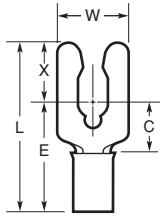

Wire Size AWG (mm ²)	Tongue Material Thickness Max.	Stud Size	Dimensions					Terminal Insulation Color	Wire Insulation Diameter Max.	Part Numbers	
			W	C Min.	E Max.	L Max.	X			Loose Piece	Tape Mounted
22-16 (0.26-1.65)	.033 0.84	6 M3.5	.250 6.35	.238 6.05	.652 16.56	.933 23.70	.276 7.01	Red	.125 3.18	52409	52409-1
		8 M4	.281 7.14	.270 6.86	.684 17.37	.979 24.87	.290 7.37	Red	.125 3.18	-	52410-1
		10	.343 8.71	.283 7.19	.697 17.70	1.005 25.53	.303 7.70	Red	.125 3.18	-	52411-1
16-14 (1.04-2.62)	.033 0.84	6 M3.5	.250 6.35	.238 6.05	.652 16.56	.933 23.70	.276 7.01	Blue	.150 3.81	52420	-
		8 M4	.281 7.14	.270 6.86	.684 17.37	.979 24.87	.290 7.37	Blue	.170 4.32	52420-1	52420-3
		10	.343 8.71	.283 7.19	.697 17.70	1.005 25.53	.303 7.70	Blue	.170 4.32	52422-1	-
		1/4 M6	.437 11.10	.345 8.76	.759 19.28	1.102 27.99	.338 8.59	Blue	.150 3.81	52423	-
		8 M4	.375 9.53	.273 6.93	.874 22.20	1.174 29.82	.295 7.49	Yellow	.250 6.35	52431-1	-
12-10 (2.62-6.64)	.042 1.07	10	.375 9.53	.305 7.75	.906 23.01	1.219 30.96	.308 7.82	Yellow	.250 6.35	52432-1	-
		1/4 M6	.437 11.10	.345 8.76	.946 24.03	1.289 32.74	.338 8.59	Yellow	.250 6.35	52433-1	-

Note: "C" dimension applies from edge of metal wire barrel to center of stud hole.

Slotted Ring Tongue Terminals

Material and Finish

Insulation:

Nylon acc. UL 94 V-2

Terminal Body and Metallic Sleeve:

Copper per ASTM B-152

Plating:

Tin per ASTM B-545

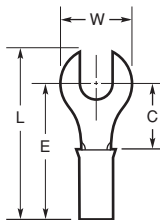

Wire Size AWG (mm ²)	Tongue Material Thickness Max.	Stud Size	Dimensions				Terminal Insulation Color	Wire Insulation Diameter Max.	Part Numbers	
			W	C Min.	E Max.	L Max.			Loose Piece	Tape Mounted
26-22 (0.10-0.41)	.020 0.51	6 M3.5	.250 6.35	.281 7.14	.612 15.54	.719 18.26	Yellow	.082 2.08	323011	2-323011-2
22-16 (0.26-1.65)	.033 0.84	8 M4	.281 7.14	.250 6.35	.654 16.61	.770 19.56	Red	.140 3.56	36954	-

Note: "C" dimension applies from edge of metal wire barrel to center of stud hole.

Hook Tongue Terminals

Material and Finish

Insulation:

Nylon acc. UL 94 V-2

Terminal Body and Metallic Sleeve:

Copper per ASTM B-152

Plating:

Tin per ASTM B-545

Wire Size AWG (mm ²)	Tongue Material Thickness Max.	Stud Size	Dimensions				Terminal Insulation Color	Wire Insulation Diameter Max.	Part Numbers	
			W	C Min.	E Max.	L Max.			Loose Piece	Tape Mounted
16-14 (1.04-2.62)	.033 0.84	8 M4	.343 8.71	.281 7.14	.685 17.40	.859 21.82		.170 4.32	320306	2-320306-1

Note: "C" dimension applies from edge of metal wire barrel to center of stud hole.

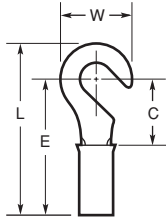

Offset Ring Tongue Terminal

Material and Finish

Insulation:

Nylon acc. UL 94 V-2

Terminal Body and Metallic Sleeve:

Copper per ASTM B-152

Plating:

Tin per ASTM B-545

Wire Size AWG (mm ²)	Tongue Material Thickness Max.	Stud Size	Dimensions				Terminal Insulation Color	Wire Insulation Diameter Max.	Part Numbers	
			W	C Min.	E Max.	L Max.			Loose Piece	Tape Mounted
22-16 (0.26-1.65)	.033 0.84	6 M3.5	.375 9.53	.312 7.92	.716 18.19	.906 23.01		.125 3.18	323039	-

Note: "C" dimension applies from edge of metal wire barrel to center of stud hole.

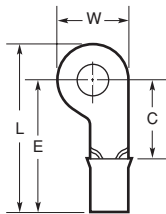

SHUR-PLUG Terminal 3.96 mm Ø (.156)

Material and Finish

Insulation:

Nylon acc. UL 94 V-2

Terminal Body and Metallic Sleeve:

Copper per ASTM B-152

Plating:

Tin per ASTM B-545

Wire Size AWG (mm ²)	Dimensions L Max.	Terminal Insulation Color	Wire Insulation Diameter Max.	Part Numbers	
				Loose Piece	Tape Mounted
16-14 (1.04-2.62)	.790 20.07		.170 4.32	324225	2-324225-1

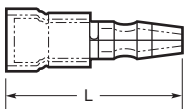

Tab

Material and Finish

Insulation:

Nylon acc. UL 94 V-2

Terminal Body and Metallic Sleeve:

Copper per ASTM B-152

Plating:

Tin per ASTM B-545

Wire Size AWG (mm ²)	Tongue Material Thickness Max.	Dimensions				Terminal Insulation Color	Wire Insulation Diameter Max.	Part Numbers	
		W	C Min.	L Max.	D			Loose Piece	Tape Mounted
22-16 (0.26-1.65)	.033 0.84	.140 3.56	.480 12.19	.904 22.96	-	●	.140 3.56	34294	-

Note: "C" dimension applies from edge of metal wire barrel to end of tab.

Knife Disconnect Splices

Material and Finish

Insulation:

Nylon acc. UL 94 V-2

Terminal Body and Metallic Sleeve:

Copper per ASTM B-152

Plating:

Tin per ASTM B-545

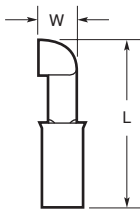

Wire Size AWG (mm ²)	Material Thickness	Dimensions		Splice Insulation Color	Wire Insulation Diameter Max.	Part Numbers	
		W	L Max.			Loose Piece	Tape Mounted
22-16 (0.26-1.65)	.031 0.79	.203 5.16	.878 22.30	●	.125 3.18	320555	-
		.203 5.16	.878 22.30	●	.140 3.56	32446	2-32446-1
16-14 (1.04-2.62)	.031 0.79	.203 5.16	.878 22.30	●	.150 3.81	320566	-
		.203 5.16	.878 22.30	●	.170 4.32	32448	-
12-10 (2.62-6.64)	.040 1.02	.281 7.14	1.234 31.34	●	.230 5.84	320620	-
		.281 7.14	1.260 32.00	●	.250 6.35	35762	-

Butt Splices

Material and Finish

Insulation:

Nylon acc. UL 94 V-2

Terminal Body and Metallic Sleeve:

Copper per ASTM B-152

Plating:

Tin per ASTM B-545

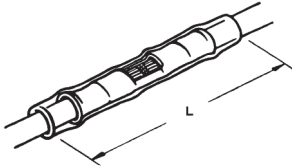

Wire Size AWG (mm ²)	Dimension L Max.	Splice Insulation Color	Wire Insulation Diameter Max.	Part Numbers	
				Loose- Piece	Tape Mounted
26-24* (0.12-0.24)	.890 22.61	Yellow	.082 2.08	323994	2-323994-1
26-22 (0.10-0.41)	.890 22.61	Yellow	.082 2.08	2-323994-2	-
22-16 (0.26-1.65)	1.265 32.13	Red	.125 3.18	320559	-
16-14 (1.04-2.62)	1.265 32.13	Blue	.150 3.81	320562	2-320562-3
12-10 (2.62-6.64)	1.656 42.06	Yellow	.220 5.59	320570	-

*) 26-24 range in accordance with MIL-T-7928.

Insulated Wire Pins

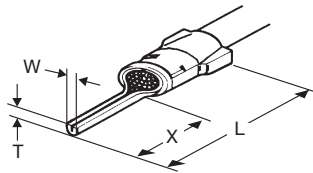

Wire Size AWG (mm ²)	Dimensions				Splice Insulation Color	Insulation Diameter Max.	Part Number
	X	W	T	L			
.005-.016 (0.14-0.4)	.264 6.7	.043 1.1	.043 1.1	.717 18.2	Yellow	.083 2.1	165514-1
.010-.063 (0.25-1.6)	.264 6.7	.071 1.8	.071 1.8	.776 19.7	Red	.142 3.6	165142
.010-.063 (0.25-1.6)	.390 9.9	.075 1.9	.071 1.8	.902 22.9	Red	.142 3.6	165168
.039-.102 (1.0-2.6)	.264 6.7	.071 1.8	.071 1.8	.799 20.3	Blue	.169 4.3	165046
.039-.102 (1.0-2.6)	.390 9.9	.071 1.8	.071 1.8	.929 23.6	Blue	.169 4.3	165172
.039-.102 (1.0-2.6)	.598 15.2	.106 2.7	.091 2.3	1.146 29.1	Blue	.169 4.3	9-160402-2
.106-.260 (2.7-6.6)	.390 9.9	.102 2.6	.102 2.6	1.122 28.5	Yellow	.252 6.4	165049
.106-.260 (2.7-6.6)	.598 15.2	.138 3.5	.110 2.8	1.224 31.1	Yellow	.248 6.3	160404-2

Cross Reference for Small Packaging

Standard Package	Description	Small Pack Order Number	Primary Package Quantity	Minimum Order Quantity
140714-3	.250 SERIES FAST CONNECTOR	6-1377174-6	10	200
141460-1	3.0 mm DIAMETER PIDG PIN	2-1377174-6	50	1,000
141462-1	3.0 mm DIAMETER PIDG PIN	2-1377174-4	50	1,000
165590-1	4.0 mm SHUR PLUG	2-1377174-5	50	1,000
160215	5.0 mm SHUR PLUG	2-1377174-8	50	1,000
141452-1	3.0 mm SHUR PLUG REC. ASSY.	3-1377174-1	50	1,000
141456-1	3.0 mm SHUR PLUG REC. ASSY.	2-1377174-9	50	1,000
165429-1	4.0 mm SHUR PLUG REC. ASSY.	3-1377174-2	50	1,000
165399-1	4.0 mm SHUR PLUG REC. ASSY.	5-1377175-5	50	1,000
165591-1	4.0 mm SHUR PLUG REC.	3-1377174-0	50	1,000
165400-1	SHUR PLUG REC. ASSY.	3-1377174-3	50	1,000
165046	PIDG WIRE PIN	1-1377174-3	100	2,000
165142	PIDG WIRE PIN	1-1377174-0	100	2,000
165172	PIDG WIRE PIN	1-1377174-4	100	2,000
165049	PIDG WIRE PIN ASSY.	1-1377174-7	50	1,000
165168	PIDG WIRE PIN	1-1377174-1	100	2,000
131330	PIDG WIRE PIN	1-1377174-6	100	2,000
131331	PIDG WIRE PIN	1-1377174-2	100	2,000
151467	PIDG LIPPED BLADE, Red	5-1377175-9	100	2,000
151469	PIDG LIPPED BLADE, Blue	6-1377175-0	100	2,000
151471	PIDG LIPPED BLADE, Yellow	6-1377175-1	50	1,000
9-160402-2	PIDG WIRE PIN ASSY.	1-1377174-5	100	2,000
160404-2	PIDG WIRE PIN ASSY.	1-1377174-8	50	1,000
165514-1	VINYL PIDG WIRE PIN	1377174-9	100	2,000
130207	PIDG RING TONGUE	8-1377173-1	50	1,000
328996	PIDG RING TONGUE	7-1377173-1	100	2,000
323913	PIDG RING TONGUE	6-1377173-2	100	2,000
323914	PIDG RING TONGUE	6-1377173-3	100	2,000
31880	PIDG RING TONGUE	6-1377173-6	100	2,000
320619	PIDG RING TONGUE	7-1377173-2	100	2,000
323915	PIDG RING TONGUE	6-1377173-4	100	2,000
36150	PIDG RING TONGUE	6-1377173-7	100	2,000
320565	PIDG RING TONGUE	7-1377173-3	100	2,000
323916	PIDG RING TONGUE	6-1377173-5	100	2,000
35108	PIDG RING TONGUE	7-1377173-7	50	1,000
31890	PIDG RING TONGUE	6-1377173-8	100	2,000
130094	PIDG RING TONGUE	7-1377173-4	100	2,000
130171	PIDG RING TONGUE	7-1377173-8	50	1,000
130008	PIDG RING TONGUE	6-1377173-9	100	2,000
321045	PIDG RING TONGUE	7-1377173-5	100	2,000
165034	PIDG RING TONGUE	7-1377173-9	50	1,000
31894	PIDG RING TONGUE	7-1377173-0	100	2,000
328998	PIDG RING TONGUE	7-1377173-6	100	2,000
160298	PIDG RING TONGUE	8-1377173-0	50	1,000

Cross Reference for Small Packaging (continued)

Standard Package	Description	Small Pack Order Number	Primary Package Quantity	Minimum Order Quantity
320861	PIDG SPADE FLAG	1377174-1	100	2,000
32562	PIDG SPADE FLAG	9-1377173-0	100	2,000
320862	PIDG SPADE FLAG	1377174-2	100	2,000
32510	PIDG SPADE FLAG	1377174-7	50	1,000
32498	PIDG SPADE FLAG	8-1377173-8	100	2,000
320863	PIDG SPADE FLAG	1377174-3	100	2,000
326865	PIDG SPADE END FLAG	1377174-8	50	1,000
130527	PIDG SPADE	9-1377173-2	100	2,000
321035	PIDG SPADE	8-1377173-2	100	2,000
130522	PIDG SPADE	8-1377173-4	100	2,000
32058	PIDG SPADE	9-1377173-3	100	2,000
35559	PIDG SPADE	9-1377173-4	100	2,000
323011	PIDG SPADE	8-1377173-3	100	2,000
34541	PIDG SPADE	8-1377173-5	100	2,000
326861	PIDG SPADE	9-1377173-1	100	2,000
32059	PIDG SPADE	9-1377173-7	100	2,000
130532	PIDG SPADE TONGUE	9-1377173-5	100	2,000
321233	PIDG SPADE	9-1377173-6	100	2,000
130496	PIDG SPADE	1377174-4	50	1,000
32053	PIDG SPADE	8-1377173-7	100	2,000
130517	PIDG SPADE	8-1377173-6	100	2,000
160170	PIDG SPADE	9-1377173-8	100	2,000
130620	PIDG SPADE	1377174-5	50	1,000
32054	PIDG SPADE	8-1377173-9	100	2,000
130537	PIDG SPADE	9-1377173-9	100	2,000
130625	PIDG SPADE	1377174-6	50	1,000
320562	PIDG BUTT SPLICE	2-1377174-2	50	1,000
323994	PIDG BUTT SPLICE	1-1377174-9	100	2,000
320570	PIDG BUTT SPLICE	2-1377174-3	25	500
320559	PIDG BUTT SPLICE	2-1377174-1	100	2,000
323975	PIDG BUTT SPLICE	2-1377174-0	100	2,000

Introduction

Product Facts

- Inner serrations on the wire barrel gives maximum electrical contact and tensile strength with the conductor.
- Copper sleeve provides circum-ferential insulation support to the wire and allows the wire to be bent in any direction without damaging the wire insulation or conductors.
- Insulation sleeves and corresponding tooling are color-coded by wire size for easier identification.

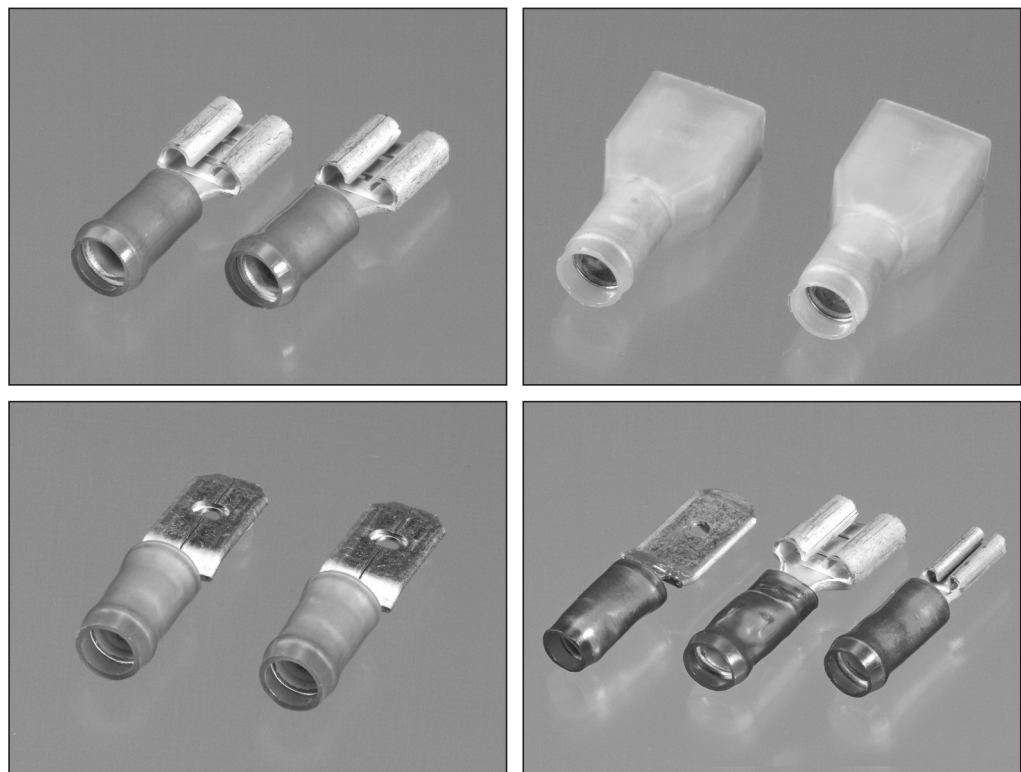
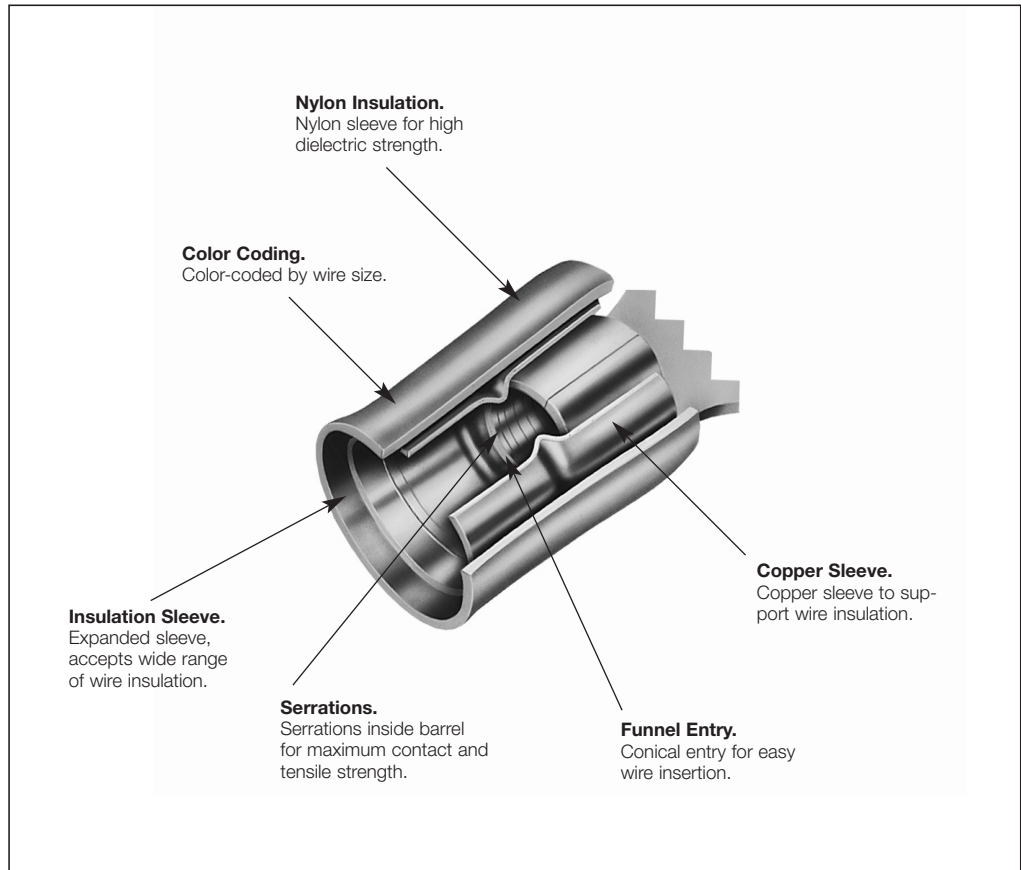

Pre-Insulated Receptacles

**Pre-Insulated
PIDG-FASTON
Receptacles**

Insulation Sleeve:
Nylon acc. UL 94 V-2

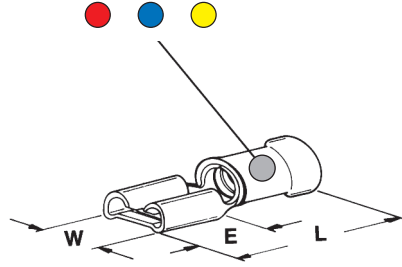

	For Tab (mm)	Wire Size Range (mm ²)	Insulation Diameter max. (mm)	Dimensions (mm)			Part Numbers	
				W	L	E	Brass, tin plated	Phosphor Bronze, tin plated
●	2.0 x 0.5	0.14–0.40	2.1	3.0	16.1	5.1	152466	–
●	2.8 x 0.3	0.30–1.50	3.5	3.7	19.8	6.3	165563-1	165563-2
●	2.8 x 0.3	1.50–2.50	4.3	3.7	19.8	6.3	165614-2	165614-5
●	2.8 x 0.4	0.30–1.50	3.5	3.7	19.8	6.3	165564-1	165564-2
●	2.8 x 0.4	1.50–2.50	4.3	3.7	19.8	6.3	165615-2	165615-5
●	2.8 x 0.5	0.14–0.40	2.1	3.8	17.4	6.3	152462	–
○	2.8 x 0.5	0.20–0.56	2.5	3.7	18.6	6.3	–	140964-1*
●	2.8 x 0.5	0.30–1.50	3.5	3.7	19.8	6.3	165565-1	165565-2
●	2.8 x 0.5	1.50–2.50	4.3	3.7	18.6	6.3	165616-2	165616-5
●	2.8 x 0.8	0.14–0.40	2.1	3.7	17.4	6.3	165619-2	165619-5
●	2.8 x 0.8	0.30–1.50	3.5	3.7	19.8	6.3	165566-1	165566-2
●	2.8 x 0.8	1.50–2.50	4.3	3.7	19.8	6.3	165617-2	165617-5
●	4.8 x 0.5	0.30–1.50	3.5	5.6	21.0	6.3	9-160481-1	9-160481-5
●	4.8 x 0.5	1.00–2.50	4.3	5.7	21.9	6.4	9-160477-2	9-160477-5
●	4.8 x 0.8	0.30–1.50	3.5	5.6	21.0	6.3	9-160483-1	9-160483-5
●	4.8 x 0.8	1.00–2.50	4.3	5.7	21.9	6.4	9-160479-2	9-160479-5
●	5.0 x 0.8	0.30–1.00	3.3	6.3	21.6	7.9	140805-2	140948-1
●	5.0 x 0.8	1.00–1.50	3.3	6.3	21.6	7.9	140805-2	140948-1
●	5.0 x 0.8	1.00–2.50	4.0	6.3	21.6	7.9	140802-2	140950-1
●	5.0 x 0.8	3.00–3.40	4.0	6.3	21.6	7.9	140802-2	140950-1
●	6.3 x 0.8	0.30–1.50	3.5	7.6	22.2	7.7	9-160583-2	9-160583-5
●	6.3 x 0.8	1.00–2.50	4.3	7.6	23.2	7.7	9-160313-2	9-160313-5
●	6.3 x 0.8	4.00–6.00	6.3	7.6	27.2	7.7	160314-2	160314-5

*) **Color:** Transparent

Fully-Insulated Receptacles

Fully-Insulated
 PIDG-FASTON
 Receptacles

Insulation Sleeve:
 Nylon acc. UL 94 V-2

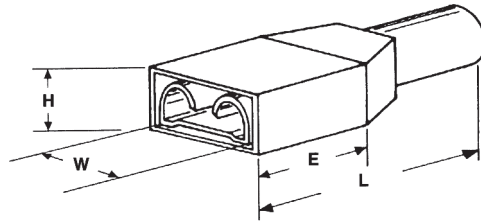

	For Tab (mm)	Wire Size Range (mm ²)	Insulation Diameter max. (mm)	Dimensions (mm)				Part Numbers	
				W	L	E	H	Brass, tin plated	Phosphor Bronze, tin plated
●	6.3 x 0.8	0.3–1.0	3.3	9.2	21.6	7.8	5.3	735278	735278-1
●	6.3 x 0.8	1.0–1.5	3.3	9.2	21.6	7.8	5.3	735278	735278-1
●	6.3 x 0.8	0.3–1.0	3.3	9.2	21.6	7.8	5.3	735279	–
●	6.3 x 0.8	1.5–2.5	4.0	9.2	21.6	7.8	5.3	735159	–
●	6.3 x 0.8	1.0–2.5	4.0	9.2	21.6	7.8	5.3	735160	–

PIDG-FASTON
 Flag Version

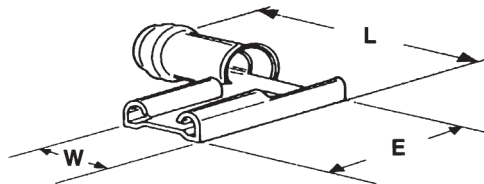

	For Tab (mm)	Wire Size Range (mm ²)	Insulation Diameter max. (mm)	Dimensions (mm)			Part Numbers	
				W	L	E	Brass, tin plated	Phosphor Bronze, tin plated
●	6.3 x 0.8	0.3–1.5	3.4	7.6	18.3	15.5	156667-1	–
●	6.3 x 0.8	1.0–2.5	4.0	7.6	18.3	15.5	156666-1	–
●	6.3 x 0.8	1.5–2.5	4.0	7.6	18.3	15.5	156666-1	–

PIDG-FASTON
 Receptacles
 Piggy Back Style

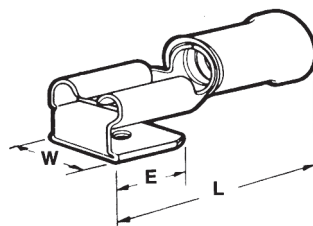

	For Tab (mm)	Wire Size Range (mm ²)	Insulation Diameter max. (mm)	Dimensions (mm)			Part Numbers	
				W	L	E	Brass, tin plated	Phosphor Bronze, tin plated
●	6.3 x 0.8	0.3–1.5	3.5	7.6	23.4	7.7	9-160834-2	9-160834-5
●	6.3 x 0.8	1.0–2.5	4.3	7.6	23.4	7.7	9-160463-2	9-160463-5

Receptacles and Tabs

PIDG – Positive Lock Receptacle

Low Insertion Force with Locking Device and Vibration Resistance

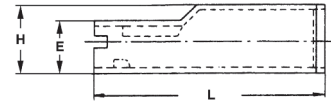
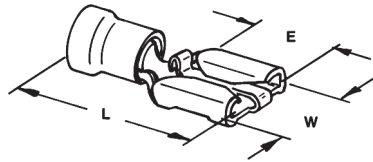

Housing for Full Protection and Easy Release

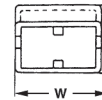

For Tab (mm)	Wire Size Range (mm ²)	Insulation Diameter max. (mm)	Dimensions (mm)				Part Numbers	
			W	L	E	H	Brass, tin plated	Phosphor Bronze, tin plated
● 6.3 x 0.8	1.5–2.5	4.8	9.2	21.6	8.0	–	165536-1	165536-2
Housing: Neutral			9.8	24.3	5.7	7.2	154719	–
Housing: Black			9.8	24.3	5.7	7.2	154719-1	–

PIDG-FASTON Tab

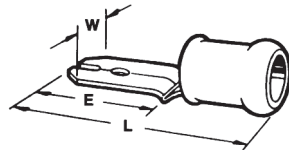

For Tab (mm)	Wire Size Range (mm ²)	Insulation Diameter max. (mm)	Dimensions (mm)			Part Numbers	
			W	L	E	Brass, tin plated	Phosphor Bronze, tin plated
● 6.3 x 0.8	0.5–1.0	3.3	6.3	23.5	9.4	140896-2	–
● 6.3 x 0.8	1.0–2.5	3.9	6.3	23.5	9.4	140971-2	–
● 6.3 x 0.8	4.0–6.0	5.7	6.3	28.0	9.4	141085-2	–

PIDG-FASTON Receptacles for Automotive Applications as Head Lights

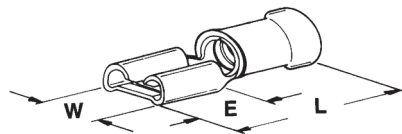

For Tab (mm)	Wire Size Range (mm ²)	Insulation Diameter max. (mm)	Dimensions (mm)			Part Numbers	
			W	L	E	Brass, tin plated	Phosphor Bronze, tin plated
● 8.0 x 0.75	1.0–2.5	4.3	9.0	24.4	14.6	9-160326-2	–

PIDG-FASTON Receptacles for Tab for Alternators/Bus-Bars

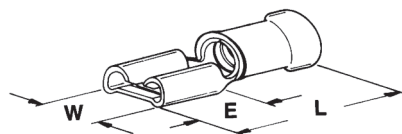

For Tab (mm)	Wire Size Range (mm ²)	Insulation Diameter max. (mm)	Dimensions (mm)			Part Numbers	
			W	L	E	Brass, tin plated	Phosphor Bronze, tin plated
● 9.5 x 1.2	4.0–6.0	6.3	11.0	30.7	11.9	160524-2	160524-4

Cross Reference for Small Packaging

Standard Package	Description	Small Pack Order Number	Primary Package Quantity	Minimum Order Quantity
181949-2	.250 FASTON TAB	6-1377174-3	50	1,000
181949-1	.250 FASTON TAB	6-1377174-2	50	1,000
140665	.250 FASTON TAB	6-1377174-1	50	1,000
181948-1	.250 SERIES FASTON TAB	6-1377174-4	50	1,000
735052	2.8 FASTON REC. SLEEVE	7-1377174-3	100	2,000
925387-1	AMP PIP POD HOUSING	7-1377174-0	100	2,000
1-480435-0	.187 FASTON HOUSING	7-1377174-1	50	1,000
735075	.250 FASTON REC. SLEEVE	7-1377174-6	50	1,000
925068	.250 FASTON REC. SLEEVE	7-1377174-2	50	1,000
926539-1	.250 FASTON INS. BOOT	7-1377174-4	50	1,000
926539-5	.250 P.I. FASTON HOUSING	7-1377174-5	50	1,000
1-925017-0	INSULATION SLEEVE	6-1377174-9	50	1,000
2-180930-0	INSULATION CLEAR	6-1377174-8	50	1,000
180909	FASTON CONNECTOR	6-1377174-7	10	200
41291	.250 SERIES FASTON TAB	6-1377174-0	50	1,000
41480	.250 SERIES FASTON TAB	5-1377174-7	50	1,000
140734-1	FASTON TAB	5-1377174-4	50	1,000
140814-1	FASTON TAB	5-1377174-1	50	1,000
140814-2	FASTON TAB	5-1377174-2	50	1,000
141879-1	.250 FASTON TAB	5-1377174-3	100	2,000
142241-1	.250 FASTON TAB	5-1377174-6	50	1,000
140608	.250 FASTON TAB	5-1377174-5	50	1,000
141878-1	.250 FASTON TAB	5-1377174-8	50	1,000
141878-2	.250 FASTON TAB	5-1377174-9	50	1,000
1-160304-8	.250 SERIES FASTON REC.	4-1377174-7	100	2,000
160625-2	.110 SERIES FASTON REC.	3-1377174-5	100	2,000
5-160321-2	.110 SERIES FASTON REC.	3-1377174-4	100	2,000
160626-2	.110 SERIES FASTON REC.	3-1377174-7	100	2,000
160626-1	.110 SERIES FASTON REC.	3-1377174-6	100	2,000
5-160491-2	.187 SERIES FASTON REC.	4-1377174-0	100	2,000
5-160490-1	.187 SERIES FASTON REC.	3-1377174-8	100	2,000
5-160491-1	.187 SERIES FASTON REC.	3-1377174-9	100	2,000
5-160506-2	.250 SERIES FASTON REC.	4-1377174-2	100	2,000
1-160304-2	.250 SERIES FASTON REC.	4-1377174-5	100	2,000
1-160305-6	.250 SERIES FASTON REC.	4-1377174-9	100	2,000
5-160506-1	.250 SERIES FASTON REC.	4-1377174-1	100	2,000
1-160304-0	.250 SERIES FASTON REC.	4-1377174-4	100	2,000
1-160305-3	.250 SERIES FASTON REC.	4-1377174-8	100	2,000
5-160506-3	.250 SERIES FASTON REC.	4-1377174-3	50	1,000
2-160304-4	.250 SERIES FASTON REC.	4-1377174-6	50	1,000
160305-5	.250 SERIES FASTON REC.	5-1377174-0	50	1,000
163179-1	.250 LINE SPL CONN AS	6-1377174-5	10	200
165616-5	.110 PIDG FASTON REC.	9-1377174-6	50	1,000
165565-2	2.8 PIDG FASTON REC.	8-1377174-2	50	1,000
165617-5	110 PIDG FASTON REC.	9-1377174-8	100	2,000
165619-5	110 PIDG FASTON REC.	7-1377174-8	50	1,000

Cross Reference for Small Packaging (continued)

Standard Package	Description	Small Pack Order Number	Primary Package Quantity	Minimum Order Quantity
165566-2	.110 PIDG FASTON REC.	8-1377174-4	50	1,000
9-160477-5	.187 PIDG FASTON REC.	1377175-1	100	2,000
9-160481-5	.187 PIDG FASTON REC.	8-1377174-6	100	2,000
9-160479-5	.187 PIDG FASTON REC.	1377175-3	100	2,000
9-160483-5	.187 PIDG FASTON REC.	8-1377174-8	100	2,000
140950-1	.197 PIDG FASTON REC.	1377175-5	100	2,000
140948-1	.197 PIDG FASTON REC.	9-1377174-0	100	2,000
9-160313-5	.250 PIDG FASTON REC.	1377175-7	100	2,000
160314-5	.250 PIDG FASTON REC.	1-1377175-0	50	1,000
9-160583-5	.250 PIDG FASTON REC.	9-1377174-2	100	2,000
165614-2	.110 PIDG FASTON REC.	9-1377174-3	100	2,000
165563-1	.110 PIDG FASTON REC.	7-1377174-9	50	1,000
165615-2	.110 PIDG FASTON REC.	9-1377174-4	100	2,000
165564-1	.110 PIDG FASTON REC.	8-1377174-0	50	1,000
165616-2	.110 PIDG FASTON REC.	9-1377174-5	50	1,000
165565-1	2.8 PIDG FASTON REC.	8-1377174-1	50	1,000
165617-2	.110 PIDG FASTON REC.	9-1377174-7	100	2,000
165619-2	.110 PIDG FASTON REC.	7-1377174-7	50	1,000
165566-1	.110 PIDG FASTON REC.	8-1377174-3	50	1,000
9-160477-2	.187 PIDG FASTON REC.	9-1377174-9	100	2,000
9-160481-1	4.8 PIDG FASTON REC.	8-1377174-5	50	1,000
9-160479-2	.187 PIDG FASTON REC.	1377175-2	100	2,000
9-160483-1	4.8 PIDG FASTON REC.	8-1377174-7	50	1,000
140802-2	.197 PIDG FASTON REC.	1377175-4	100	2,000
140805-2	.197 PIDG FASTON REC.	8-1377174-9	100	2,000
9-160313-2	.250 PIDG FASTON REC.	1377175-6	100	2,000
160314-2	.250 FASTON	1377175-9	50	1,000
9-160583-2	.250 PIDG FASTON REC.	9-1377174-1	100	2,000
9-160326-2	.312 PIDG FASTON REC.	1377175-8	100	2,000
160524-2	.375 PIDG FASTON REC.	1-1377175-1	50	1,000
9-160463-5	6.3 P.B.FASTON REC.	2-1377175-2	50	1,000
160834-5	PIDG PIGGY-BACK FASTON	2-1377175-0	100	2,000
9-160463-2	PIDG PIGGY-BACK FASTON	2-1377175-1	50	1,000
160834-2	PIDG PIGGY-BACK FASTON	1-1377175-9	50	1,000
735278-1	.250 PIDG F.I.F. REC.	1-1377175-3	100	2,000
735279	.250 PIDG F.I.F. REC.	1-1377175-4	50	1,000
735278	.250 PIDG F.I.F. REC.	1-1377175-2	100	2,000
735160	.250 PIDG FASTON REC.	1-1377175-5	100	2,000
735159	6.3 F.I.F. REC.	1-1377175-6	50	1,000
140971-2	PIDG TAB	2-1377175-4	50	1,000
141085-2	.250 PIDG FASTON TAB	2-1377175-5	50	1,000
140896-2	.250 PIDG FASTON TAB	2-1377175-3	50	1,000
156667-1	PIDG FL. FASTON REC.	1-1377175-7	50	1,000
156666-1	PIDG FL. FASTON REC.	1-1377175-8	50	1,000
165536-2	PIDG POSITIVE LOCK ASSY.	2-1377175-7	50	1,000
165536-1	PIDG POSITIVE LOCK ASSY.	2-1377175-6	50	1,000

Application Tooling

**Hand Tooling for PIDG
Terminals and Splices**

Tool Grade	Wire Size		Description	Part Number	Instruction Sheet
	(mm ²)	(AWG)			
Service	0.4–6.0	22–10	SUPER CHAMP II	169060-8	–
	0.1–0.4	26–22	Die-Set – Service Kit Tool	3-1579016-1*	–
	4.0–6.0	12–10			
	0.5–1.5	22–16	Die-Set – Service Kit Tool	3-1579016-2*	–
	1.5–2.5	16–14			
Commercial	0.4–6.0	22–10	SDE PRO-CRIMPER III (Tool & Die-Set)	58433-3	408-9252
Premium	0.15–0.40	26–22	Double Action Hand Tool (DAHT)	46121	408-1559
	0.4–1.5	22–16		47386	408-1559
	1.5–2.5	16–14	47387	408-1559	
	0.4–6.0	22–10	TETRA-CRIMP Hand Tool	59824-1	408-2823
	4.0–6.0	12–10	Heavy Head Hand Tool (HHHT)	59239-4	408-1261
		16–14 HD		59287-2	

*) Use in Hand Tool, Part No. **3-1579000-0**.

Find the latest tooling and equipment options and alternatives including powered at
<http://www.tooling.tycoelectronics.com/europe/handtool.stm>

Engineering Notes

A large grid area for engineering notes, consisting of a uniform grid of small squares. The grid is empty and occupies the majority of the page's vertical space.