

LOW FREQUENCY TRANSISTER (20V, 3A)

2SD2150

FEATURES

- Low $V_{CE(sat)}$: $V_{CE(sat)} = 0.2V(Typ.)$
($I_C/I_B = 2A/0.1A$).
- Excellent current gain characteristics.
- Complements the 2SB1424.

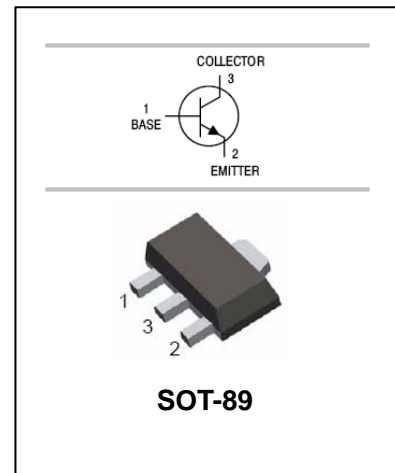

Structure

Epitaxial planar type NPN silicon transistor.

ORDERING INFORMATION

Type No.	Marking	Package Code
2SD2150	CFR	SOT-89

MAXIMUM RATING @ $T_a = 25^\circ C$ unless otherwise specified

Symbol	Parameter	Value	Unit
V_{CBO}	Collector-Base Voltage	40	V
V_{CEO}	Collector-Emitter Voltage	20	V
V_{EBO}	Emitter-Base Voltage	6	V
I_C	Collector Current -Continuous	3 5	A(DC) A(Pulse) ^{*1}
P_C	Collector power dissipation	0.5	W
T_j	Junction Temperature	150	$^\circ C$
T_{stg}	Storage Temperature	-55 to +150	$^\circ C$

*1 Single pulse $P_w = 10ms$



LOW FREQUENCY TRANSISTER (20V, 3A)

2SD2150

ELECTRICAL CHARACTERISTICS @ Ta=25°C unless otherwise specified

Parameter	Symbol	Test conditions	MIN	TYP	MAX	UNIT
Collector-base breakdown voltage	$V_{(BR)CBO}$	$I_C=50\mu A, I_E=0$	40			V
Collector-emitter breakdown voltage	$V_{(BR)CEO}$	$I_C=1mA, I_B=0$	20			V
Emitter-base breakdown voltage	$V_{(BR)EBO}$	$I_E=50\mu A, I_C=0$	6			V
Collector cut-off current	I_{CBO}	$V_{CB}=30V, I_E=0$			0.1	μA
Emitter cut-off current	I_{EBO}	$V_{EB}=5V, I_C=0$			0.1	μA
Collector-emitter saturation voltage	$V_{CE(sat)}$	$I_C/I_B=2A/0.1A$		0.2	0.5	V
DC current transfer ratio	h_{FE}	$V_{CE}=2V, I_C=0.1A$	120		560	h_{FE}
Transition frequency	f_T	$V_{CE}=2V, I_E=-0.5A,$ $f=100MHz$		290		MHz
Output Capacitance	C_{ob}	$V_{CB}=10V, f=1MHz, I_E=0A$		25		pF

*Measured using pulse current

CLASSIFICATION OF h_{FE}

Rank	Q	R	S
Range	120-270	180-390	270-560

LOW FREQUENCY TRANSISTER (20V, 3A)

2SD2150

TYPICAL CHARACTERISTICS @ Ta=25°C unless otherwise specified

● Electrical characteristic curves

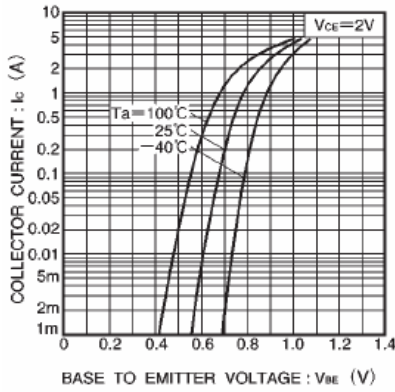

Fig.1 Grounded emitter propagation characteristics

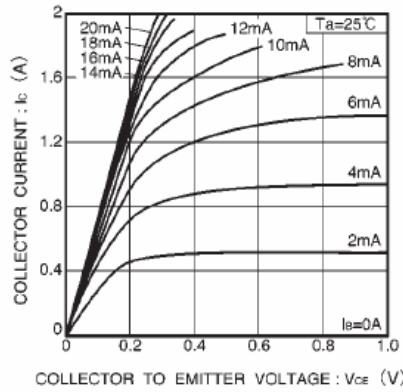

Fig.2 Grounded emitter output characteristics (I)

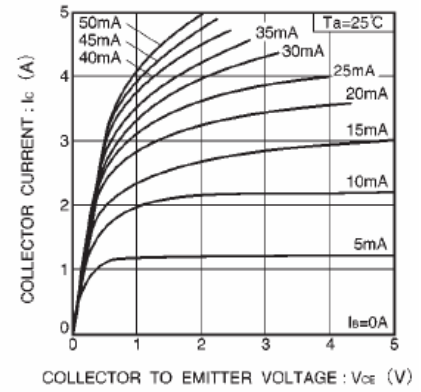

Fig.3 Grounded emitter output characteristics (II)

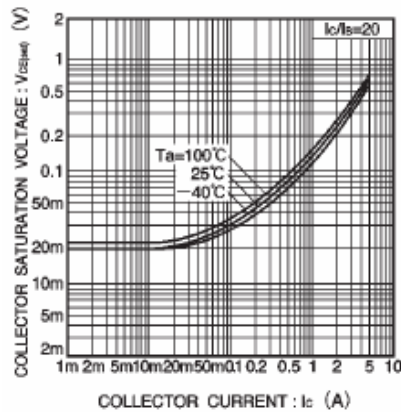

Fig.7 Collector-emitter saturation voltage vs. collector current (III)

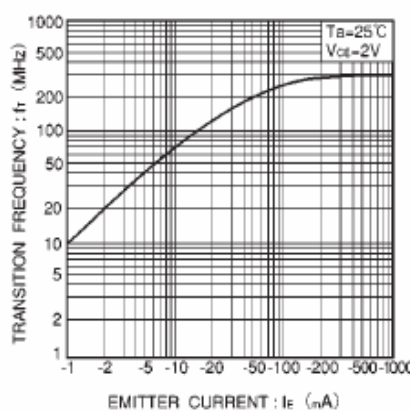

Fig.8 Gain bandwidth product vs. emitter current

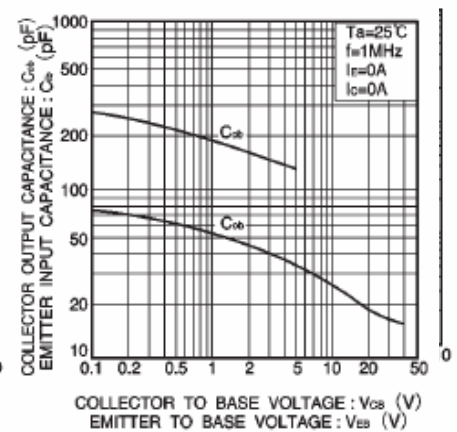

Fig.9 Collector output capacitance vs. collector-base voltage
Emitter input capacitance vs. emitter-base voltage



LOW FREQUENCY TRANSISTER (20V, 3A)

2SD2150

PACKAGE OUTLINE

Plastic surface mounted package

SOT-89

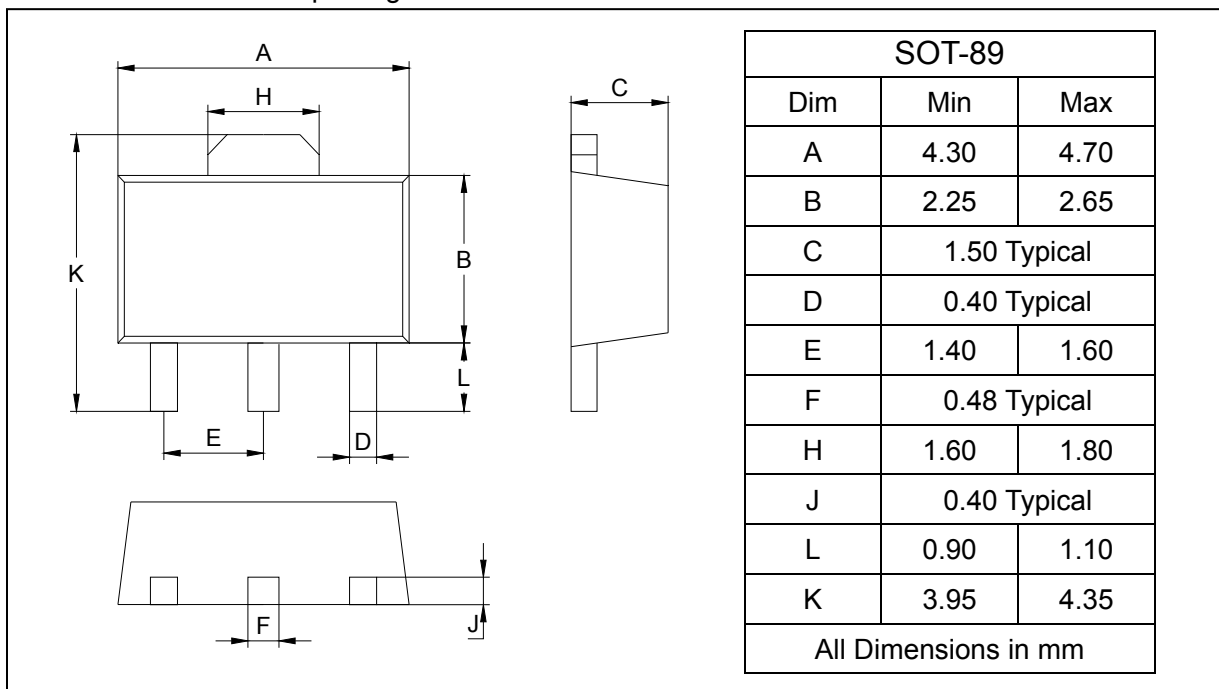

SOLDERING FOOTPRINT

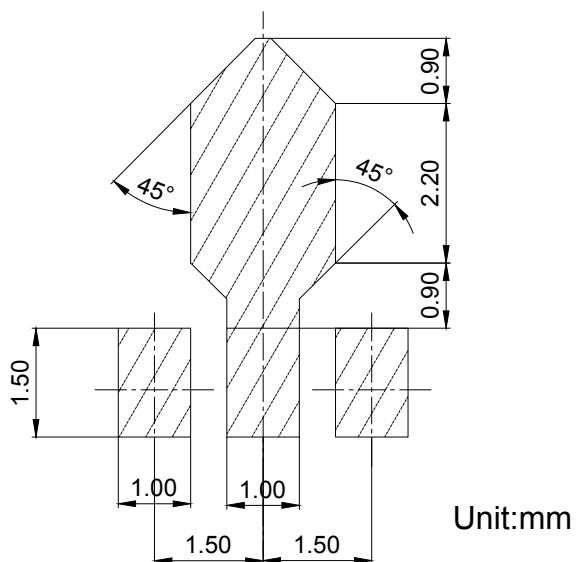

PACKAGE INFORMATION

Device	Package	Shipping
2SD2150	SOT-89	1000/Tape&Reel