



C2C-SA06010A10000, C2C-EA06010A10000

deTec2 Core

SAFETY LIGHT CURTAINS

SICK
Sensor Intelligence.



Ordering information

System part	Type	Part no.
Sender	C2C-SA06010A10000	1213191
Receiver	C2C-EA06010A10000	1213192

Other models and accessories → www.sick.com/deTec2_Core



Detailed technical data

Features

System part	Sender/receiver pair with QuickFix bracket
Resolution	14 mm
Protective field height	600 mm
Scanning range	Minimum 0 m ... 7 m
	Typical 0 m ... 8 m
Response time	13 ms
Synchronization	Optical synchronisation

Safety-related parameters

Type	Type 2 (IEC 61496)
Safety integrity level	SIL1 (IEC 61508) SILCL1 (EN 62061)
Category	Category 2 (EN ISO 13849)
Performance level	PL c (EN ISO 13849)
PFH_D (mean probability of a dangerous failure per hour)	3.1×10^{-8} (EN ISO 13849)
T_M (mission time)	20 years (EN ISO 13849)
Safe state in the event of a fault	At least one OSSD is in the OFF state.

Interfaces

System connection	Connection type	Male connector M12, 5-pin
	Permitted cable length	≤ 50 m
Fieldbus, industrial network		
Integration via Flexi Soft safety controller		CANopen, DeviceNet™, EtherCAT®, EtherNet/IP™, Modbus TCP, PROFIBUS DP, PROFINET ¹⁾

¹⁾ For additional information on Flexi Soft -> www.sick.com/Flexi_Soft.

Electrical data

Protection class	III (EN 50178)
Supply voltage V_S	24 V DC (19.2 V ... 28.8 V)
Ripple	$\leq 2.4 V_{pp}^{1)}$
Power consumption typical	2.4 W (DC) / 1.2 W (DC) (depending on type)
Safety outputs (OSSD)	
Type of output	2 PNP semiconductors, short-circuit protected, cross-circuit monitored ²⁾
Switching voltage HIGH	24 V DC ($V_S - 2.25$ V DC ... V_S)
Switching voltage LOW	≤ 2 V DC
Switching current	≤ 300 mA

¹⁾ Within the limits of V_S .

²⁾ Applies to the voltage range between -30 V and +30 V.

Mechanical data

Housing cross-section (incl. system connection)	34 mm x 30.7 mm
Housing material	Aluminum extruded profile
Weight	580 g / 570 g (depending on type)

Ambient data

Enclosure rating	IP65 (EN 60529) IP67 (EN 60529)
Ambient operating temperature	-30 °C ... +55 °C
Storage temperature	-30 °C ... +70 °C
Air humidity	15 % ... 95 %, Non-condensing
Vibration resistance	5 g, 10 Hz ... 55 Hz (EN 60068-2-6)
Shock resistance	10 g, 16 ms (EN 60068-2-29)

Other information

Wave length	850 nm
--------------------	--------

Classifications

ECl@ss 5.0	27272704
ECl@ss 5.1.4	27272704
ECl@ss 6.0	27272704
ECl@ss 6.2	27272704
ECl@ss 7.0	27272704
ECl@ss 8.0	27272704
ECl@ss 8.1	27272704
ECl@ss 9.0	27272704
ETIM 5.0	EC002549
ETIM 6.0	EC002549
UNSPSC 16.0901	46171620

Dimensional drawing (Dimensions in mm (inch))

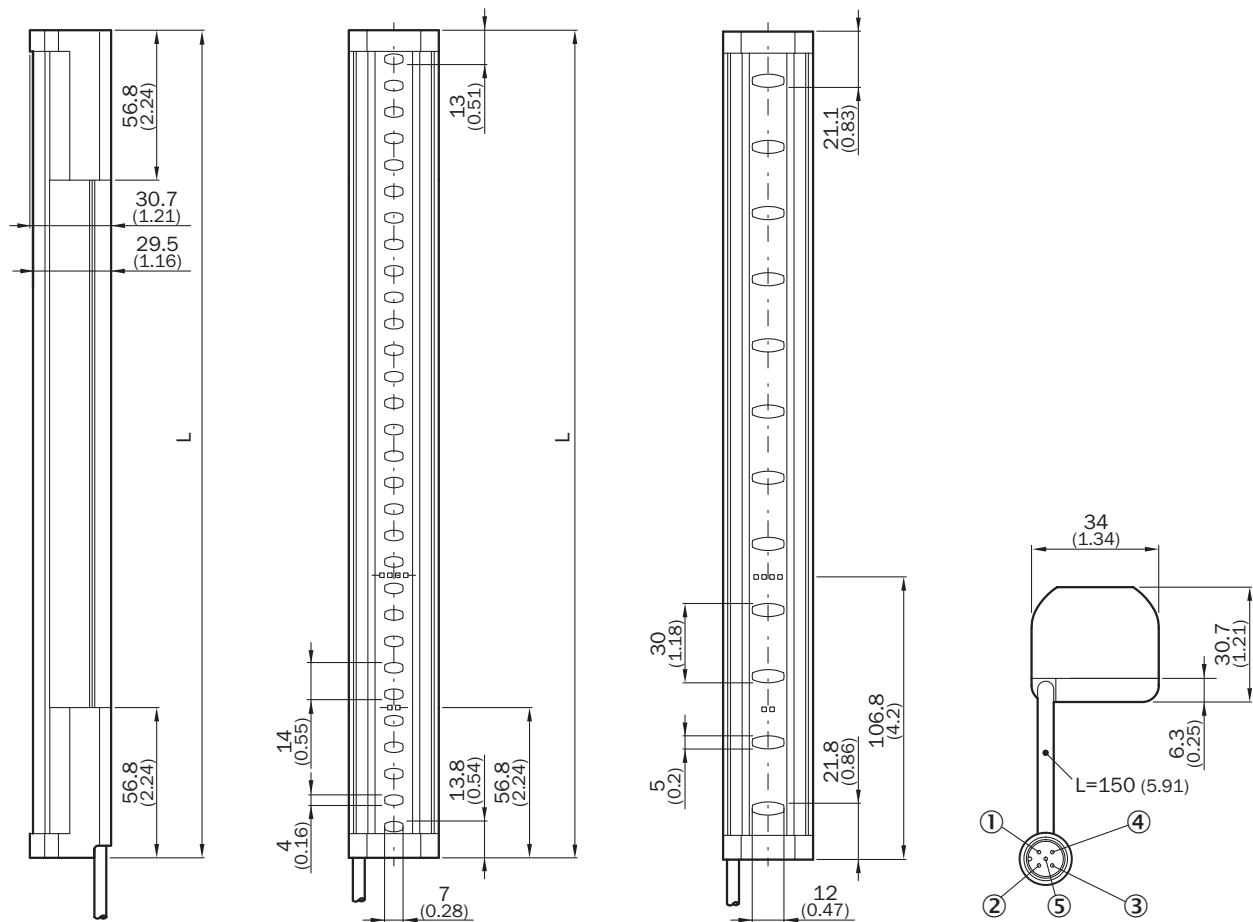

Protective field height	L
300 (11.81)	313 (12.32)
450 (17.72)	463 (18.23)
600 (23.62)	613 (24.13)
750 (29.53)	763 (30.04)
900 (35.43)	913 (35.94)
1,050 (41.34)	1,063 (41.85)
1,200 (47.24)	1,213 (47.76)
1,350 (53.15)	1,362 (53.62)
1,500 (59.06)	1,512 (59.53)
1,650 (64.96)	1,662 (65.43)
1,800 (70.87)	1,812 (71.34)
1,950 (76.77)	1,962 (77.24)
2,100 (82.68)	2,112 (83.15)

Connection diagram

deTec2 Core safety light curtain connected to UE48-20S safety relay

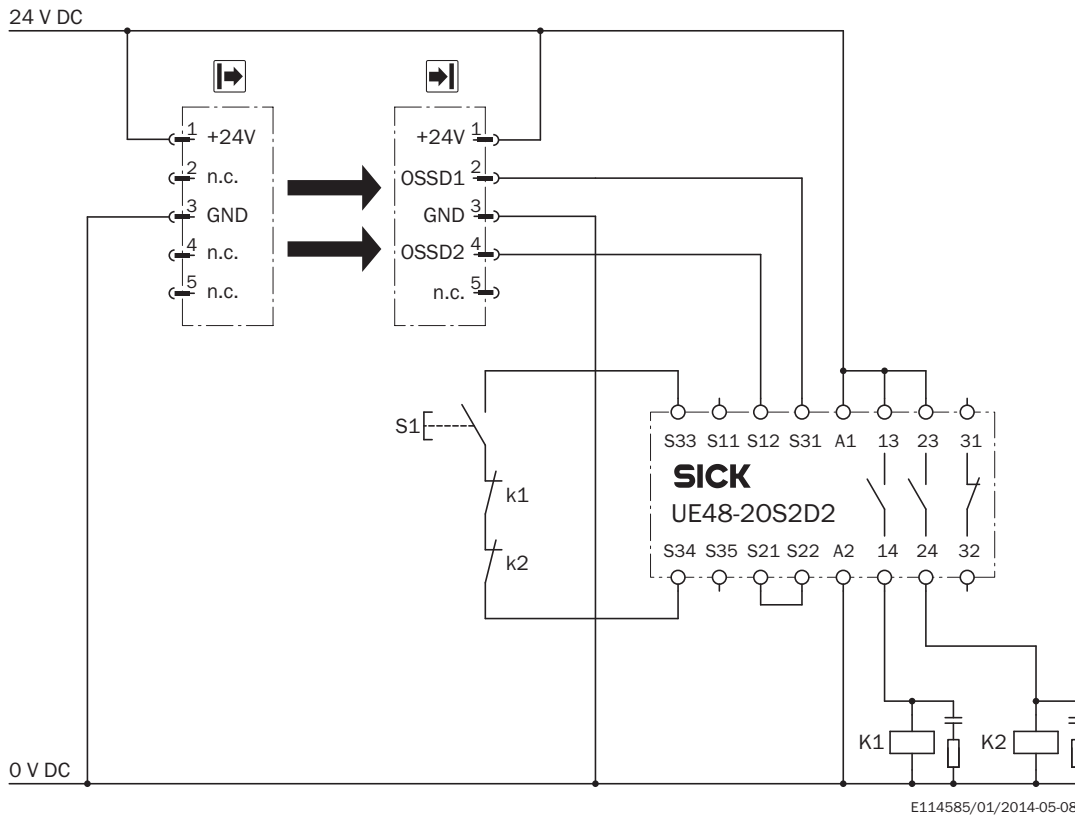

Task

Connection of a deTec2 Core safety light curtain to UE48-20S.

Operating mode: with restart interlock and external device monitoring.

Function

When the light path is clear, the OSSD1 and OSSD2 outputs are live. The system is ready to switch on if K1 and K2 are de-energized. By pressing S1 (button is pressed and released), the UE48-20S is energized and its 13 - 14 and 23 - 24 contacts activate K1 and K2. On interruption of one of the light beams, the UE48-20S is de-energized by the OSSD1 and OSSD2 outputs and K1 and K2 are deactivated.

Fault analysis

OSSD cross-circuits and short-circuits are detected and lead to the inhibited state (lock-out). The incorrect functioning of one of the K1 or K2 contactors will be detected and does not result in the loss of the shutdown function. Jamming of the S1 button will prevent the UE48-20S from enabling.

Comments

¹⁾ Output circuits: These contacts are to be connected to the controller such that, with the output circuit open, the dangerous state is disabled. For categories 4 and 3, the integration must be dual-channel (x/y paths). Single-channel integration in the control (z path) is only possible with a single-channel control and by taking the risk analysis into account.

SICK AT A GLANCE

SICK is one of the leading manufacturers of intelligent sensors and sensor solutions for industrial applications. A unique range of products and services creates the perfect basis for controlling processes securely and efficiently, protecting individuals from accidents and preventing damage to the environment.

We have extensive experience in a wide range of industries and understand their processes and requirements. With intelligent sensors, we can deliver exactly what our customers need. In application centers in Europe, Asia and North America, system solutions are tested and optimized in accordance with customer specifications. All this makes us a reliable supplier and development partner.

Comprehensive services complete our offering: SICK LifeTime Services provide support throughout the machine life cycle and ensure safety and productivity.

For us, that is “Sensor Intelligence.”

WORLDWIDE PRESENCE:

Contacts and other locations –www.sick.com