



Thin-Film Cascadable Amplifier 10 to 1500 MHz

Technical Data

UTO/UTC 1524 Series

Features

- **Frequency Range: 10 to 1500 MHz**
- **High Gain: 22.0 dB (Typ)**
- **Medium Output Power: +10 dBm (Typ)**
- **Temperature Compensated**

Applications

- **IF/RF Amplification**

Description

The 1524 Series is a two-stage bipolar RF amplifier built on a thin-film substrate. Active bias and resistive feedback provide for stability over temperature and bias voltage variations. Input/output blocking capacitors couple the RF through the amplifier, and a low VSWR is maintained through inductive tuning. The 1524 Series our amplifiers are available in either the TO-8 hermetic case or connected TC-1A package.

Pin Configuration UTO—TO-8U

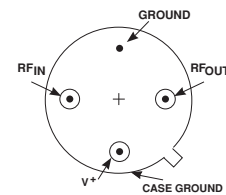

UTC—TC-1A

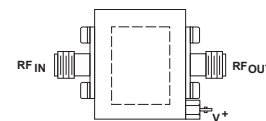

Schematic

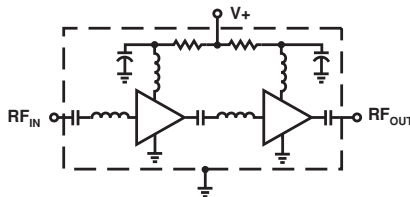

Maximum Ratings

Parameter	Maximum
DC Voltage	+17 Volts
Continuous RF Input Power	+13 dBm
Operating Case Temperature	-55 to +125°C
Storage Temperature	-62 to +150°C
"R" Series Burn-In Temperature	+125°C

Thermal Characteristics¹

θ_{JC}	105/75°C/W ²
Active Transistor Power Dissipation	102/340 mW ²
Junction Temperature Above Case Temperature	11/26°C ²
MTBF (MIL-HDBK-217E, A_{UF} @ 90°C)	586,100 Hrs.

Notes:

1. Values refer to first and second stages, respectively.

Weight: (typical) UTO—2.1 grams; UTC—21.5 grams

Electrical Specifications

(Measured in 50 Ω system @ +15 VDC nominal unless otherwise noted)

Symbol	Characteristic	Typical $T_C = 25^\circ\text{C}$	Guaranteed Specifications		Unit
			$T_C = 0 \text{ to } 50^\circ\text{C}$	$T_C = -55 \text{ to } +85^\circ\text{C}$	
BW	Frequency Range	10-1500	10-1500	10-1500	MHz
GP	Small Signal Gain (Min.)	22.0	21.0	20.0	dB
—	Gain Flatness (Max.)	± 0.4	± 1.5	± 1.5	dB
NF	Noise Figure (Max.)	4.0	4.5	5.0	dB
P_{1dB}	Power Output @ +1 dB Comp. (Min.)	+10.0	+7.0	+6.0	dBm
—	Input VSWR (Max.)	—	2.0:1	2.0:1	—
—	Output VSWR (Max.)	—	2.0:1	2.0:1	—
IP_3	Two Tone 3rd Order Intercept Point	+19.0	—	—	dBm
IP_2	Two Tone 2nd Order Intercept Point	+22.0	—	—	dBm
HP_2	One Tone 2nd Order Intercept Point	+27.0	—	—	dBm
I_D	DC Current	60	—	—	mA

Typical Performance Over Temperature (@ +15 VDC unless otherwise noted)

Key: +25°C —
+85°C - -
-55°C = =

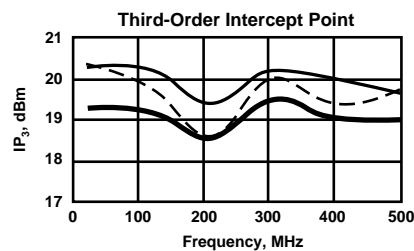
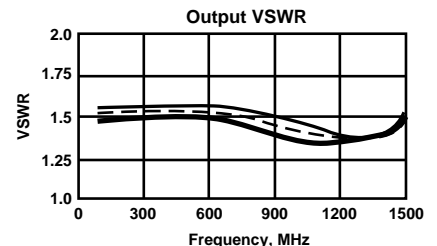
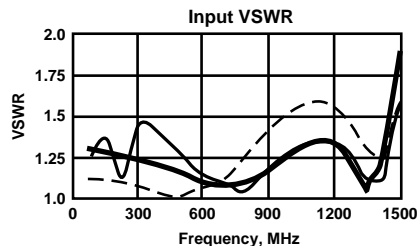
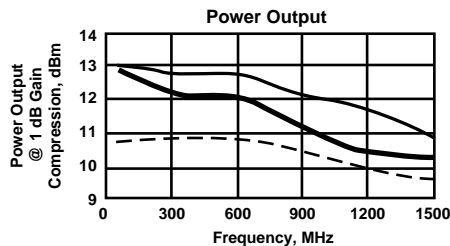
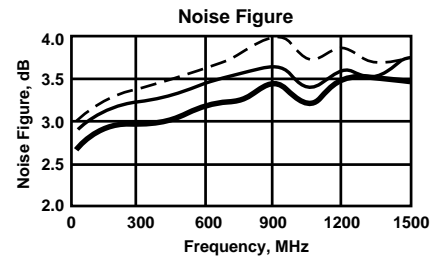
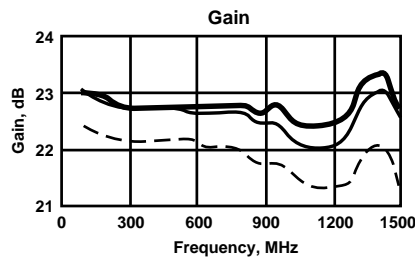

Automatic Network Analyzer Measurements (Typical production unit @ +25°C ambient)**Numerical Readings****Bias = 15.00 Volts**

FREQUENCY MHz	VSWR IN	GAIN dB	PHASE DEGREES	PHASE DEV	GROUP DELAY ns	VSWR OUT	ISOLATION dB
100.0	1.01	22.53	-15.01	-3.10	.00	1.58	36.39
200.0	1.02	22.48	-30.29	-2.39	.44	1.57	35.33
300.0	1.03	22.54	45.95	-2.02	.42	1.56	36.49
400.0	1.03	22.61	-60.93	-.99	.39	1.56	36.32
500.0	1.04	22.52	-74.88	1.07	.39	1.55	36.61
600.0	1.05	22.47	-89.61	2.35	.45	1.53	37.27
700.0	1.07	22.47	-105.97	2.00	.46	1.50	37.75
800.0	1.10	22.61	-122.32	1.66	.46	1.45	38.40
900.0	1.14	22.80	-138.12	1.85	.41	1.38	38.91
1000.0	1.18	22.80	-153.28	2.71	.43	1.30	39.35
1100.0	1.24	22.86	-169.08	2.91	.46	1.21	39.71
1200.0	1.30	22.84	173.66	1.66	.50	1.13	41.39
1300.0	1.37	22.79	155.74	-.23	.52	1.06	41.92
1400.0	1.48	22.85	136.39	-3.56	.52	1.00	43.37
1500.0	1.64	22.62	117.14	-6.80	.56	1.02	44.35

Linearization Range: 100.0 to 1500.0 MHz

S-Parameters**Bias = 15.00 Volts**

FREQUENCY MHz	S ₁₁		S ₂₁		S ₁₂		S ₂₂	
	Mag	Ang	dB	Ang	dB	Ang	Mag	Ang
100.00	.019	-174.1	22.562	-15.2	-34.760	8.0	.226	172.6
200.00	.028	-124.8	22.576	-30.1	-35.860	.7	.222	169.1
300.00	.036	-116.0	22.522	-45.1	-35.616	-14.3	.219	161.8
400.00	.039	-108.4	22.496	-60.4	-35.936	-17.4	.219	155.1
500.00	.040	-95.5	22.486	-75.9	-36.753	-19.9	.215	147.4
600.00	.045	-86.1	22.593	-91.1	-36.615	-26.9	.207	140.0
700.00	.053	-78.8	22.690	-106.5	-37.868	-31.7	.195	130.8
800.00	.065	-82.3	22.812	-122.0	-38.339	-35.4	.178	121.8
900.00	.075	-91.4	22.902	-137.1	-38.262	-41.2	.156	109.7
1000.00	.085	-110.6	22.924	-153.1	-39.934	-39.0	.130	98.6
1100.00	.098	-135.6	22.974	-169.1	-40.571	-43.4	.098	84.6
1200.00	.121	-165.5	23.002	174.1	-41.071	-49.8	.064	71.3
1300.00	.154	164.4	23.033	156.4	-42.089	-52.1	.034	58.2
1400.00	.205	137.1	22.926	137.4	-42.274	-52.9	.007	87.3
1500.00	.264	109.5	22.734	117.8	-44.008	-65.3	.018	146.9
1600.00	.323	82.4	22.295	97.4	-46.629	-60.4	.026	109.8
1700.00	.372	56.6	21.600	77.3	-51.695	-32.0	.030	44.7
1800.00	.412	32.4	20.622	58.9	-45.624	-4.4	.050	-22.0

Product Options

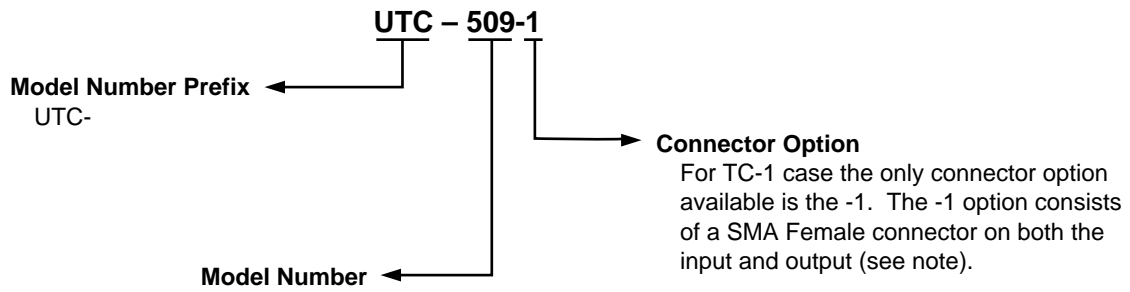
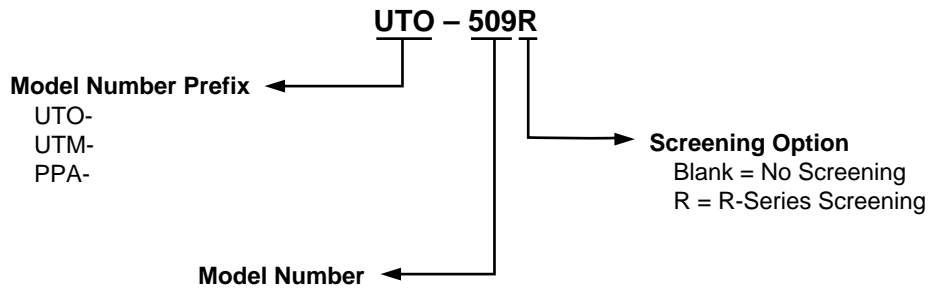

Note: R-Series screening is not available in the TC-1 case as the case is non-hermetic.

**Case Drawings
TO-8U**

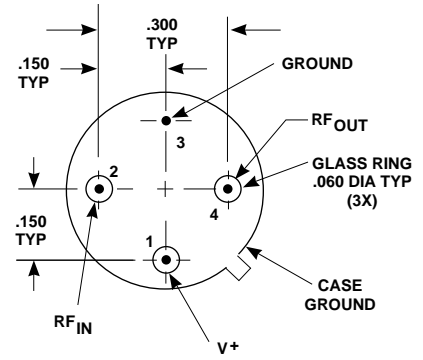
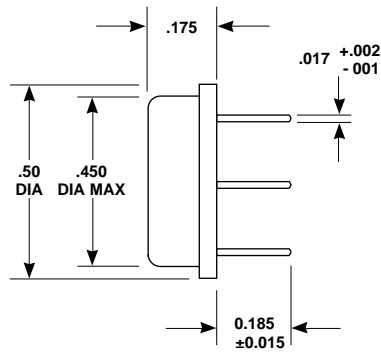
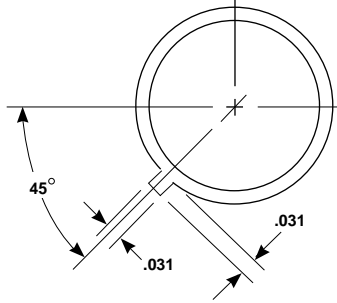

APPROXIMATE WEIGHT 2.1 GRAMS

- NOTES (UNLESS OTHERWISE SPECIFIED):
 1. DIMENSIONS ARE SPECIFIED IN INCHES
 2. TOLERANCES: xx ± .02
 xxx ± .010

Case Drawings TC-1

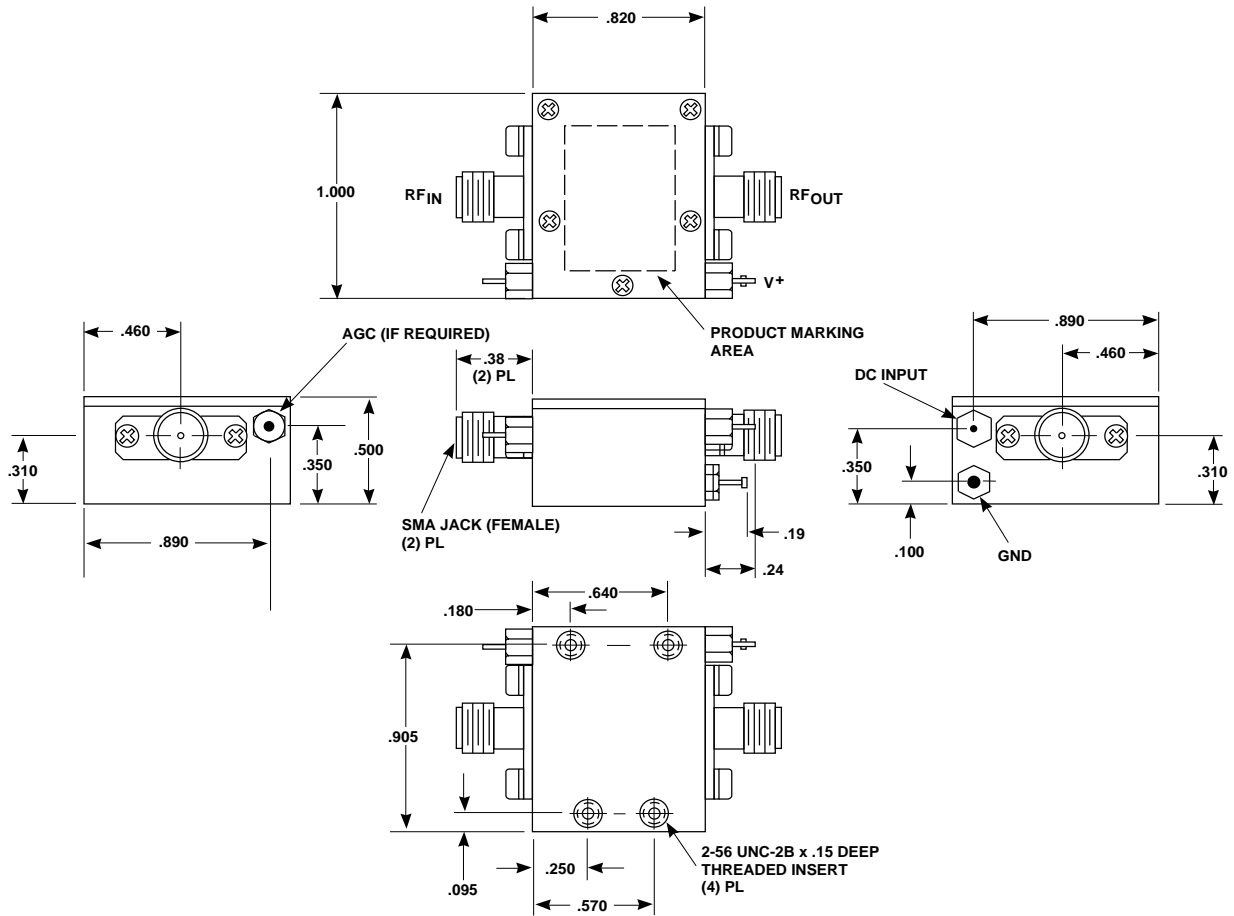

TYPICAL WEIGHT WITH CONNECTORS = 21.5 GRAMS

NOTES: 1. THE TC-1 CASE IS A NON-HERMETIC CASE.
2. THE ONLY CONNECTOR OPTION AVAILABLE FOR THE TC-1 CASE IS THE -1, SMA FEMALE CONNECTORS AT BOTH INPUT AND OUTPUT PORTS.

NOTES (UNLESS OTHERWISE SPECIFIED):
1. DIMENSIONS ARE SPECIFIED IN INCHES
2. TOLERANCES: xx ±.02
xxx ±.010

Contact Teledyne Microwave Solutions:
650-691-9800
650-962-6845 fax

Check for updates:
www.teledynemicrowave.com