

SPECIFICATION

Part No.	:	MA673.A.CGH.004
Product Name	:	Spartan Antenna 3in1 MA673 Low Profile Screw-Mount (Permanent Mount) 3 * 2.4/5GHz MIMO 802.11ac antenna
Features	:	802.11ac compatible IP67 Waterproof High Efficiency / Peak Gain Outdoor Antenna Advanced RF Design and Materials Standard 3M CFD-200 RP-SMA(M) RoHS Compliant

Photo:



1. Introduction

The Spartan MA673 2.4 / 4.9~5.8GHz 3*MIMO antenna is a low profile, heavy-duty, fully IP67 waterproof external antenna for use in 802.11ac high data throughput and video broadcast applications.

The Spartan is unique in the market because it combines three 2.4 / 4.9~5.8GHz antenna elements in a heavy-duty antenna with high efficiency in a low profile and high quality aesthetic styled housing. The antenna screws down permanently onto a roof or metal panel and can be pole or wall-mounted.

Care has been taken to optimize the isolation at more than 20dB from any one antenna to the other, and radiation patterns are distinct allowing for greater de-correlation, vital factors for optimization of MIMO system efficiency.

For industries such as remote monitoring, smart meter systems, construction equipment, public safety at only 40mm high, the Spartan provides an unobtrusive, robust, rugged antenna that is durable even in extreme environments. This specification shows the true performance including 3 meters of cable loss. If cable is shorter antenna performance will increase even more.

2. Specification

ELECTRICAL									
Frequency (MHz)		2400MHz	2450MHz	2500MHz	4900MHz	5150MHz	5350MHz	5725MHz	5850MHz
Efficiency (%)									
2.4/5GHz MIMO 1	1M	66.38	72.74	71.97	42.13	57.11	57.50	60.02	48.22
	2M	57.82	63.35	62.68	34.24	46.42	46.74	48.79	38.31
	3M	50.36	53.92	53.35	28.48	37.73	37.99	38.75	31.14
	5M	39.09	41.86	40.47	18.82	24.93	25.10	25.02	20.10
2.4/5GHz MIMO 2	1M	43.38	45.94	42.44	46.39	50.96	49.13	54.72	49.65
	2M	37.78	40.01	36.96	37.71	41.42	39.94	44.48	39.44
	3M	32.91	34.06	31.46	31.37	33.67	32.46	35.33	32.06
	5M	25.54	26.44	23.86	20.72	22.25	21.45	22.81	20.70
2.4/5GHz MIMO 3	1M	50.96	60.66	51.48	31.84	62.67	58.42	35.87	34.80
	2M	44.38	52.83	44.83	25.88	50.94	47.49	29.16	27.64
	3M	38.66	44.97	38.16	21.53	41.41	38.60	23.16	22.47
	5M	30.01	34.91	28.95	14.22	27.36	25.50	14.95	14.51
Average Gain(dBi)									
2.4/5GHz MIMO 1	1M	-1.78	-1.38	-1.43	-3.75	-2.43	-2.40	-2.22	-3.17
	2M	-2.38	-1.98	-2.03	-4.65	-3.33	-3.30	-3.12	-4.17
	3M	-2.98	-2.68	-2.73	-5.45	-4.23	-4.20	-4.12	-5.07
	5M	-4.08	-3.78	-3.93	-7.25	-6.03	-6.00	-6.02	-6.97
2.4/5GHz MIMO 2	1M	-3.63	-3.38	-3.72	-3.34	-2.93	-3.09	-2.62	-3.04
	2M	-4.23	-3.98	-4.32	-4.24	-3.83	-3.99	-3.52	-4.04
	3M	-4.42	-4.68	-5.02	-5.04	-4.73	-4.89	-4.52	-4.94
	5M	-5.93	-5.78	-6.22	-6.84	-6.53	-6.69	-6.42	-6.84
2.4/5GHz MIMO 3	1M	-2.93	-2.17	-2.88	-4.97	-2.03	-2.33	-4.45	-4.58
	2M	-3.53	-2.77	-3.48	-5.87	-2.93	-3.23	-5.35	-5.58
	3M	-4.13	-3.47	-4.18	-6.67	-3.83	-4.13	-6.35	-6.48
	5M	-5.23	-4.57	-5.38	-8.47	-5.63	-7.13	-8.25	-8.38
Peak Gain(dBi)									
2.4/5GHz MIMO 1	1M	2.33	3.04	3.27	3.51	5.00	4.86	5.11	3.69
	2M	1.73	2.44	2.67	2.61	4.10	3.96	4.21	2.69
	3M	1.13	1.74	1.97	1.81	3.20	3.06	3.21	1.79
	5M	0.03	0.64	0.77	0.01	1.40	1.26	1.31	-0.11
2.4/5GHz MIMO 2	1M	2.47	2.38	1.84	3.48	3.16	2.46	3.50	3.66
	2M	1.87	1.78	1.24	2.58	2.26	1.56	2.60	2.66
	3M	1.60	1.08	0.54	1.78	1.36	0.66	1.60	1.76
	5M	0.17	-0.02	-0.66	-0.02	-0.44	-1.14	-0.30	-0.14
2.4/5GHz MIMO 3	1M	3.66	4.11	3.42	3.17	5.64	4.79	3.29	3.33
	2M	3.06	3.51	2.82	2.27	4.74	3.89	2.39	2.33
	3M	2.92	2.81	2.12	1.47	3.84	2.99	1.39	1.43
	5M	1.36	1.71	0.92	-0.33	2.04	25.50	-0.51	-0.47
Impedance					50Ω				
Polarization					Linear				
Radiation Pattern					Omni				
Input Power					5 W				

MECHANICAL	
Antenna Dimensions	Height 65.35mm x Diameter 147.5mm
Casing	Wonderloy PC-540
Base and thread	CAN10 Zinc Alloy
Waterproof	IP67
Thread diameter	M30 x 2 Thread 32L
Nut	Nickel Plated Steel
Foam	CR-4305
3M Adhesive	3M 9448 HK
Cable	CFD-200 Low Loss Coaxial Cable
Cable length	3 meters, fully customizable
Connector	RP-SMA(M) ST, fully customizable
Weight(Antenna unpackaged)	0.908kg
Weight(Antenna Individual Box)	1.078kg
Recommended Torque for Mounting	49N·m
Max Torque for Mounting	58.8N·m
ENVIRONMENTAL	
Operation Temperature	-30°C to 85°C
Storage Temperature	-40°C to 90°C
Humidity	Non-condensing 65°C 95% RH

3. Antenna Characteristics

3.1 Testing setup

MA.673 antenna was tested with R&S ZNB-8 network analyzer.



In free space

3.2 Return Loss and Isolation

3.2.1 with 1M coaxial cable

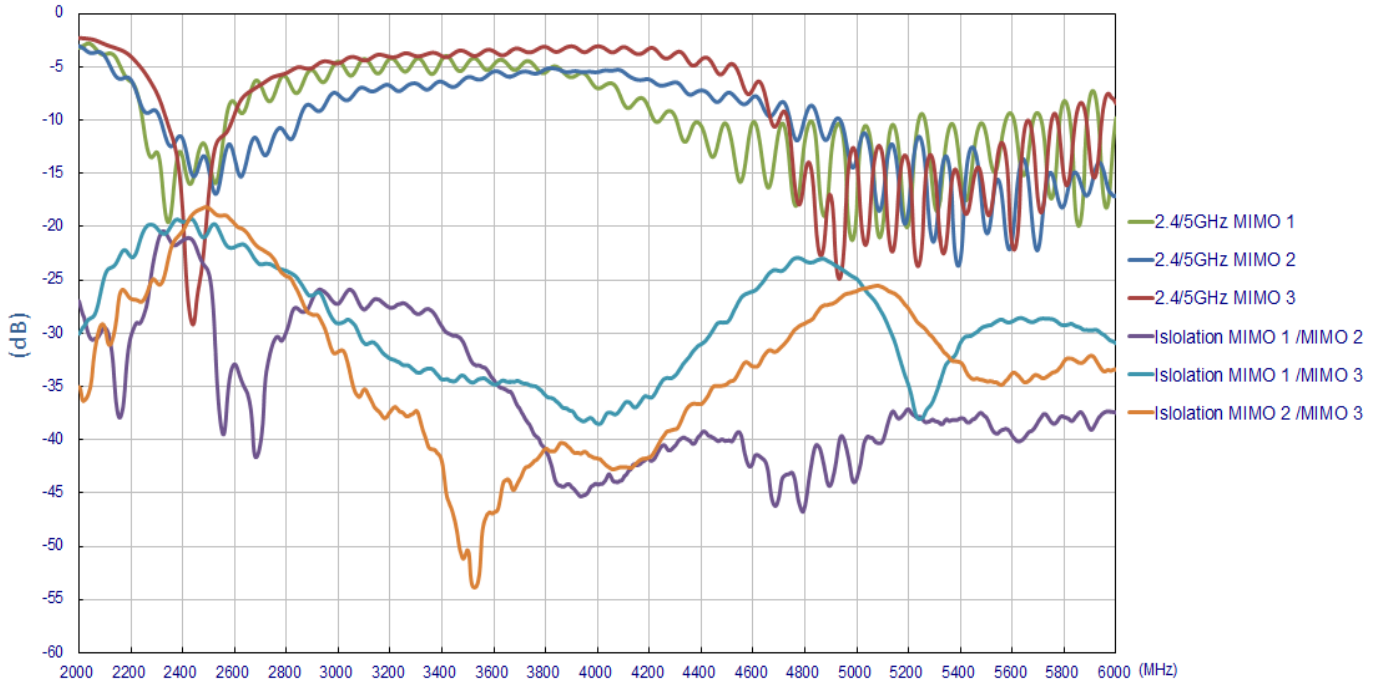

3.2.2 with 2M coaxial cable

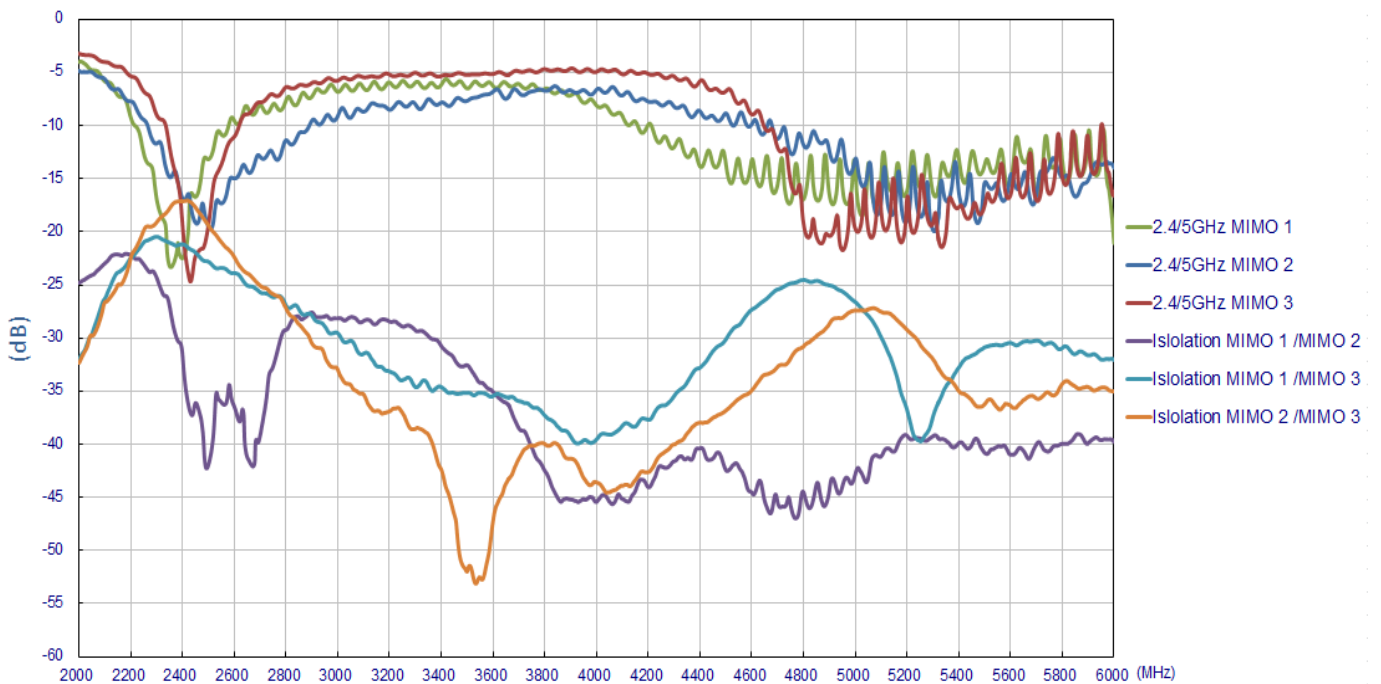

3.2.3 with 3M coaxial cable

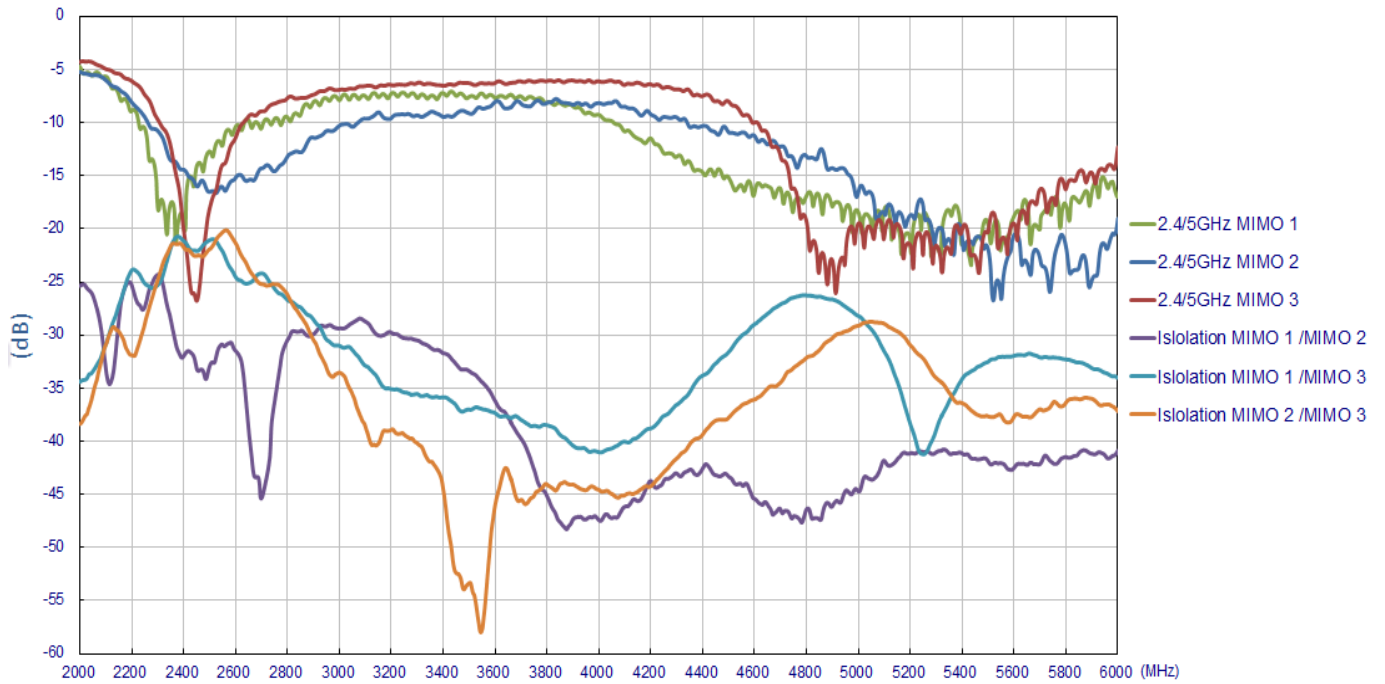

3.2.4 with 5M coaxial cable

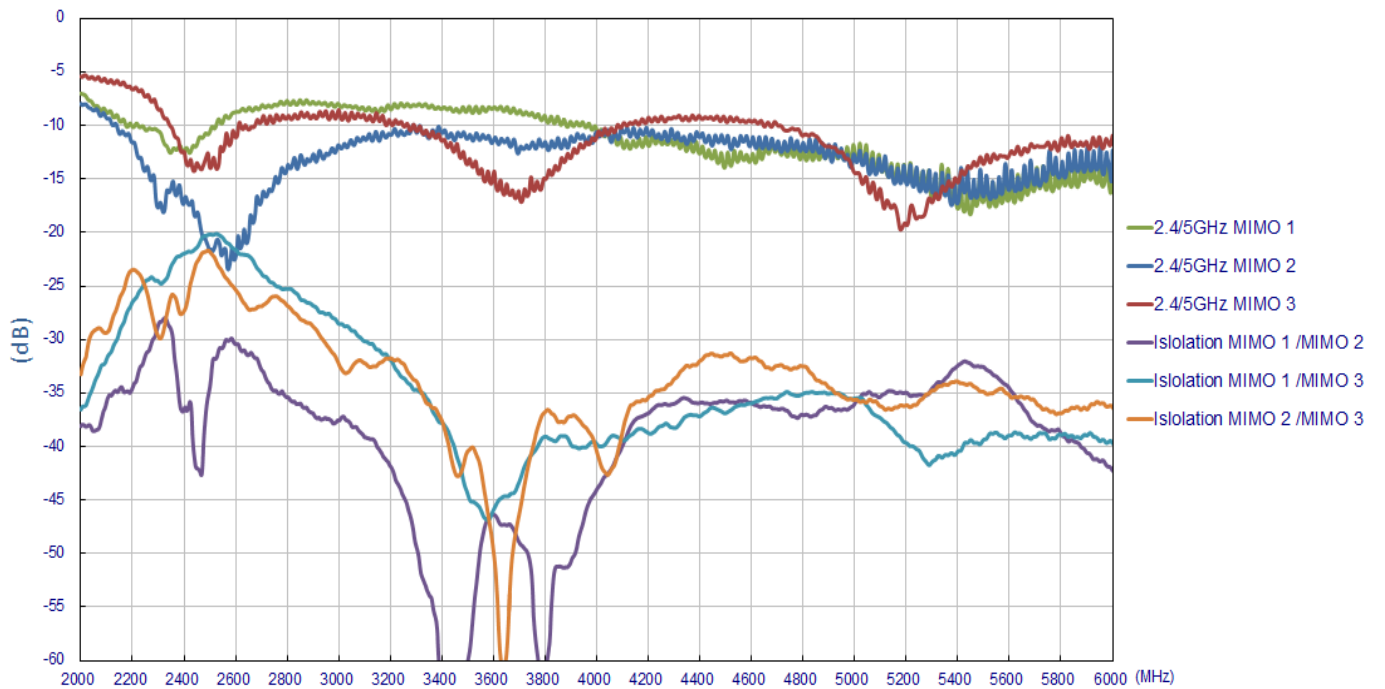

3.3 Efficiency

3.3.1 with 1M coaxial cable

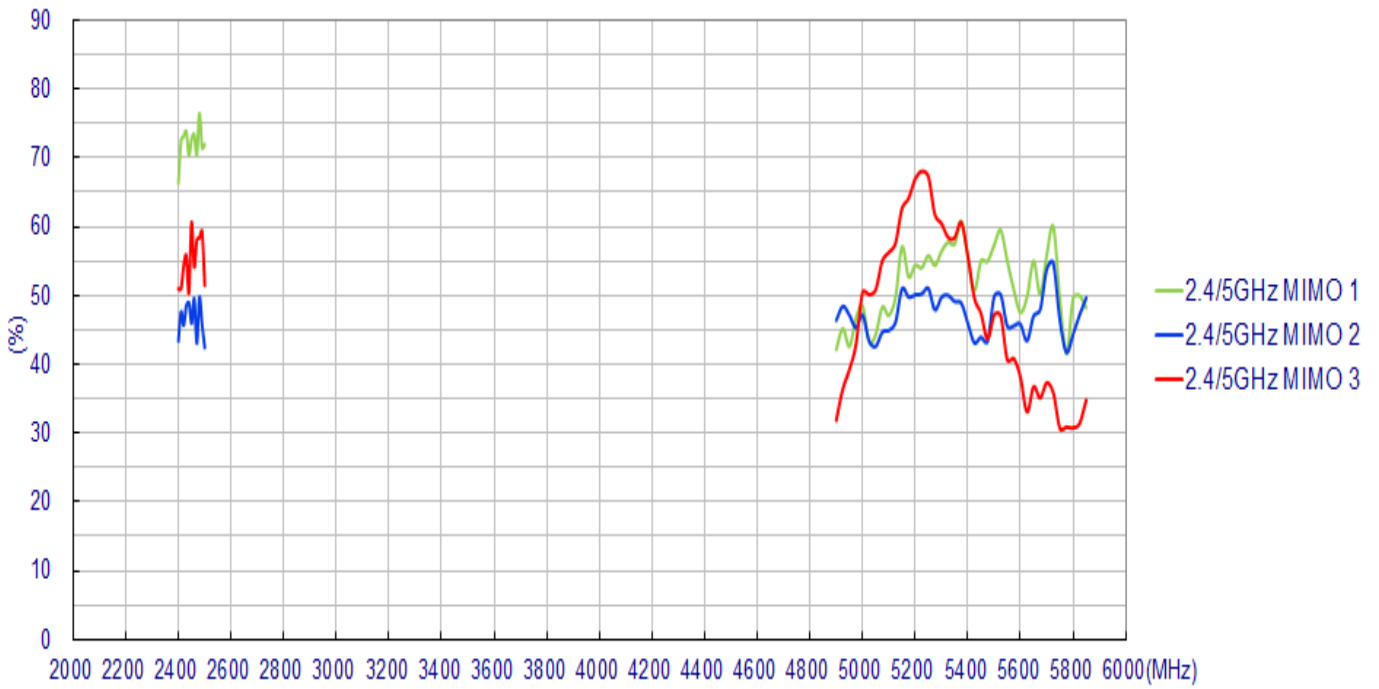

3.3.2 with 2M coaxial cable

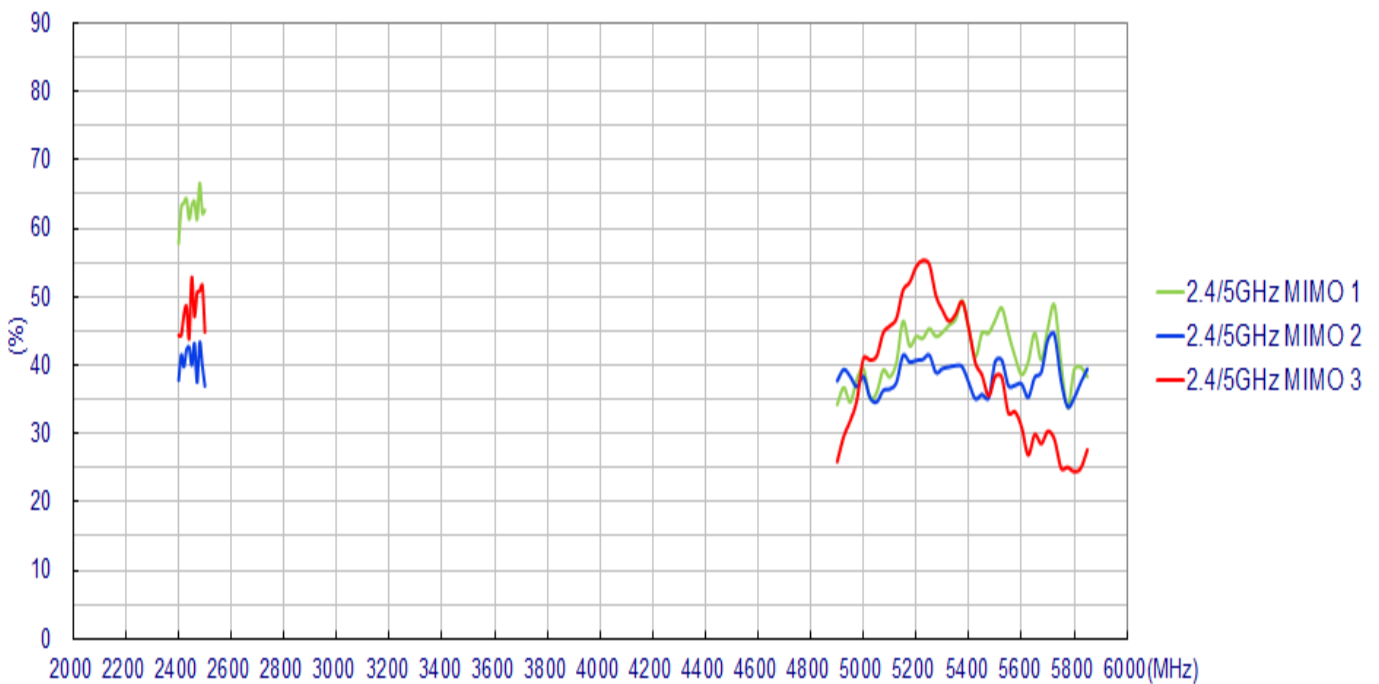

3.3.3 with 3M coaxial cable

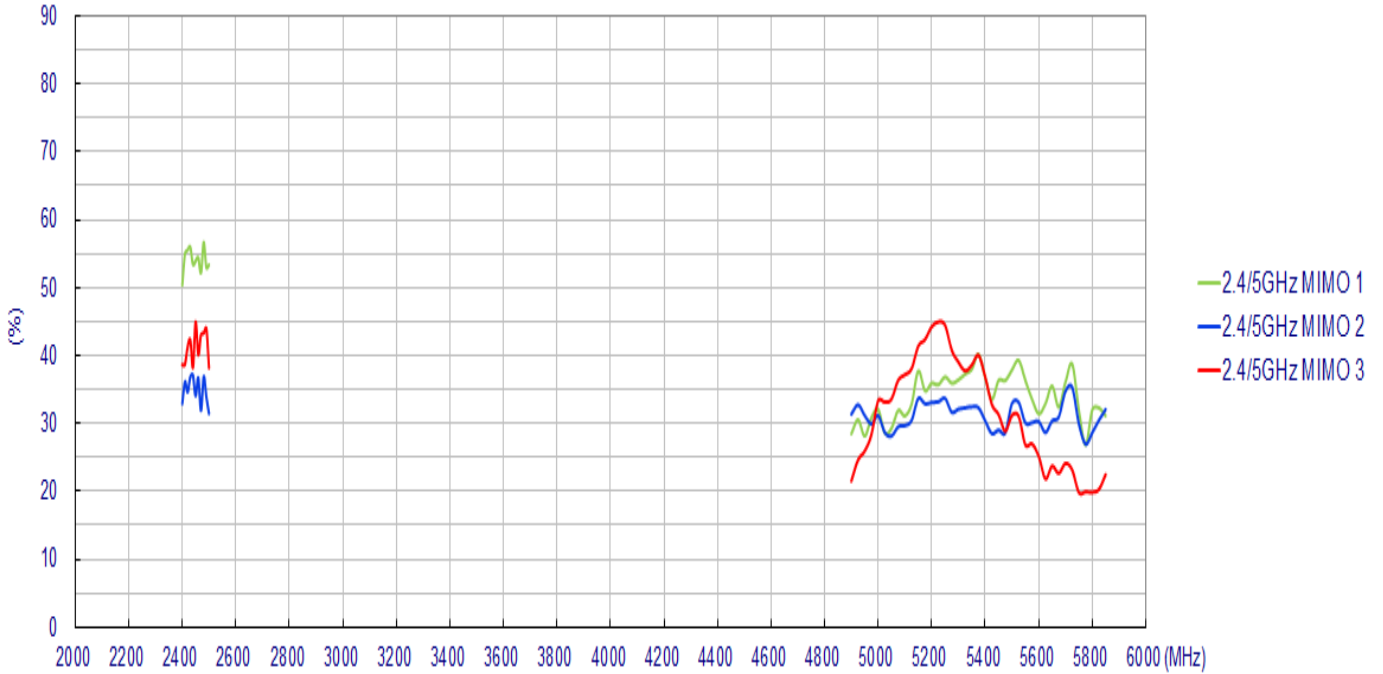

3.3.4 with 5M coaxial cable

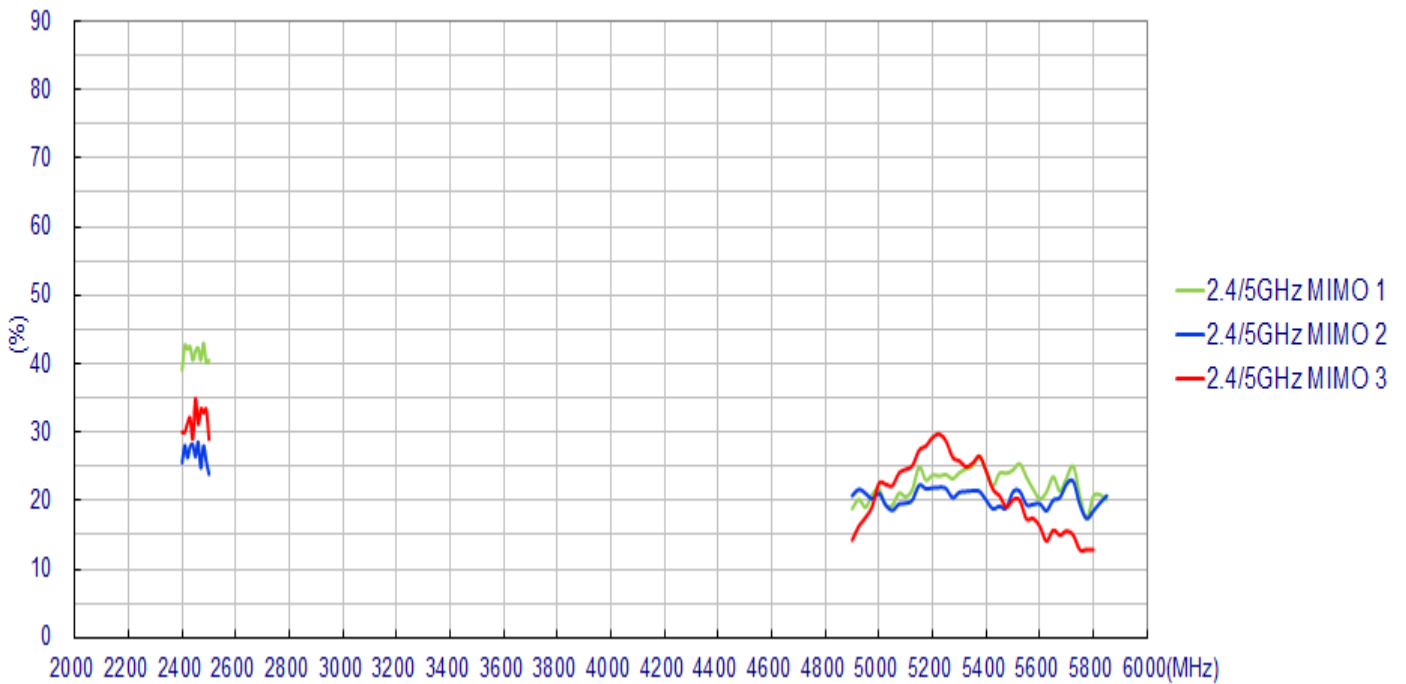

3.4 Peak Gain

3.4.1 with 1M coaxial cable

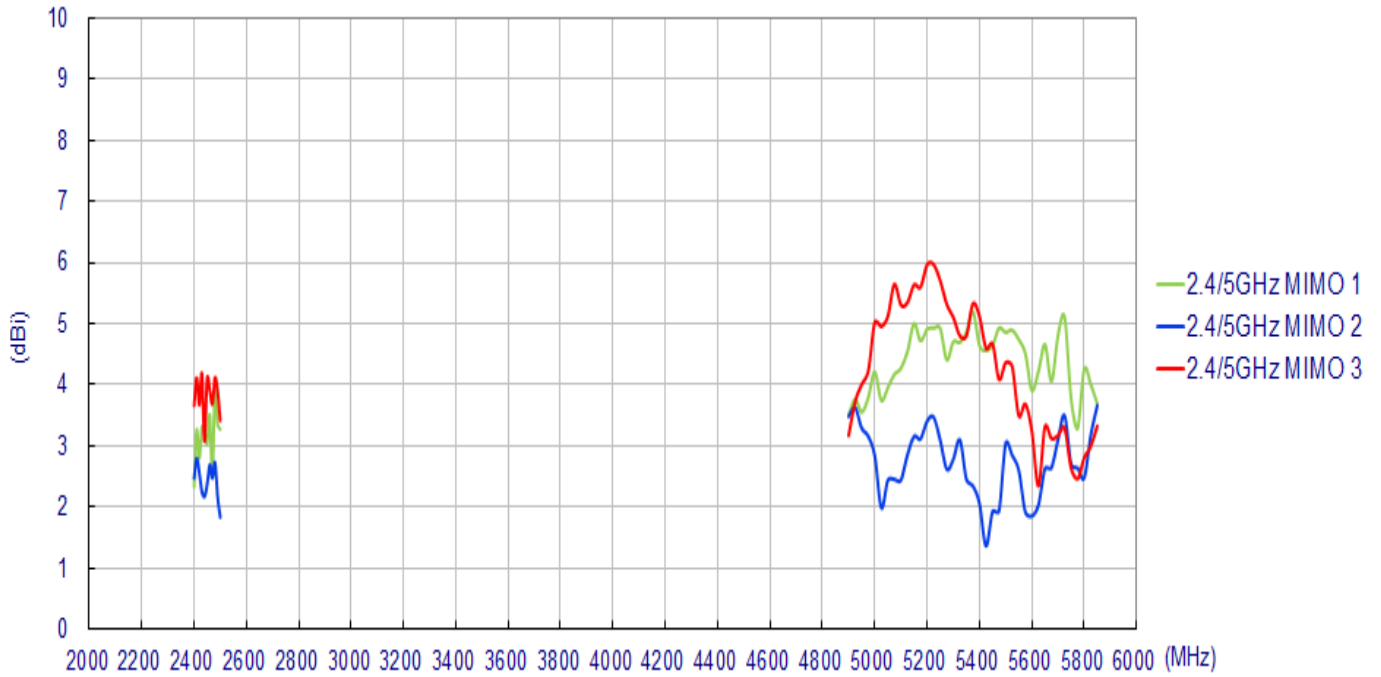

3.4.2 with 2M coaxial cable

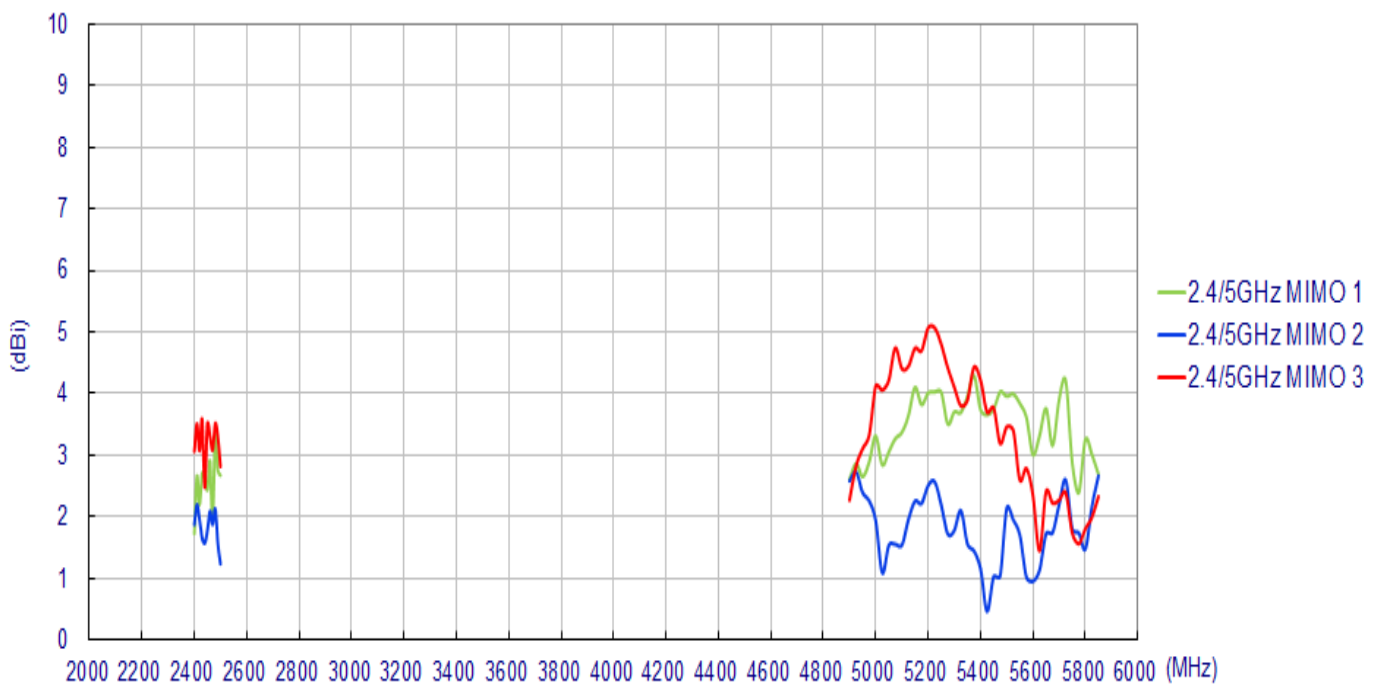

3.4.3 with 3M coaxial cable

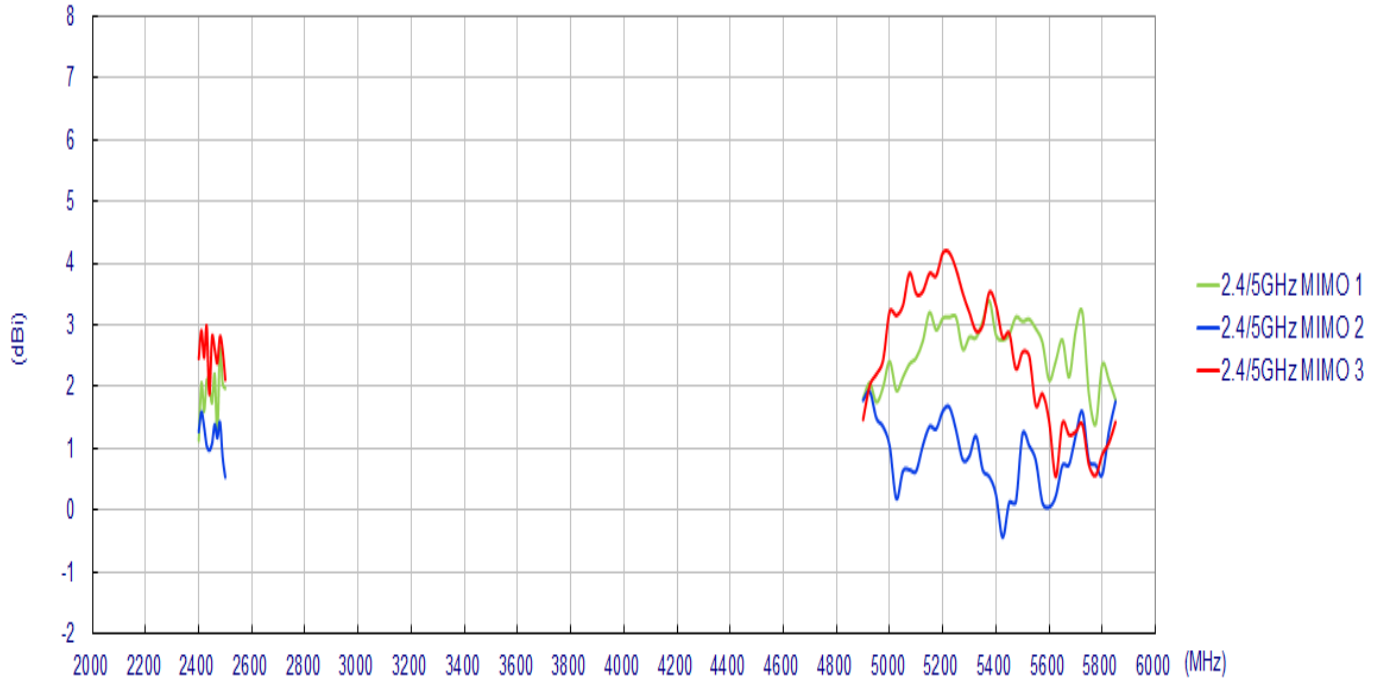

3.4.4 with 5M coaxial cable

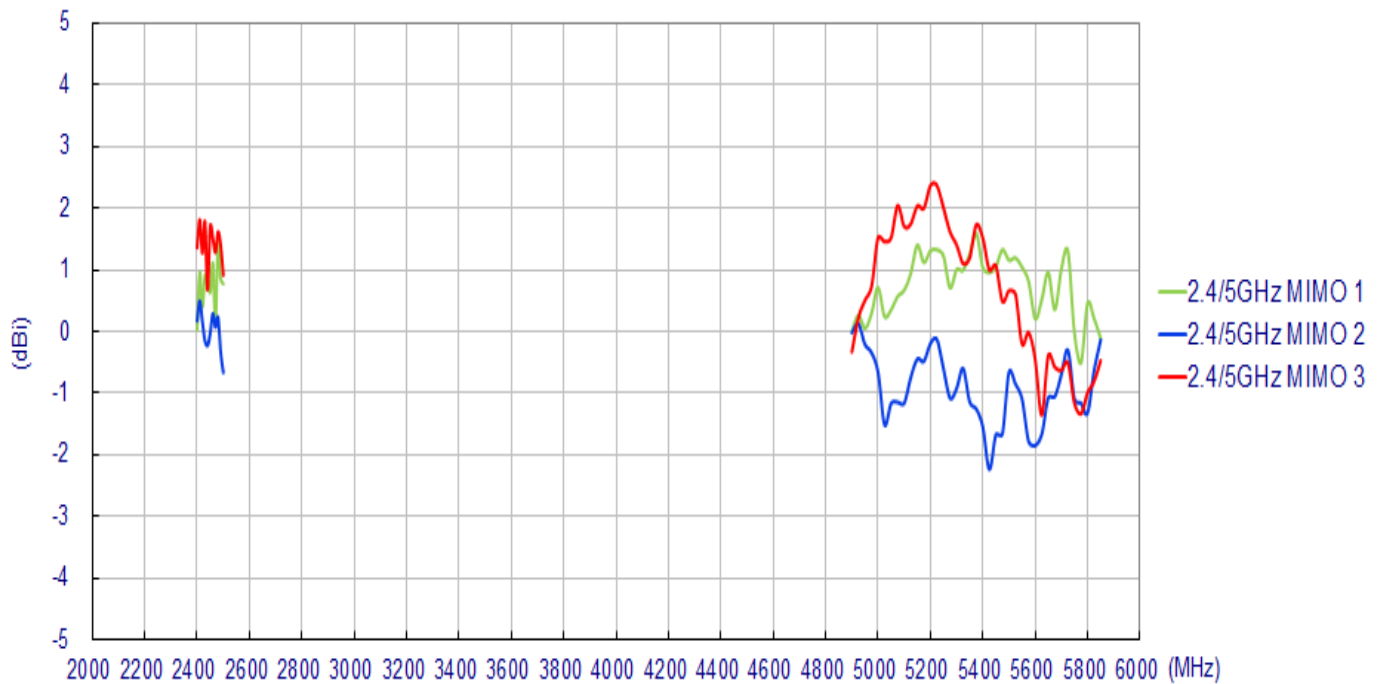

3.5 Average Gain

3.5.1 with 1M coaxial cable

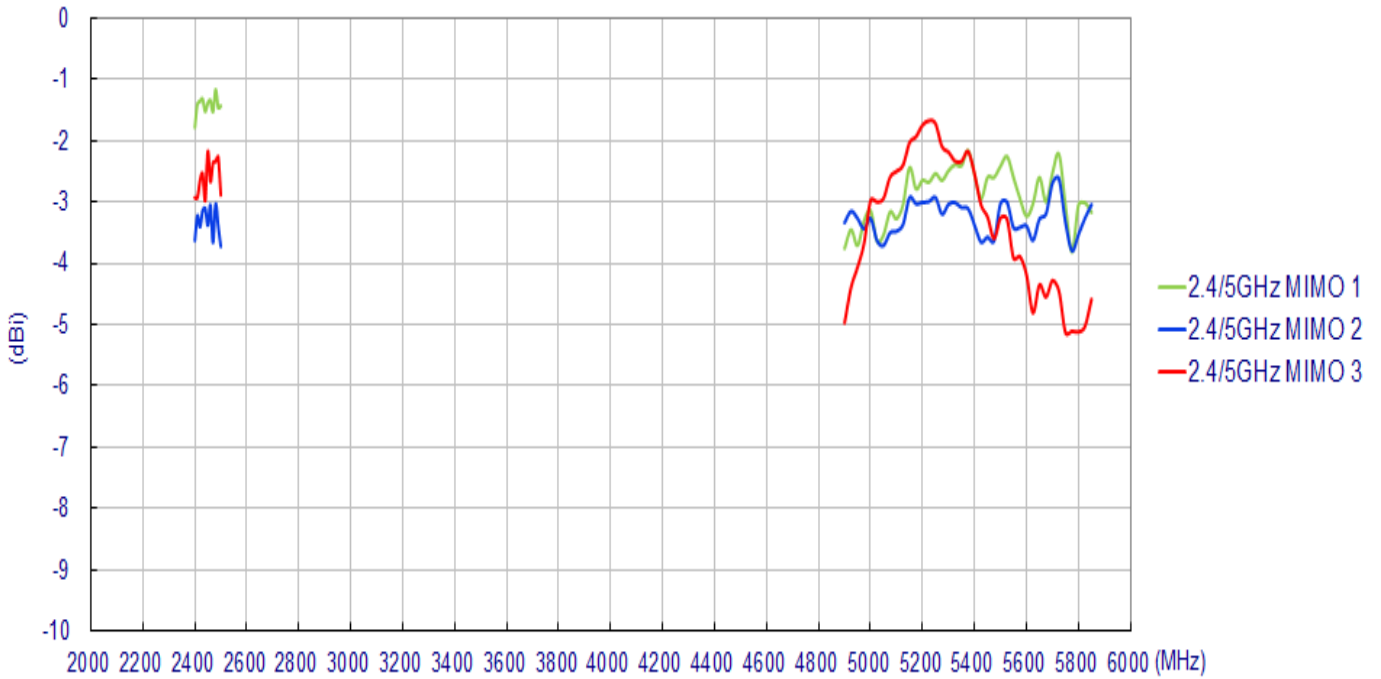

3.5.2 with 2M coaxial cable

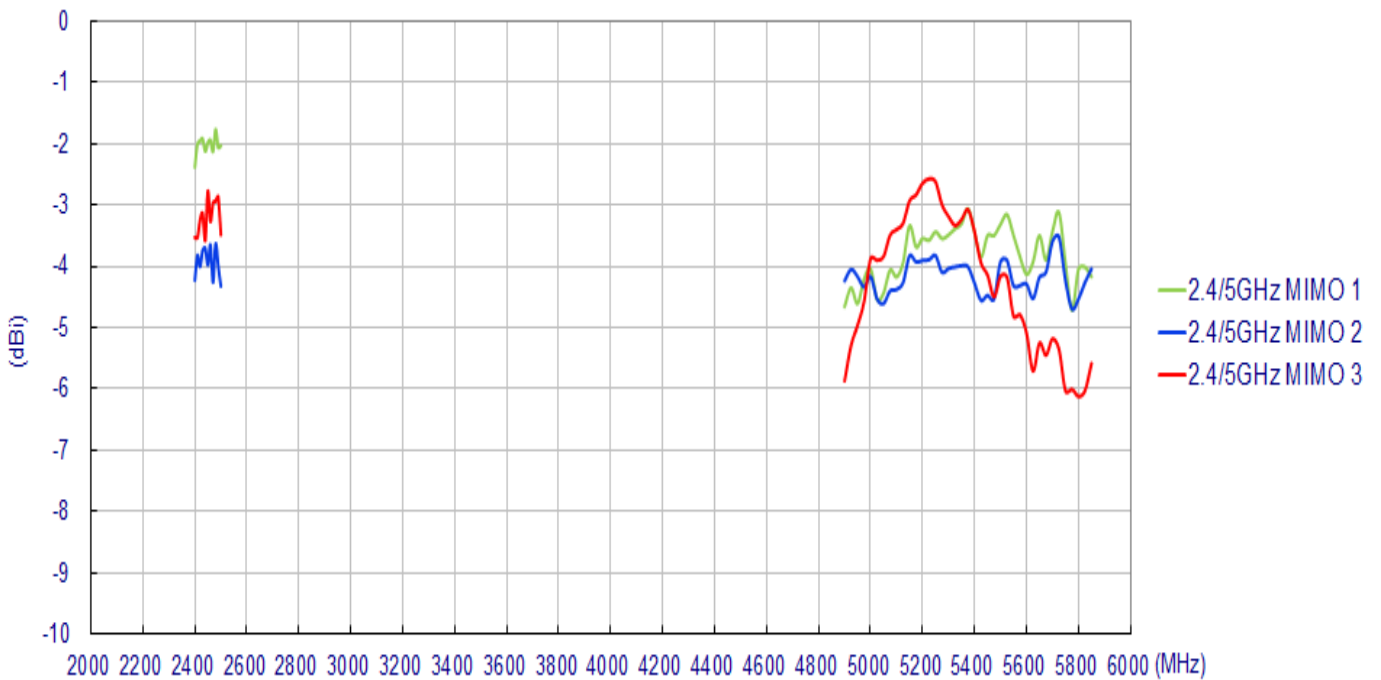

3.5.3 with 3M coaxial cable

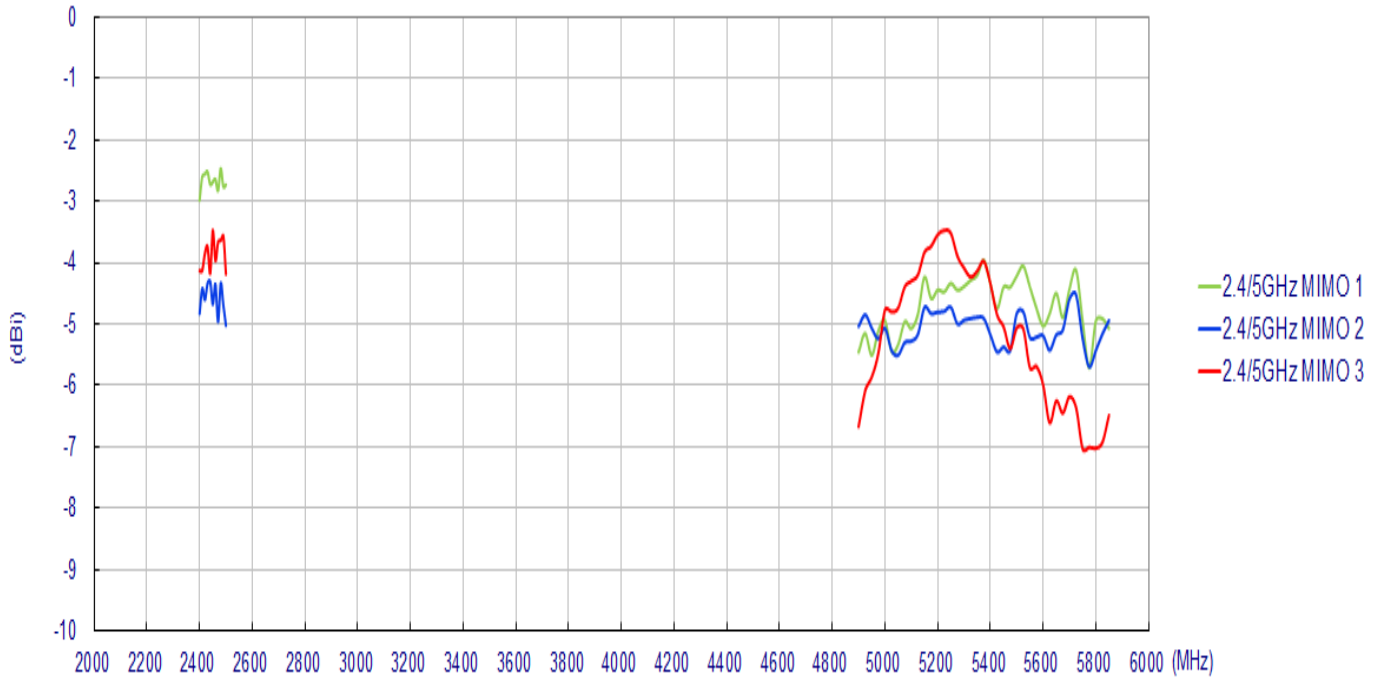

3.5.4 with 5M coaxial cable

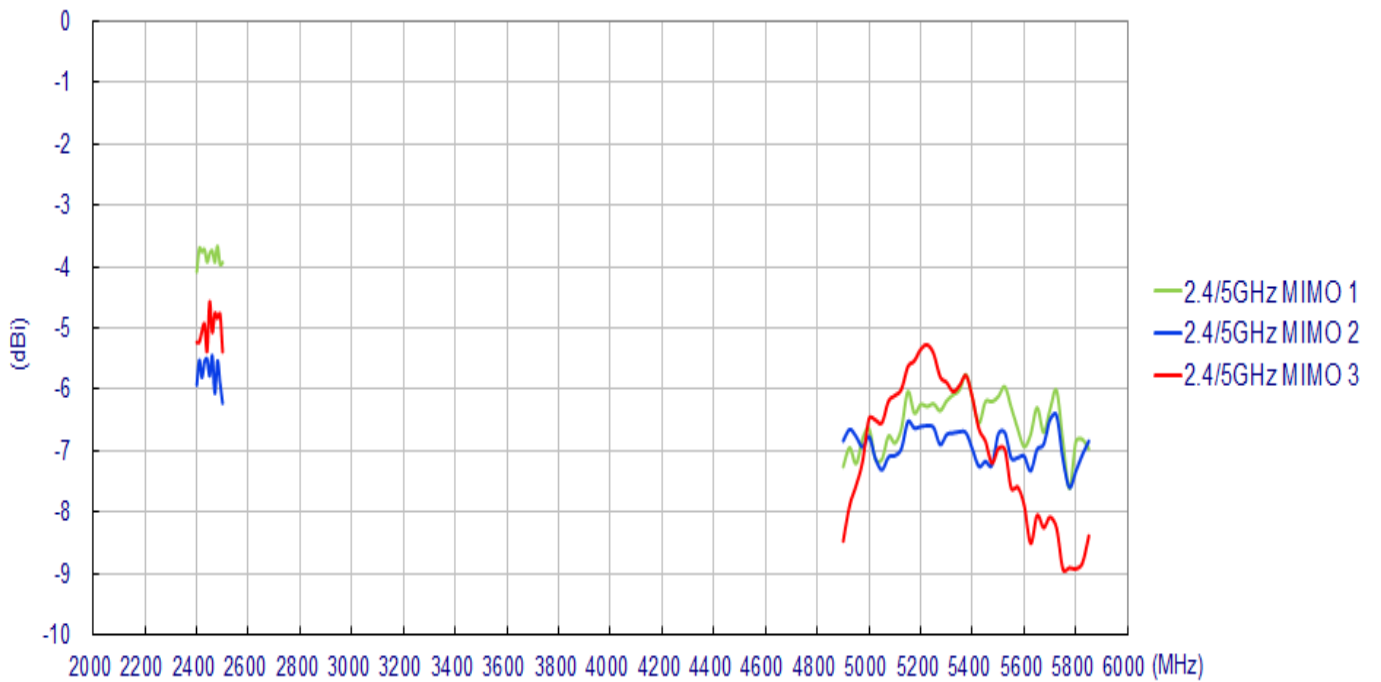

4. Antenna Radiation Patterns

4.1 Antenna setup

The antenna radiation pattern measured setup as shown the below, (with 3 meters cable length)

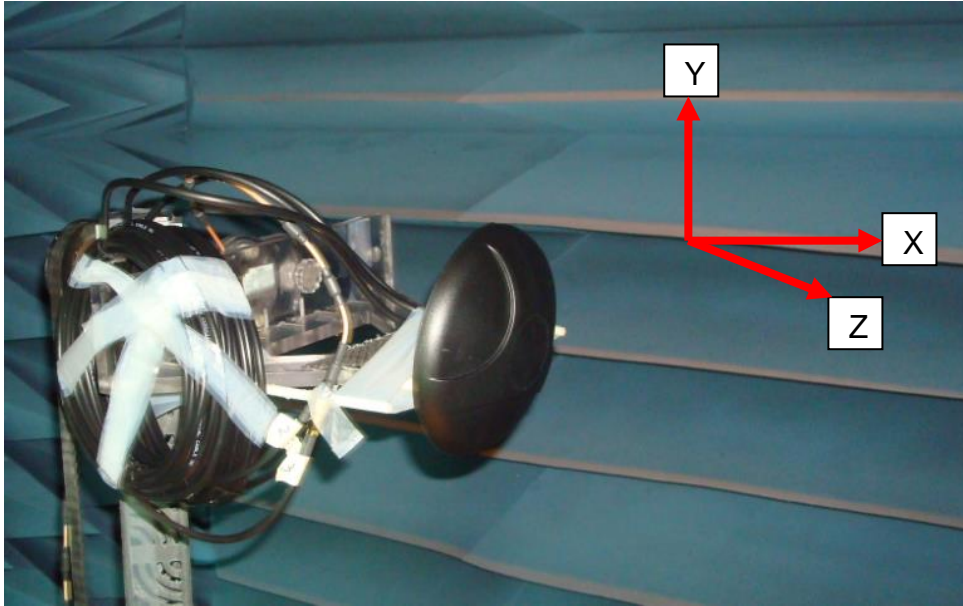

In free space

4.2 Antenna radiation patterns

2.4/5GHz MIMO 1

XY Plane

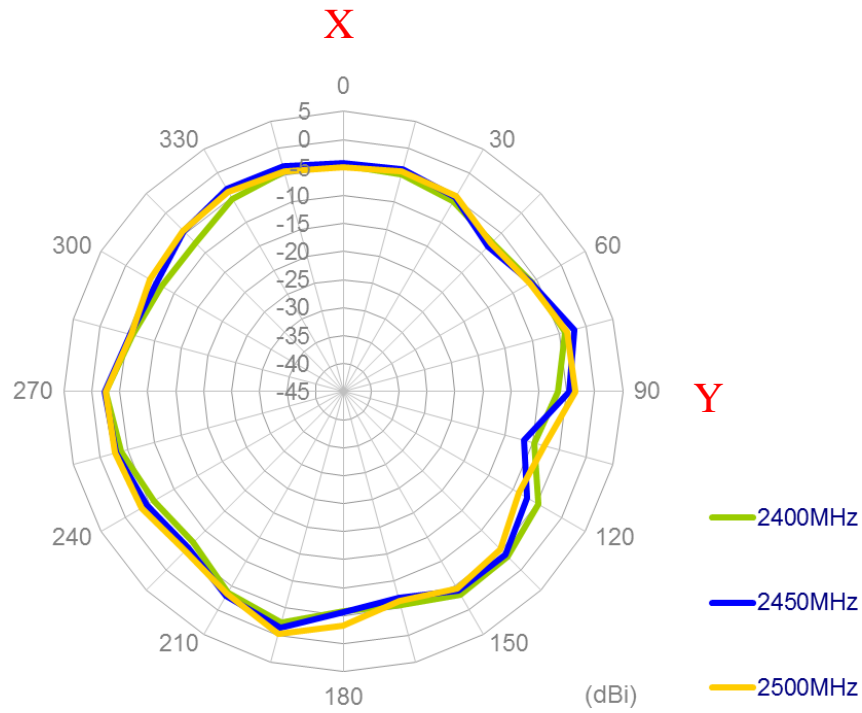

XZ Plane

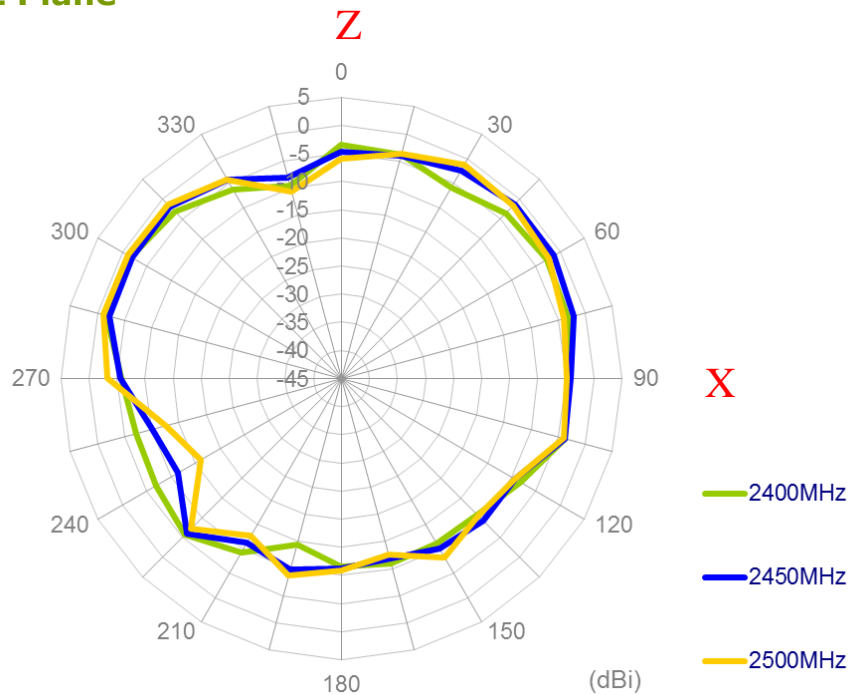

YZ Plane

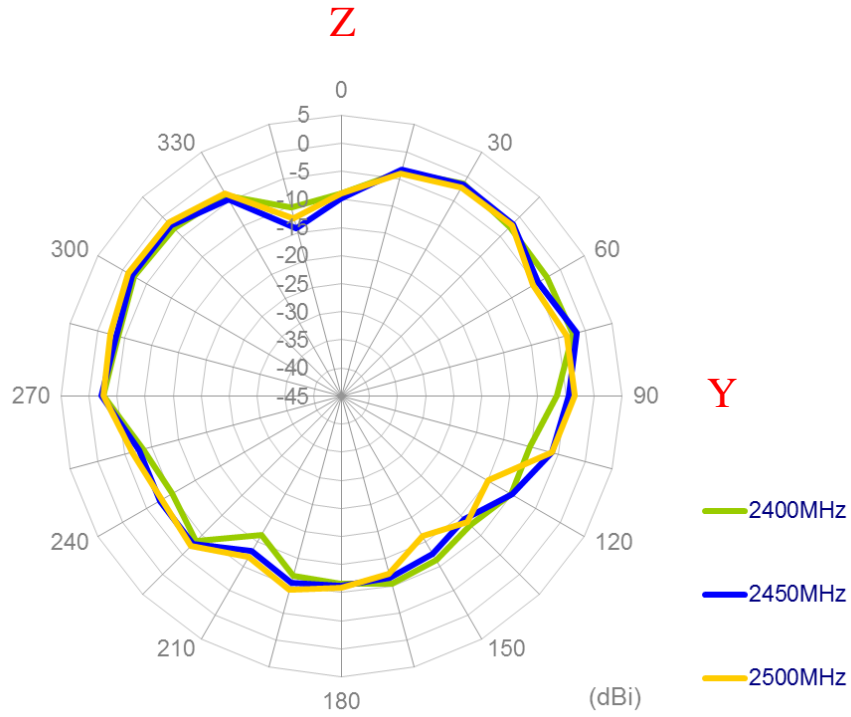

XY Plane

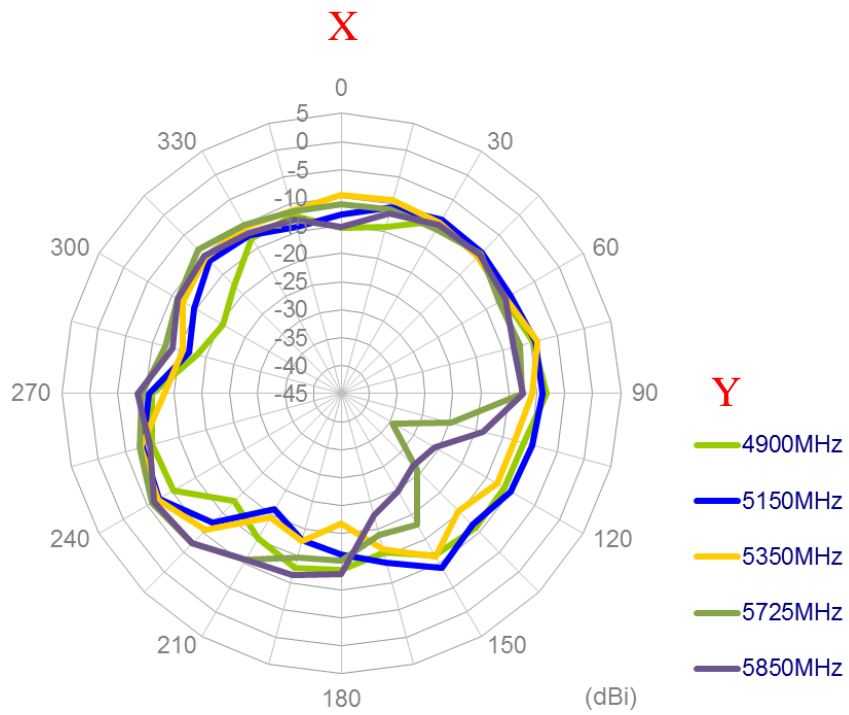

XZ Plane

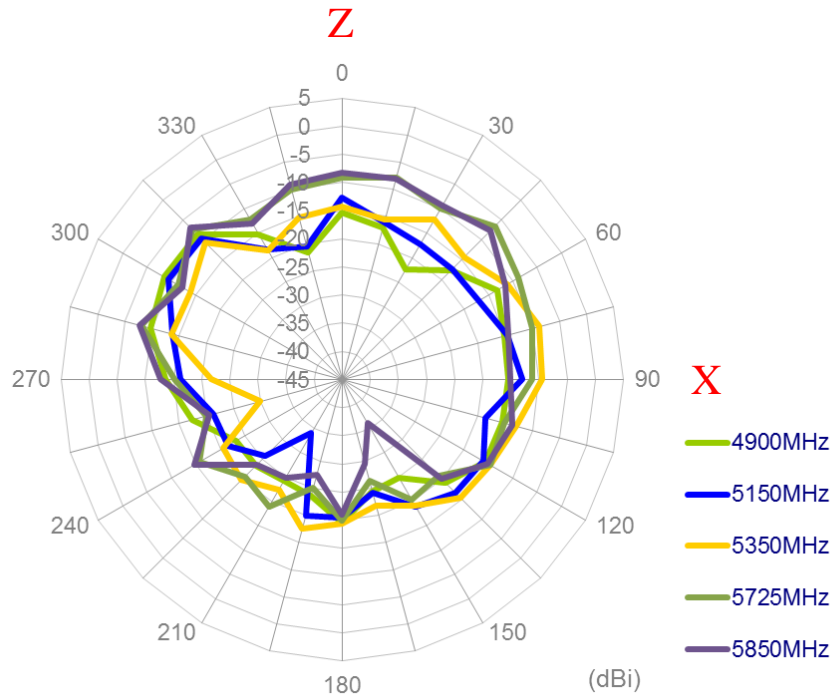

YZ Plane

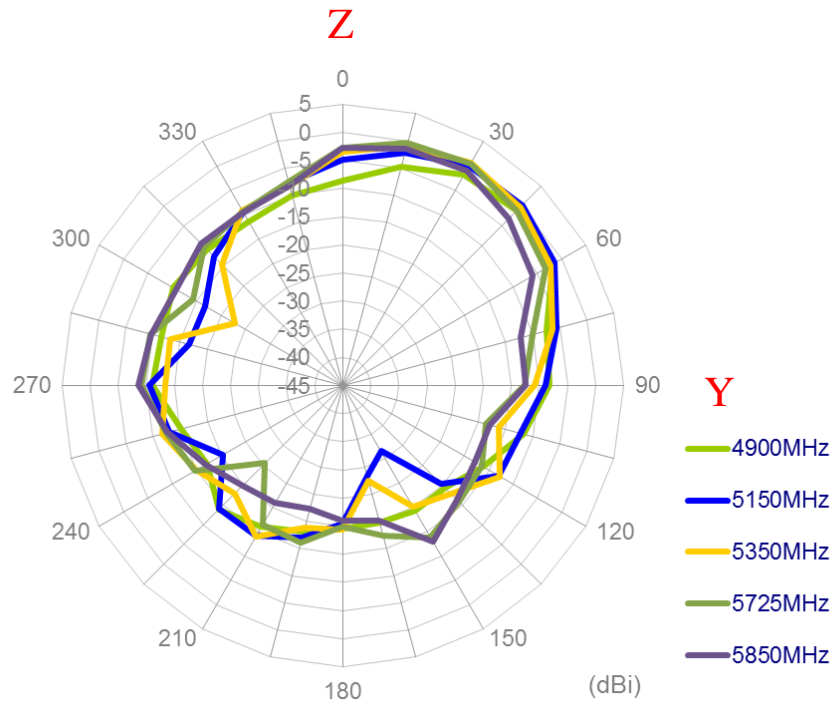

2.4/5GHz MIMO 2
XY Plane

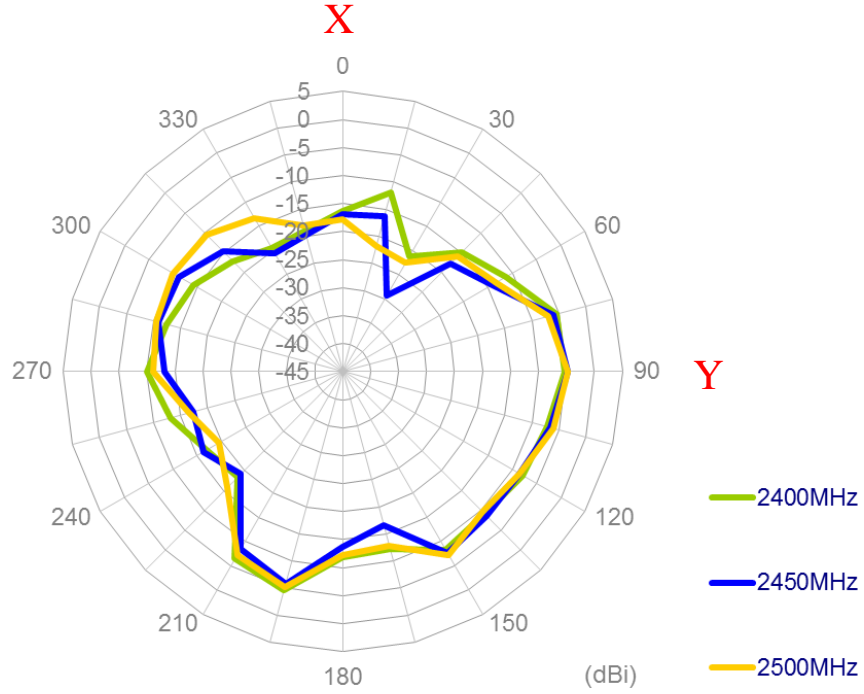

XZ Plane

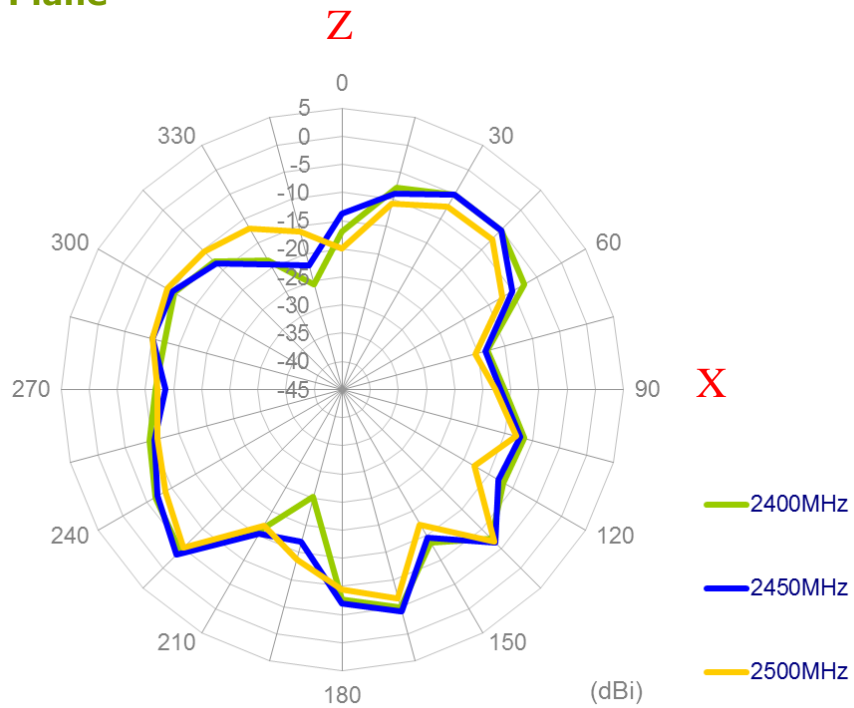

YZ Plane

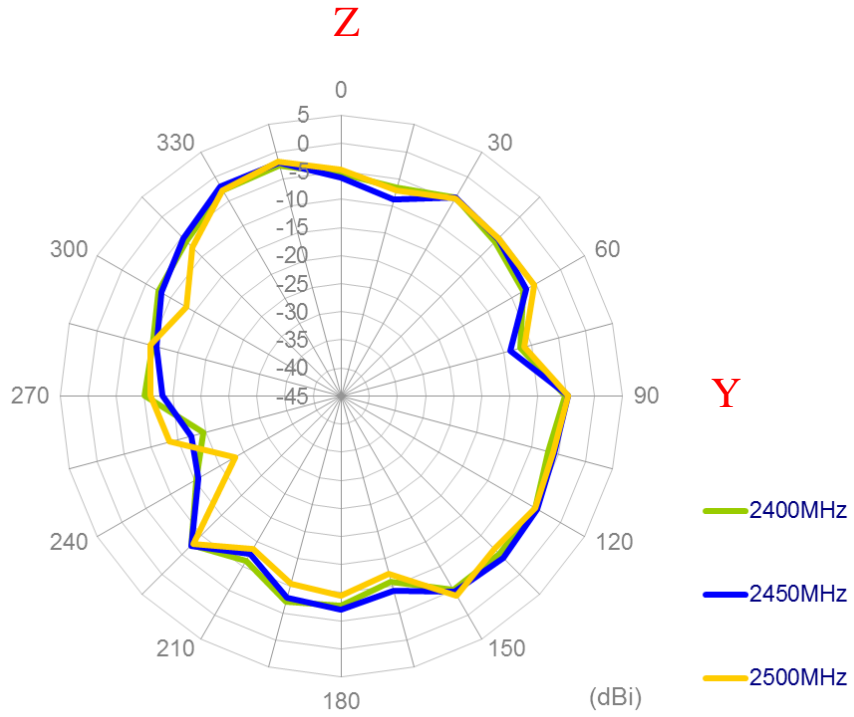

XY Plane

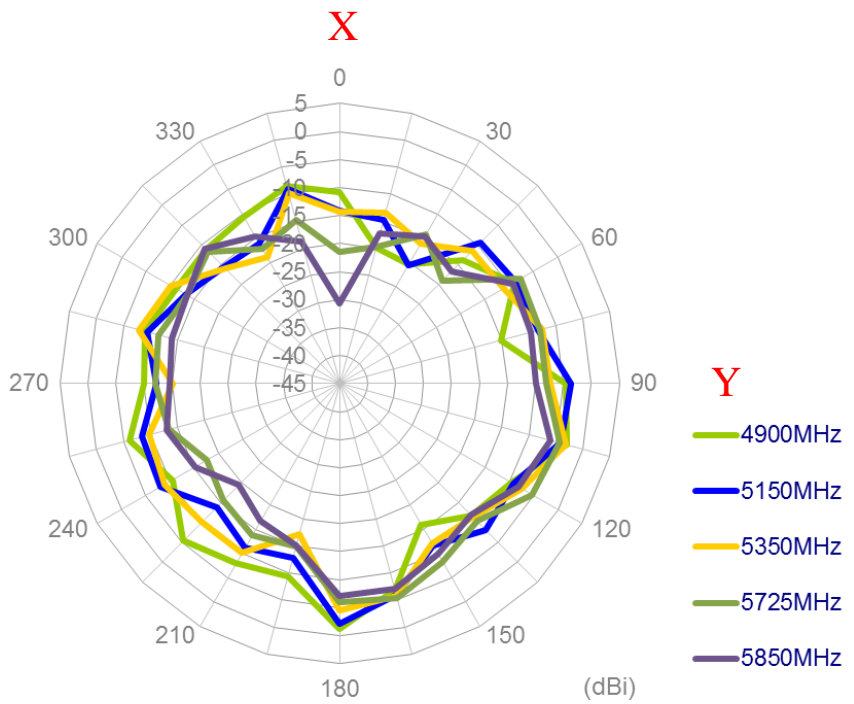

XZ Plane

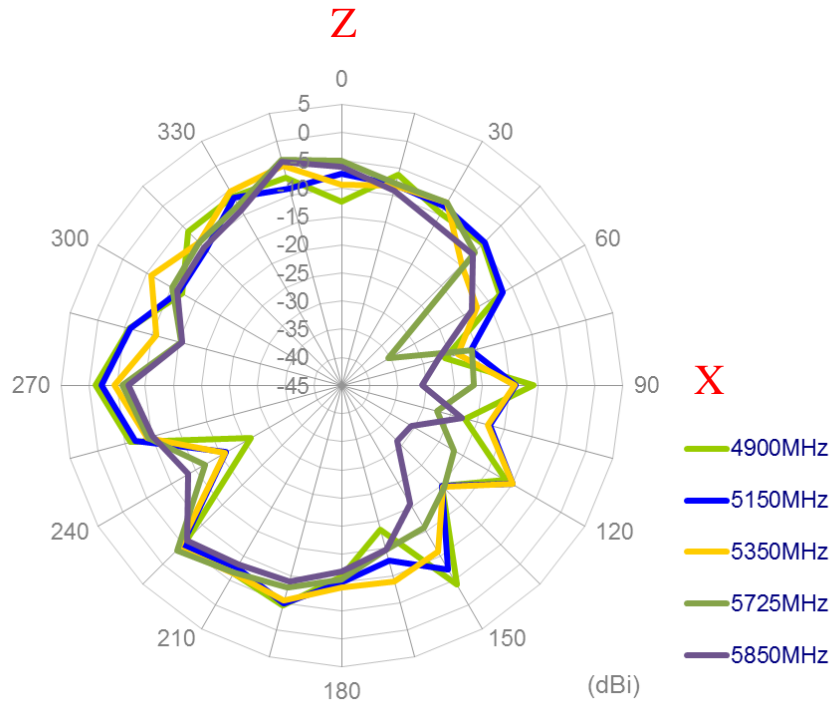

YZ Plane

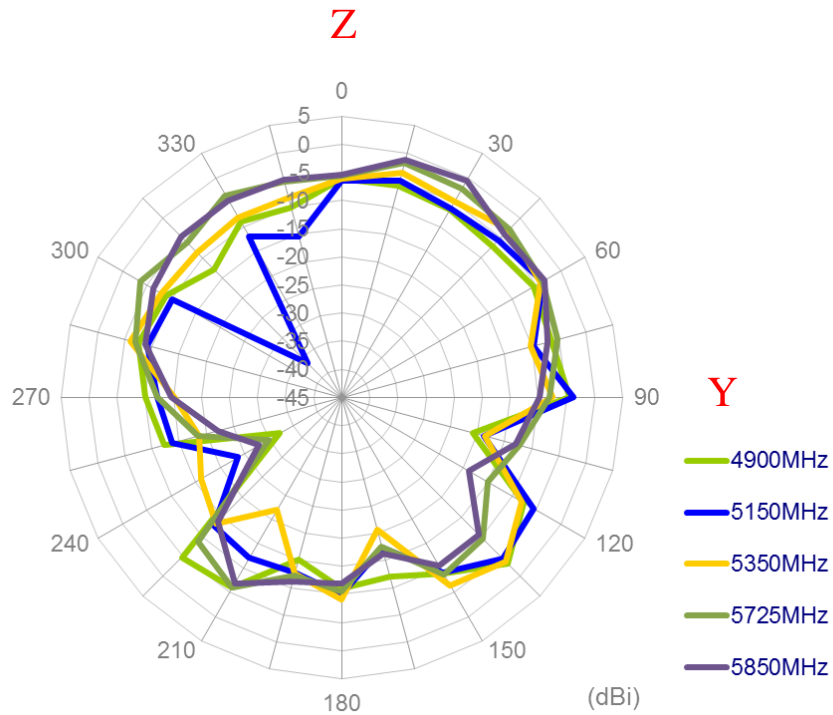

**2.4/5GHz MIMO 3
XY Plane**

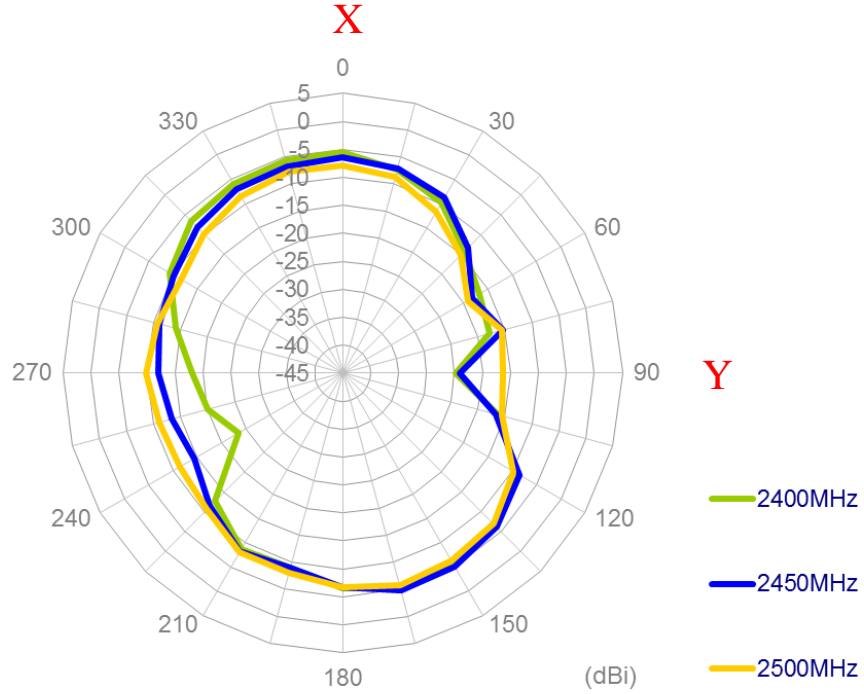

XZ Plane

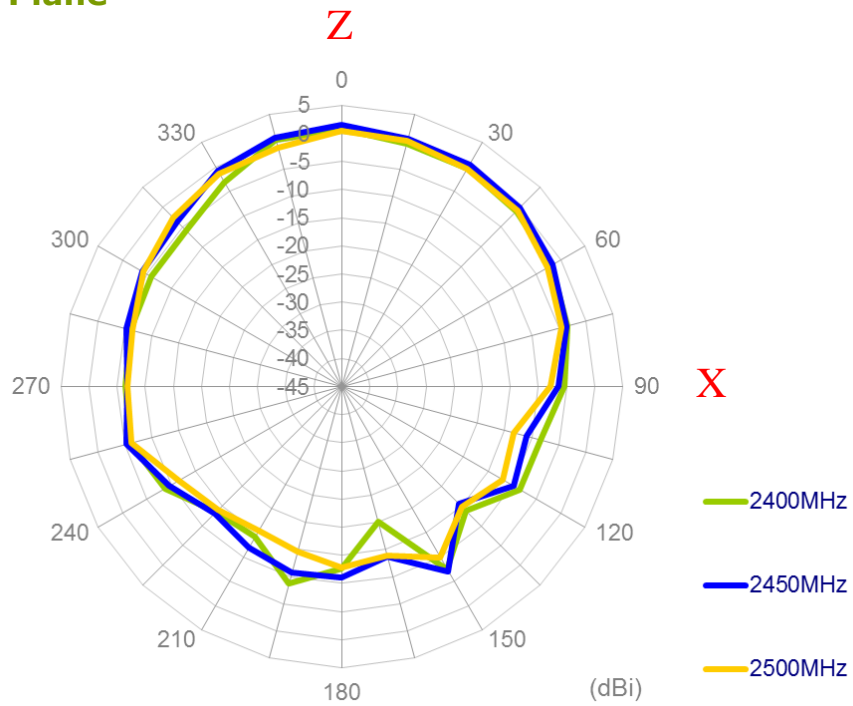

YZ Plane

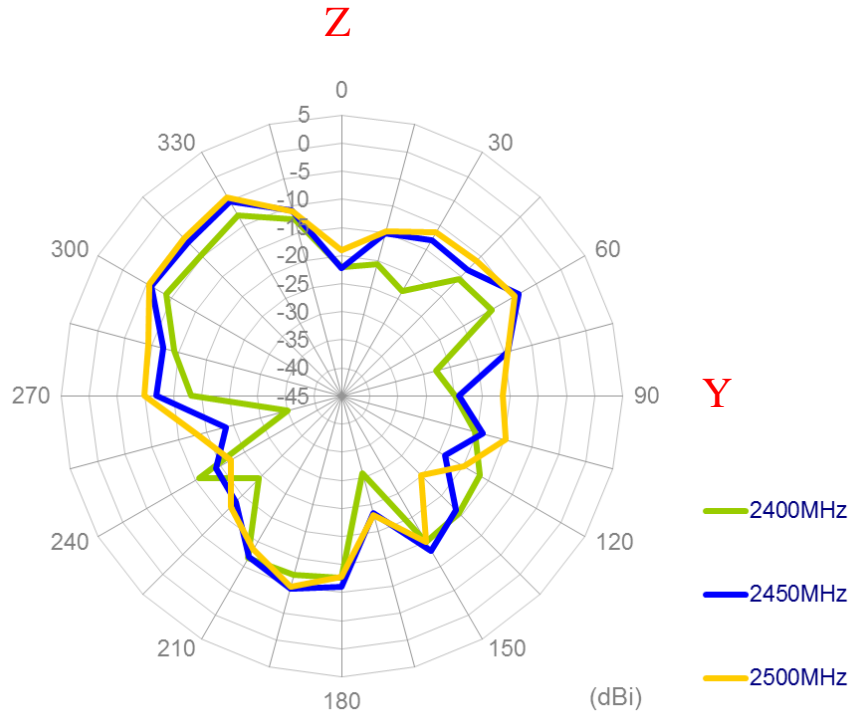

XY Plane

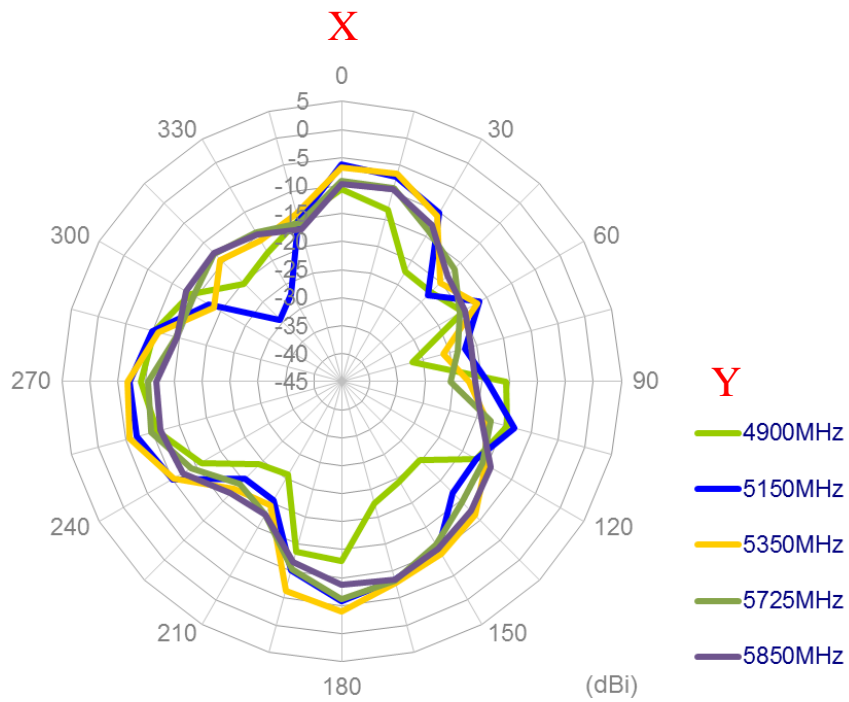

XZ Plane

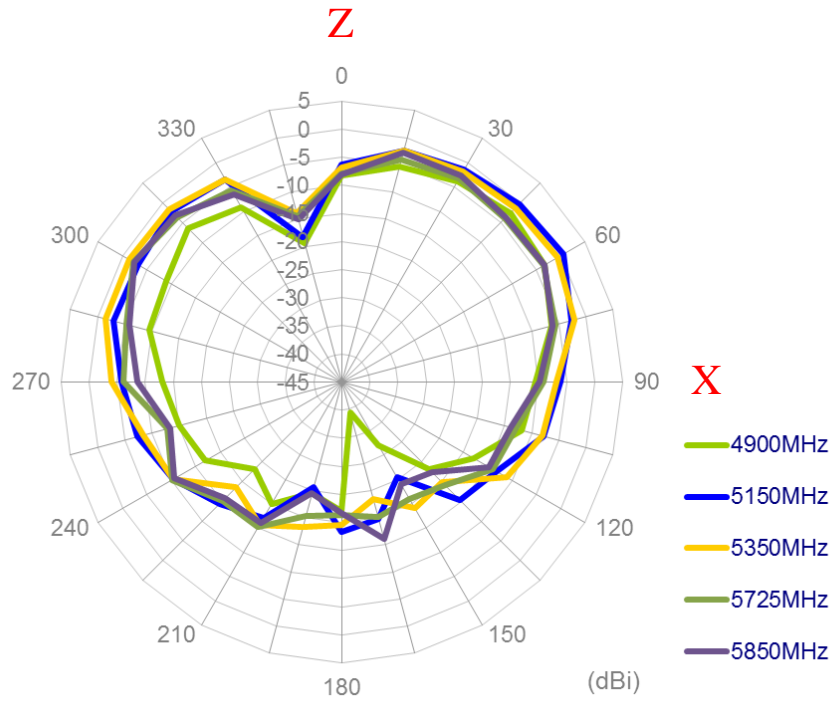

YZ Plane

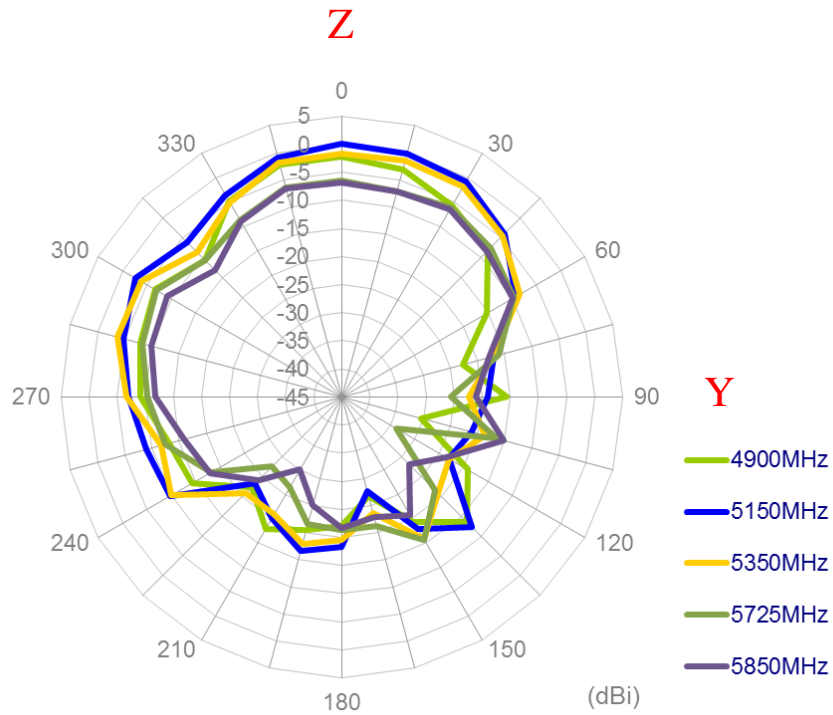

5. Installation

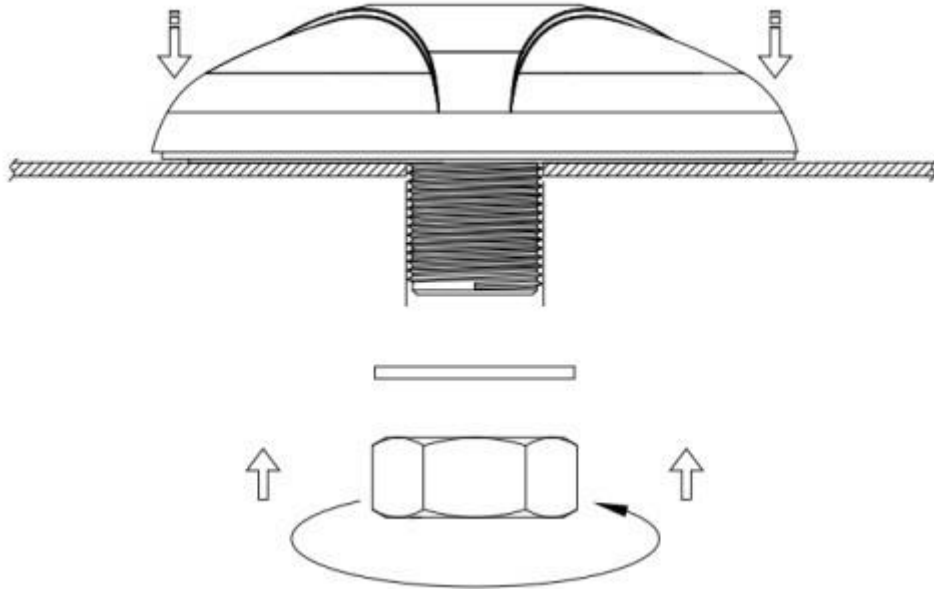

Recommended Torque for Mounting 49 N·m
 Maximum Torque for Mounting 58.8 N·m

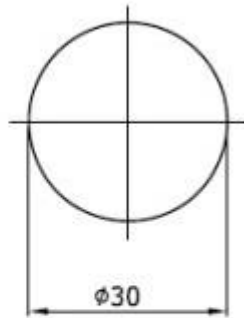

**Thread
 Diameter**

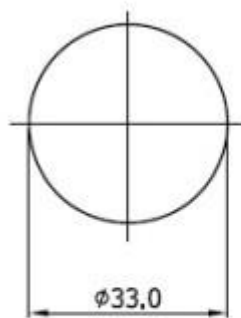

**Recommended
 Mounting Hole**

Unit: mm

6. Drawing

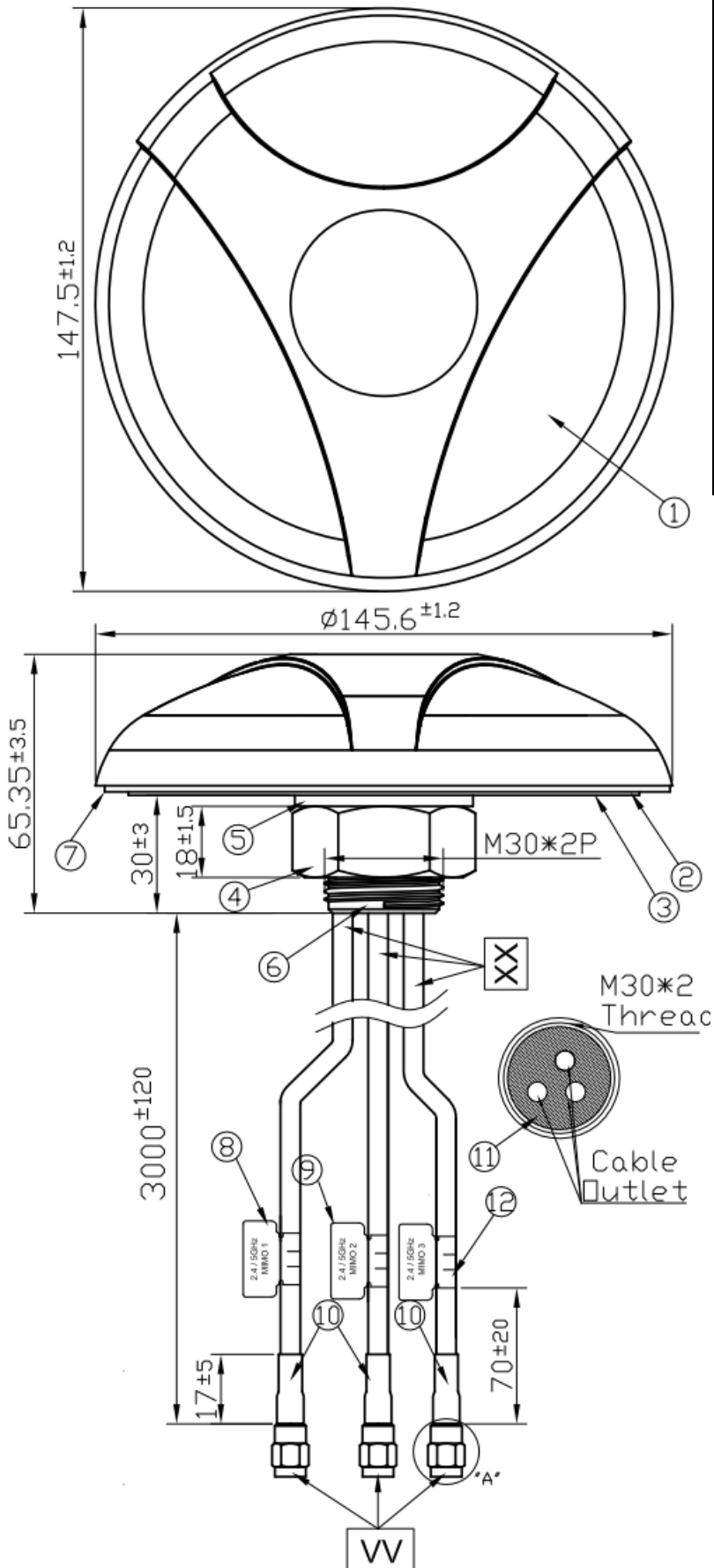

	Name	Material	Finish	QTY
1	Housing	PC 540	Black	1
2	Closed Cell Foam	CR 4305	Black	1
3	3M Double Adhesive	3M 9448 HK	White Liner	1
4	M30 Nut	Steel AISI 1215	Ni Plated	1
5	Washer	Steel AISI 1215	Ni Plated	1
6	M30x 2 Thread 32L	Zinc Alloy	Ni Plated	1
7	Waterproof Rubber	Silicon	Black	1
8	2.4/5 GHz MIMO1 Label (48x30)	Coated Paper	Dark Green	1
9	2.4/5 GHz MIMO2 Label (48x30)	Coated Paper	Green Yellow	1
10	Heat Shrink Tube	PE	Black	3
11	Rubber Stopper	Silicone Rubber	Black	1
12	2.4/5 GHz MIMO3 Label (48x30)	Coated Paper	Lime Green	1

	Name	Spec	Finish	QTY
VV	Connector Type	SMA(M)RP ST	Gold	3
XX	Cable Type	CFD 200	Black	3

7. Packaging

- 1 Antenna per Individual Box (L:165mm:B:165mm:H:125mm)
- Weight 1.078kg

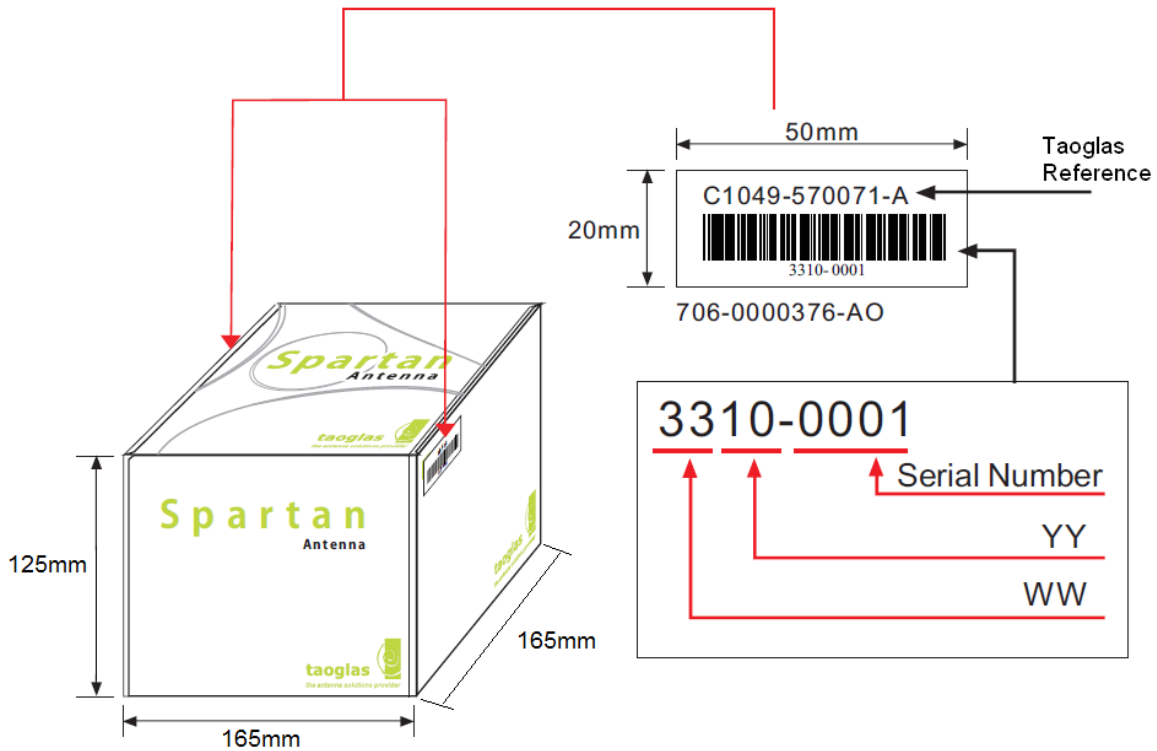

- 8 Individual Boxes per Carton (L:390mm:B:360mm:H:310mm)
- Weight 9.5kg

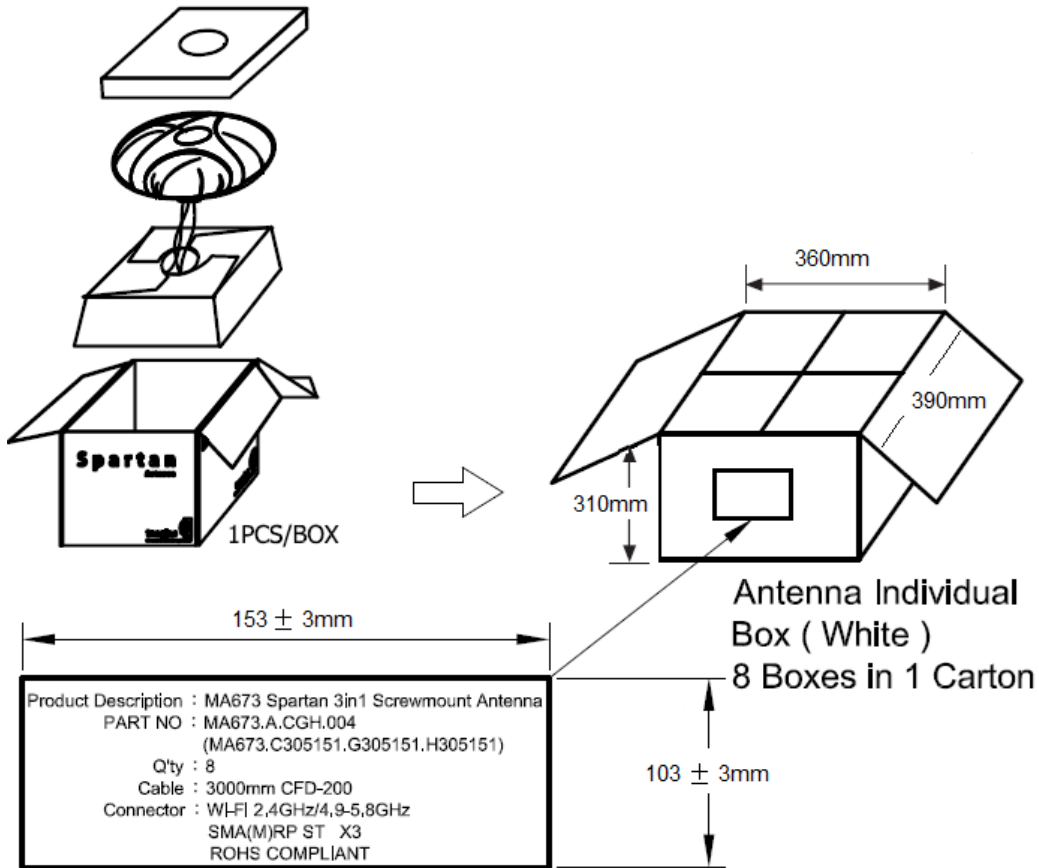

Label x 2 Paste To Both Sides

- 32 Cartons per pallet(110*110cm)
- 256 Pieces per Pallet

