



CX1HSM CRYSTAL

10 kHz to 600 kHz
Miniature Surface Mount
Quartz Crystal for Series Oscillators

DESCRIPTION

The CX1HSM quartz crystal is a high quality tuning fork resonator for use in Series (two cascaded inverters) oscillators. The CX1HSM is hermetically sealed in a rugged, miniature ceramic package. The CX1HSM crystal is manufactured using the STATEK-developed photolithographic process, and was designed utilizing the experience acquired by producing millions of crystals for industrial, commercial, military and medical applications. Maximum process temperature should not exceed 260°C.

FEATURES

- Miniature tuning fork design
- High shock resistance
- Designed for low power applications
- Compatible with hybrid or PC board packaging
- Low aging
- Full military testing available
- Designed and manufactured in the USA

EQUIVALENT CIRCUIT

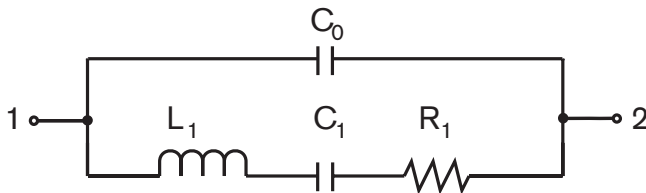

R₁, Motional Resistance L₁, Motional Inductance
C₁, Motional Capacitance C₀, Shunt Capacitance

SUGGESTED LAND PATTERN

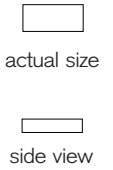
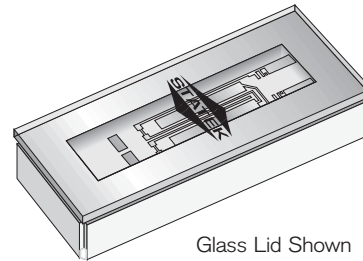
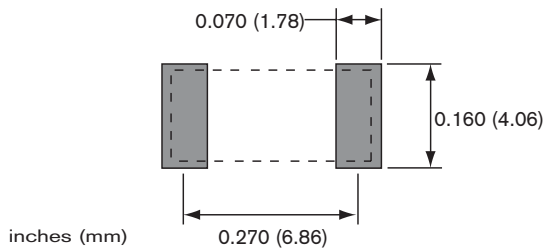

PACKAGE DIMENSIONS

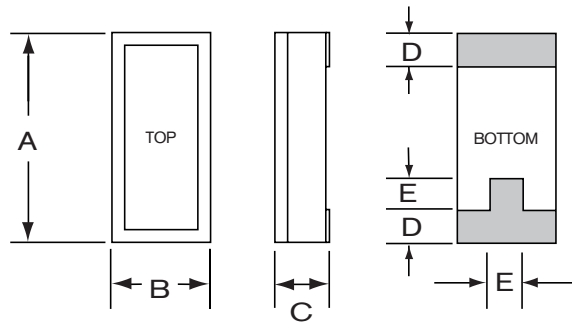

DIM	TYP.		MAX.	
	inches	mm	inches	mm
A	0.315	8.00	0.330	8.38
B	0.140	3.56	0.155	3.94
C	-	-	see below	
D	0.045	1.14	0.055	1.40
E	0.060	1.52	0.070	1.78

DIM "C"	GLASS LID		CERAMIC LID	
	inches	mm	inches	mm
MAX	0.065	1.65	0.070	1.78
SM1	0.067	1.70	0.072	1.83
SM2	0.067	1.70	0.072	1.83
SM3	0.070	1.78	0.075	1.90

CONVENTIONAL SERIES OSCILLATOR CIRCUIT

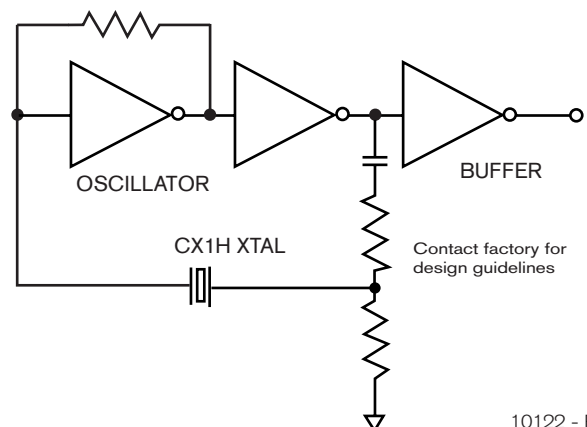

10122 - Rev D



SPECIFICATIONS

Specifications are typical at 25°C unless otherwise noted.
Specifications are subject to change without notice.

Frequency Range 10 kHz to 600 kHz

Standard Calibration Tolerance* (see table below)

Motional Resistance (R_1) Figure 1
MAX.: 10-169.9 kHz, 2x Typ.
170-600 kHz, 2.5x Typ.

Motional Capacitance (C_1) Figure 2

Quality Factor (Q) Figure 3
Min. is 0.25x Typ.

Shunt Capacitance (C_0) 2.0 pF MAX

Drive Level 10-24.9 kHz 1.5 μ W MAX
25-600 kHz 3.0 μ W MAX

Turning Point (T_0)** Figure 4

Temperature Coefficient (k) -0.035 ppm/°C²

Aging, first year 5 ppm MAX

Shock, survival*** 1,000 g, 1ms, 1/2 sine

Vibration, survival*** 20 g RMS, 10-2,000 Hz

Operating Temp. Range -10°C to +70°C (Commercial)
-40°C to +85°C (Industrial)
-55°C to +125°C (Military)

Storage Temp. Range -55°C to +125°C

Max Process Temperature 260°C for 20 sec.

* Tighter frequency calibration available.

** Other turning point available.

*** Higher shock and vibration available.

CX1HSM Standard Calibration Tolerance at 25°C

Frequency Range (kHz)			
10-74.9	75-169.9	170-249.9	250-600
± 30 ppm (0.003%)	± 50 ppm (0.005%)	± 100 ppm (0.01%)	±200 ppm (0.02%)
± 100 ppm (0.01%)	± 100 ppm (0.01%)	± 200 ppm (0.02%)	±500 ppm (0.05%)
± 1000 ppm (0.1%)	± 1000 ppm (0.1%)	± 2000 ppm (0.2%)	±5000 ppm (0.5%)

HOW TO ORDER CX1HSM CRYSTALS

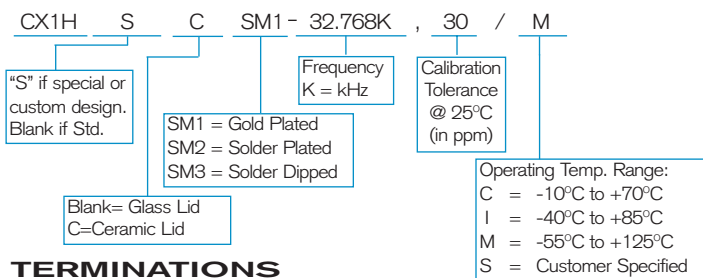

TERMINATIONS

Designation	Termination
SM1	Gold Plated
SM2	Solder Plated
SM3	Solder Dipped

FIGURE 1
CX1H TYPICAL MOTIONAL RESISTANCE (R_1)

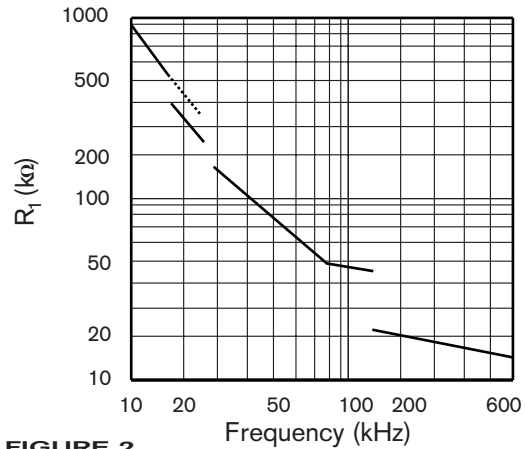

FIGURE 2
CX1H TYPICAL MOTIONAL CAPACITANCE (C_1)

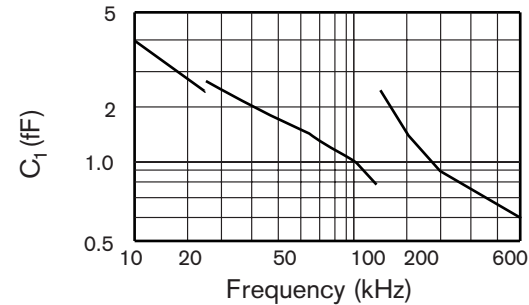

FIGURE 3
CX1H TYPICAL QUALITY FACTOR (Q)

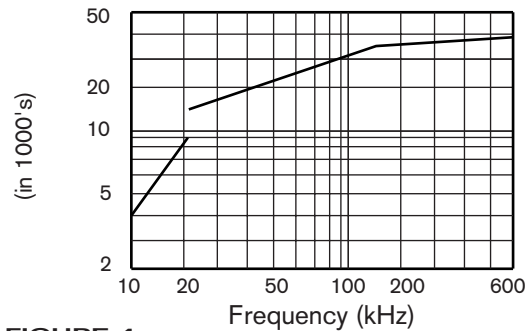
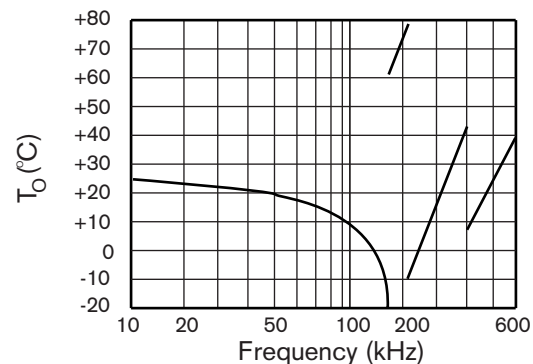

FIGURE 4
CX1H TYPICAL TURNING POINT TEMP. (T_0)



Note: Frequency f at temperature T is related to frequency f_0 at turning point temperature T_0 by:

$$\frac{f-f_0}{f_0} = k(T-T_0)^2$$

PACKAGING

CX1HSM - Tray Pack
- 16mm tape, 7" or 13" reels
(Reference tape and reel data sheet 10109)