

PLEASE CHECK WWW.MOLEX.COM FOR LATEST PART INFORMATION

Part Number: [39910-0312](#)
Status: **Active**
Overview: Eurostyle™ Terminal Blocks
Description: 10.16mm Beau™ Eurostyle™, Fixed Mount PCB Terminal Block, High Voltage, High Power 40A, 12 Circuits

Documents:

[3D Model](#) [RoHS Certificate of Compliance \(PDF\)](#)
[Drawing \(PDF\)](#)

Agency Certification

UL E48521

General

Product Family Terminal Blocks
 Series [39910](#)
 Application N/A
 Component Type One Piece
 Overview [Eurostyle™ Terminal Blocks](#)
 Product Name Eurostyle™ Fixed Mount
 Type Euro Block
 UPC 756054449219

Physical

Circuits (Loaded) 12
 Circuits (maximum) 12
 Color - Resin Black
 Entry Angle Horizontal
 Flammability 94V-0
 Lock to Mating Part None
 Material - Metal Copper
 Material - Plating Mating Tin
 Material - Plating Termination Tin
 Material - Resin Polyester
 Net Weight 119.564/g
 Number of Rows 1
 Orientation Vertical
 PC Tail Length 4.10mm
 PCB Retention None
 Panel Mount No
 Pitch - Mating Interface 10.16mm
 Pitch - Termination Interface 10.16mm
 Plating min - Mating 3.810µm
 Plating min - Termination 3.810µm
 Polarized to Mating Part Yes
 Shrouded Fully
 Stackable No
 Surface Mount Compatible (SMC) No
 Temperature Range - Operating 130°C
 Termination Interface: Style Through Hole
 Wire Size AWG 10, 12, 14, 16, 18, 8
 Wire Size mm² 0.75 - 6.0

Electrical

Current - Maximum per Contact 40A
 Voltage - Maximum 600V

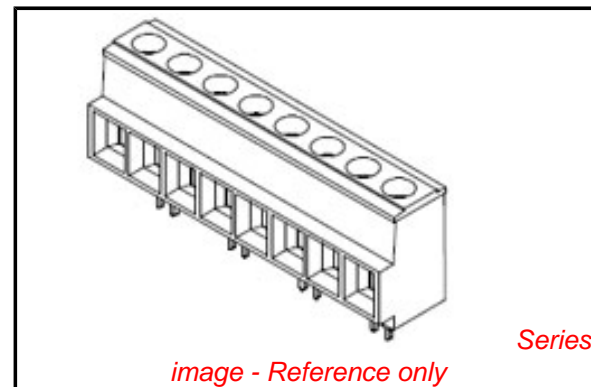

EU RoHS

RoHS Compliant by Exemption
REACH SVHC
Contains SVHC: No
Low-Halogen Status
Not Low-Halogen

China RoHS



Need more information on product environmental compliance?

Email productcompliance@molex.com
 For a multiple part number RoHS Certificate of Compliance, [click here](#)

Please visit the [Contact Us](#) section for any non-product compliance questions.

Search Parts in this Series

[39910Series](#)

Mates With

N/A

Material Info

Old Part Number

913512

Reference - Drawing Numbers

Sales Drawing

SD-39910-002

This document was generated on 12/22/2014

PLEASE CHECK WWW.MOLEX.COM FOR LATEST PART INFORMATION