

Main Product Characteristics

V_{DSS}	-50V
$R_{DS(on)}$	2.1ohm(typ.)
I_D	-130mA

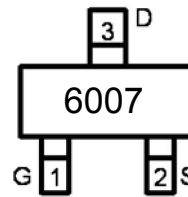

SOT-23



Marking and Pin Assignment

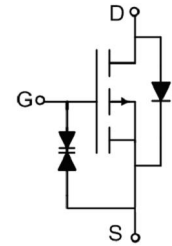

Schematic Diagram

Features and Benefits

- Advanced trench MOSFET process technology
- Special designed for Line current interrupter in telephone sets, Relay, high speed and line transformer drivers and general purpose applications
- Ultra low on-resistance with low gate charge
- Fast switching and reverse body recovery
- 150°C operating temperature
- Lead free product



Description

It utilizes the latest trench processing techniques to achieve the high cell density and reduces the on-resistance. These features combine to make this design an extremely efficient and reliable device for use in line current interrupter in telephone sets and a wide variety of other applications

Absolute Max Rating

Symbol	Parameter	Max.	Units
$I_D @ TC = 25^\circ C$	Continuous Drain Current, $V_{GS} @ -10V$ ①	-130	mA
$I_D @ TC = 100^\circ C$	Continuous Drain Current, $V_{GS} @ -10V$ ①	-100	
I_{DM}	Pulsed Drain Current②	-520	
$P_D @ TC = 25^\circ C$	Power Dissipation③	230	mW
V_{DS}	Drain-Source Voltage	-50	V
V_{GS}	Gate-to-Source Voltage	± 20	V
ESD	ESD Rating (HBM module)	1	KV
$T_J \quad T_{STG}$	Operating Junction and Storage Temperature Range	-55 to + 150	$^\circ C$

Thermal Resistance

Symbol	Characteristics	Typ.	Max.	Units
$R_{\theta JA}$	Junction-to-ambient ($t \leq 10s$) ④	—	556	$^\circ C/W$
	Junction-to-Ambient (PCB mounted, steady-state) ④	—	540	$^\circ C/W$

Electrical Characteristics @ $T_A=25^\circ\text{C}$ unless otherwise specified

Symbol	Parameter	Min.	Typ.	Max.	Units	Conditions
$V_{(BR)DSS}$	Drain-to-Source breakdown voltage	-50	—	—	V	$V_{GS} = 0V, I_D = -10\mu A$
$R_{DS(on)}$	Static Drain-to-Source on-resistance	—	2.1	7	Ω	$V_{GS} = -10V, I_D = -130mA$
$V_{GS(th)}$	Gate threshold voltage	-0.8	—	-2	V	$V_{DS} = V_{GS}, I_D = -1mA$
I_{DSS}	Drain-to-Source leakage current	—	—	-0.1	μA	$V_{DS} = -40V, V_{GS} = 0V$
		—	—	-1		$V_{DS} = -50V, V_{GS} = 0V$
		—	—	-50		$T_J = 125^\circ\text{C}$
I_{GSS}	Gate-to-Source forward leakage	—	—	10	μA	$V_{GS} = 20V$
		-10	—	—		$V_{GS} = -20V$
g_{fs}	Forward Transconductance	50	—	—	S	$V_{DS} = -25V, I_D = -130mA$
C_{iss}	Input Capacitance	—	45	—	pF	$V_{GS} = 0;$
C_{oss}	Output Capacitance	—	18	—		$V_{DS} = -5V;$
C_{rss}	Reverse Transfer Capacitance	—	11	—		$f = 1\text{ MHz}$
$t_{d(on)}$	Turn-On Delay Time	—	3.1	—	ns	$V_{DD} = -15V;$ $I_D = -2.5A;$ $RL = 50\Omega$
t_r	Rise Time	—	1.3	—		
$t_{d(off)}$	Turn-Off Delay Time	—	18	—		
t_f	Fall Time	—	7.5	—		

Source-Drain Ratings and Characteristics

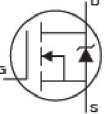
Symbol	Parameter	Min.	Typ.	Max.	Units	Conditions
I_S	Continuous Source Current (Body Diode)	—	—	130	mA	MOSFET symbol showing the integral reverse p-n junction diode. 
I_{SM}	Pulsed Source Current (Body Diode)	—	—	520	mA	
V_{SD}	Diode Forward Voltage	—	—	-1.3	V	$I_S = -130mA, V_{GS} = 0V$

Notes:

- ① The maximum current rating is limited by bond-wires.
- ② Repetitive rating; pulse width limited by max. junction temperature.
- ③ The power dissipation PD is based on max. junction temperature, using junction-to-ambient thermal resistance.
- ④ The value of $R_{\theta JA}$ is measured with the device mounted on 1in 2 FR-4 board with 2oz. Copper, in a still air environment with $T_A = 25^\circ\text{C}$

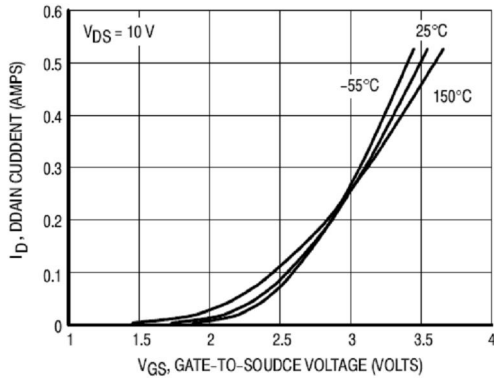

Fig 1: Transfer Characteristics

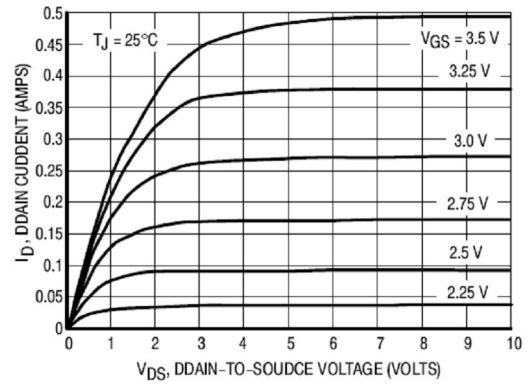

Fig 2: Out Put Curve

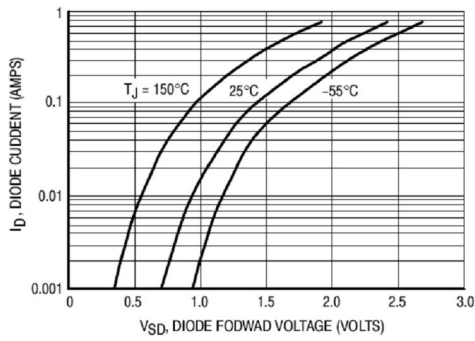

Fig 3: Body Diode Forward Curve

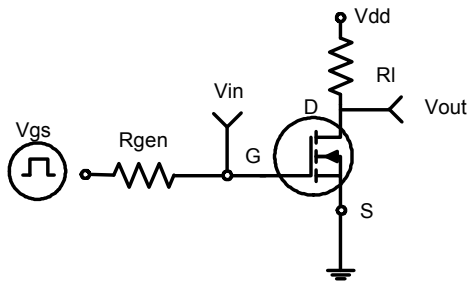

Fig 4: Switching Test Circuit

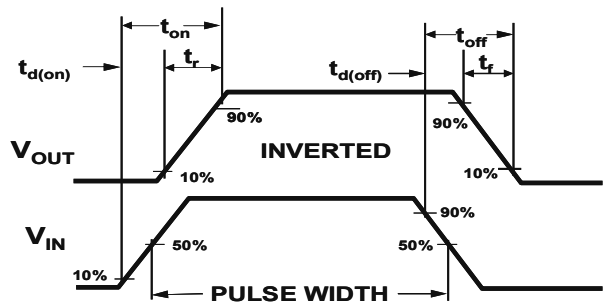
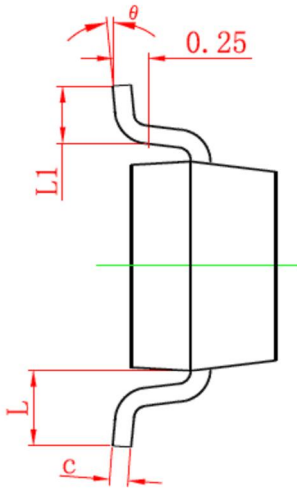
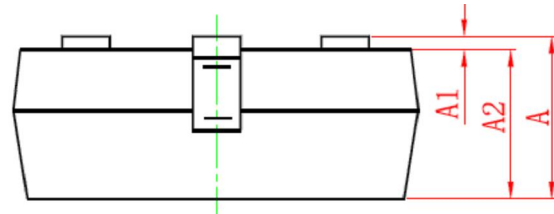
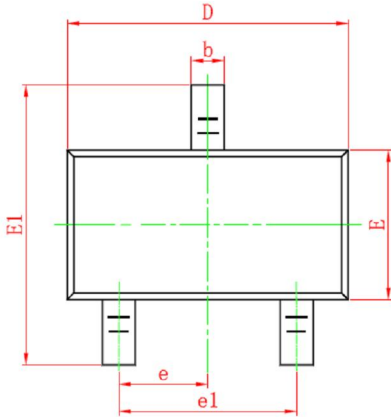

Fig 5: Switching Waveforms

SOT-23 PACKAGE INFORMATION

Dimensions in Millimeters (UNIT:mm)



Symbol	Dimensions in Millimeters	
	MIN.	MAX.
A	0.900	1.150
A1	0.000	0.100
A2	0.900	1.050
b	0.300	0.500
c	0.080	0.150
D	2.800	3.000
E	1.200	1.400
E1	2.250	2.550
e	0.950TYP	
e1	1.800	2.000
L	0.550REF	
L1	0.300	0.500
θ	0°	8°

NOTES

1. All dimensions are in millimeters.
2. Tolerance $\pm 0.10\text{mm}$ (4 mil) unless otherwise specified
3. Package body sizes exclude mold flash and gate burrs. Mold flash at the non-lead sides should be less than 5 mils.
4. Dimension L is measured in gauge plane.
5. Controlling dimension is millimeter, converted inch dimensions are not necessarily exact.

Ordering and Marking Information

Device Marking: 6007

Package (Available)
SOT-23
Operating Temperature Range
C : -55 to 150 °C

Devices per Unit

Package Type	Units/ Tube	Tubes/ Inner Box	Units/ Inner Box	Inner Boxes/ Carton Box	Units/ Carton Box
SOT23	3000pcs	10pcs	30000pcs	4pcs	120000pcs

Reliability Test Program

Test Item	Conditions	Duration	Sample Size
High Temperature Reverse Bias(HTRB)	$T_j=125^{\circ}\text{C}$ or 150°C @ 80% of Max $V_{DSS}/V_{CES}/V_R$	168 hours 500 hours 1000 hours	3 lots x 77 devices
High Temperature Gate Bias(HTGB)	$T_j=125^{\circ}\text{C}$ or 150°C @ 100% of Max V_{GSS}	168 hours 500 hours 1000 hours	3 lots x 77 devices