

RT3-R10D3WR

SMD-DIP 10 Package

- Efficiency up to 75%
- Isolation voltage: 3KVDC
- Operating temperature range: -40°C to +85°C
- Miniature SMD package
- Surface mounted design
- No external components
- International standard pin-out
- Continuous Short Circuit Protection

RoHS



RT3-S10D3WR series is specially designed for applications where an isolated voltage is required in a distributed power supply system. It is suitable for:

1. Where the voltage of the input power supply is stable (voltage variation: $\pm 5\%V_{in}$);
2. Where isolation is necessary between input and output (isolation voltage $\leq 3000VDC$);
3. Where has high requirement of line regulation, load regulation and the ripple & noise of the output voltage.

Selection Guide

Part No.	Input Voltage (VDC)	Output		Efficiency (%Min./Typ.) @ Full Load	Max. Capacitive Load (μF)
	Nominal (Range)	Output Voltage (VDC)	Output Current (mA) (Max./Min.)		
RT3- 0503R10D3WR	5 (4.75-5.25)	3.3	243/25	54/58	220
RT3- 0505R10D3WR		5	200/20	68/72	
RT3- 0512R10D3WR		12	83/9	69/73	
RT3- 0515R10D3WR		15	67/7	70/74	
RT3- 1205R10D3WR	12 (11.4-12.6)	5	200/20	69/73	
RT3- 1212R10D3WR		12	83/9	69/73	
RT3- 2405R10D3WR	24 (22.8-25.2)	5	200/20	69/73	
RT3- 2412R10D3WR		12	83/9	69/73	

Input Specifications

Item	Operating Conditions	Min.	Typ.	Max.	Unit
Input Current (full load / no-load)	5V input	--	270/15	--	mA
	12V input	--	115/10	--	
	24V input	--	56/7	--	
Surge Voltage (1sec. max.)	5V input	-0.7	--	9	VDC
	12V input	-0.7	--	18	
	24V input	-0.7	--	30	
Reflected Ripple Current		--	15	--	mA
Input Filter		Capacitance Filter			

Output Specifications

Item	Operating Conditions	Min.	Typ.	Max.	Unit
Output Voltage Accuracy	100% load	--	--	± 3	%
Line Regulation	Input voltage change: $\pm 1\%$	--	--	± 0.25	
Load Regulation	10%-100% load	3.3VDC output	--	3	
		Other output	--	2	
Ripple*	20MHz bandwidth	--	10	--	mVp-p
Noise*		--	50	--	
Temperature Coefficient	100% load	--	--	± 0.03	%/°C
Short Circuit Protection		Continuous, self-recovery			

Note: *Ripple and noise tested with parallel cable method, please see DC-DC Converter Application Notes for specific operation methods.

RT3-R10D3WR

General Specifications						
Item	Operating Conditions	Min.	Typ.	Max.	Unit	
Isolation Voltage	Input-output, with the test time of 1 minute and the leak current lower than 1mA	3000	--	--	VDC	
Isolation Resistance	Input-output, isolation Voltage 500VDC	1000	--	--	MΩ	
Isolation Capacitance	Input-output, 100KHz/0.1V	--	20	--	pF	
Operating Temperature	Derating when operating temperature up to 71°C, (see Fig. 1)	-40	--	85	°C	
Storage Temperature		-55	--	125		
Casing Temperature Rise	Ta =25°C	--	25	--		
Pin Welding Resistance Temperature	Welding spot is 1.5mm away from the casing, 10 seconds	--	--	300		
Reflow Soldering Temperature		Peak temp. ≤245°C, maximum duration time ≤60s at 217°C. For actual application, please refer to IPC/JEDEC J-STD-020D.1.				
Storage Humidity	Non-condensing	--	--	95	%	
Switching Frequency	100% load, nominal input voltage	--	100	300	KHz	
MTBF	MIL-HDFK-217F@25°C	3500	--	--	K hours	

Physical Specifications	
Casing Material	Black flame-retardant heat-proof epoxy resin (UL94-V0)
Package Dimensions	15.24*11.20*7.25mm
Weight	2.0g(Typ.)
Cooling Method	Free air convection

EMC Specifications			
EMI	Conducted disturbance	CISPR22/EN55022	CLASS B (see Fig. 3 for recommended circuit)
	Radiated emission	CISPR22/EN55022	CLASS B (see Fig. 3 for recommended circuit)
EMS	Electrostatic discharge	IEC/EN61000-4-2	Contact ±6KV perf. Criteria B

Product Characteristic Curve

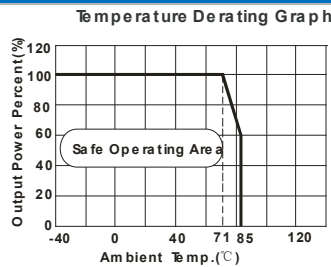
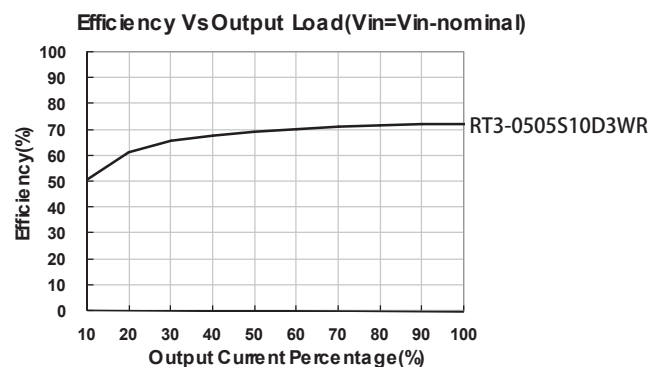
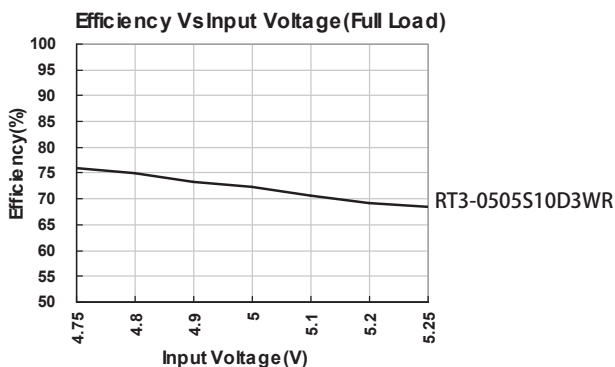
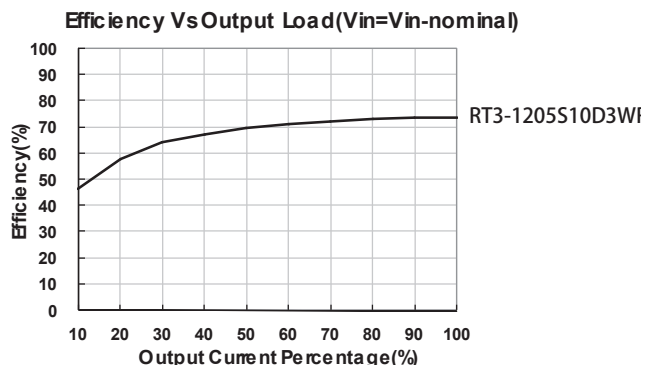
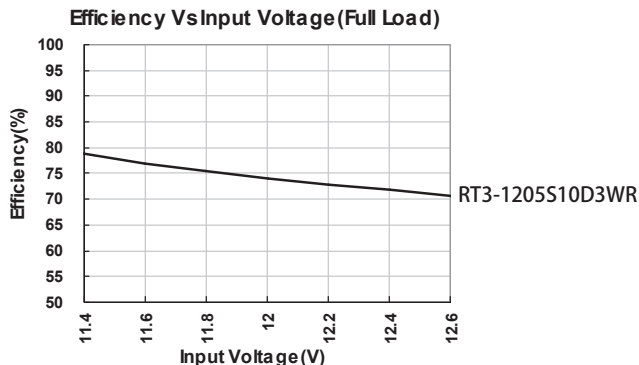

Fig. 1



STAND Juni 2016 Rev.01

RT3-S10D3WR



Design Reference

1. Typical application

If it is required to further reduce input and output ripple, a filter capacitor can be connected to the input and output terminals, see Fig.2. Moreover, choosing suitable filter capacitor is very important, start-up problems may be caused by too large capacitance. To ensure the modules running well, the recommended capacitive load values as shown in Table 1.

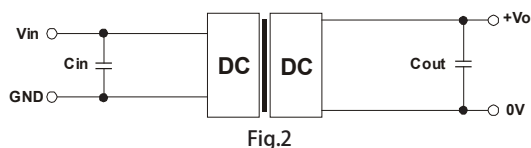

Recommended capacitive load value table (Table 1)

Vin(VDC)	Cin(μF)	Vo (VDC)	Cout(μF)
5	4.7	3.3/5	10
12	2.2	12	2.2
24	1	15	1

It is not recommended to connect any external capacitor when output power is less than 0.5W.

2. EMC typical recommended circuit

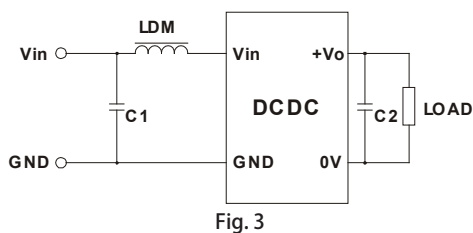

Input voltage (V)		5/12/24
EMI	C1	4.7μF /50V
	C2	Refer to the Cout in Fig.2
	LDM	6.8μH

Note: It is not needed to add the component in the peripheral circuit when parameter with the symbol of "--"

3. Output load requirements

To ensure the module work efficiently and reliably, during the operation, the min. output load should be no less than 10% of the full load. If the actual output power is low, please connect a resistor to the output terminal in parallel, with a recommended resistance which is 10% of the rated power, and derating is required during operation.

DIMENSIONS and recommended layout

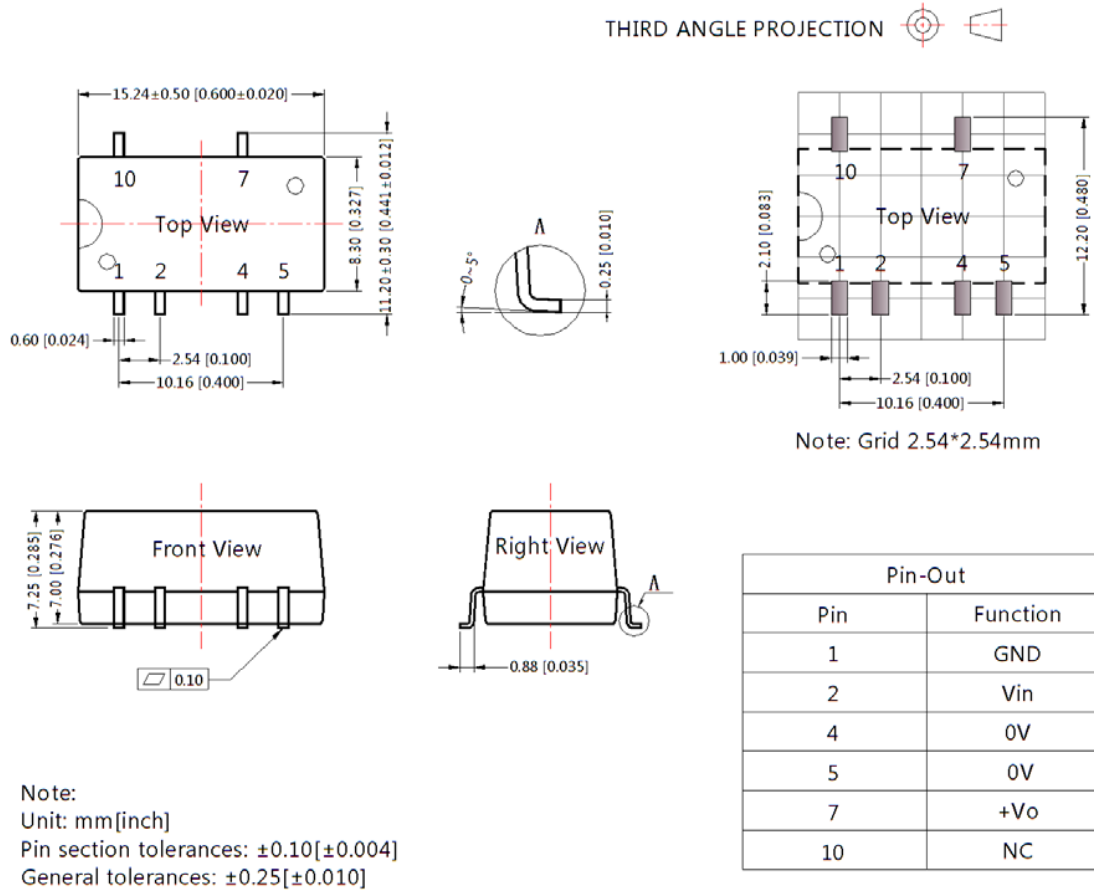

If the product is operated out of the min. load requirement, the product performance may not meet all parameter indexes in this datasheet;
The max. capacitive load offered is tested at nominal input voltage and full load;
Unless otherwise specified, parameter indexes in this datasheet is measured under the conditions of $T_a=25^{\circ}\text{C}$, humidity < 75% with nominal input voltage and rated output load;
All testing methods in this datasheet are based on our Company' s corporate standards;
The parameter indexes above are for the modules listed in this datasheet, for non-standard module's parameter indexes, please contact our technicians for specific information;
We can provide custom design;
Specifications are subject to change without prior notice.

The models listed here are just standard type. If you need a product with special specification or you have questions regarding packing standards (Tube oder Tape/Reel) as well as application support, please contact our specialists: sales@rsg-electronic.de or +49 69-984047-41/-28