

HEXFET® Power MOSFET

**Application**

- Optimized for UPS/Inverter Applications
- Low Voltage Power Tools

**Benefits**

- Fully Characterized Avalanche Voltage and Current
- Lead-Free, RoHS Compliant

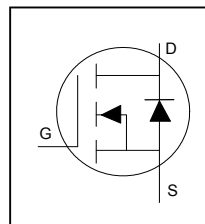

|                                                            |              |           |
|------------------------------------------------------------|--------------|-----------|
| <b>V<sub>DS</sub></b>                                      | <b>30</b>    | <b>V</b>  |
| <b>R<sub>DS(on)</sub> max</b><br>(@ V <sub>GS</sub> = 10V) | <b>2.2</b>   | <b>mΩ</b> |
| (@ V <sub>GS</sub> = 4.5V)                                 | <b>3.1</b>   |           |
| <b>Q<sub>g</sub> (typical)</b>                             | <b>40</b>    | <b>nC</b> |
| <b>I<sub>D</sub> (Silicon Limited)</b>                     | <b>179</b> ① | <b>A</b>  |
| <b>I<sub>D</sub> (Package Limited)</b>                     | <b>90A</b>   |           |

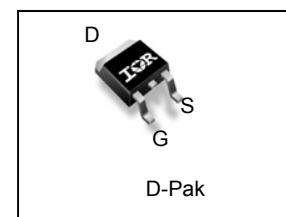

|          |          |          |
|----------|----------|----------|
| <b>G</b> | <b>D</b> | <b>S</b> |
| Gate     | Drain    | Source   |

| Base part number | Package Type | Standard Pack |          | Orderable Part Number |
|------------------|--------------|---------------|----------|-----------------------|
|                  |              | Form          | Quantity |                       |
| IRFR8314PbF      | D-Pak        | Tape and Reel | 2000     | IRFR8314TRPbF         |

**Absolute Maximum Rating**

| Symbol                                  | Parameter                                                         | Max.         | Units |
|-----------------------------------------|-------------------------------------------------------------------|--------------|-------|
| V <sub>DS</sub>                         | Drain-to-Source Voltage                                           | 30           | V     |
| V <sub>GS</sub>                         | Gate-to-Source Voltage                                            | ± 20         |       |
| I <sub>D</sub> @ T <sub>C</sub> = 25°C  | Continuous Drain Current, V <sub>GS</sub> @ 10V (Silicon Limited) | 179①         | A     |
| I <sub>D</sub> @ T <sub>C</sub> = 100°C | Continuous Drain Current, V <sub>GS</sub> @ 10V (Silicon Limited) | 127①         |       |
| I <sub>D</sub> @ T <sub>C</sub> = 25°C  | Continuous Drain Current, V <sub>GS</sub> @ 10V (Package Limited) | 90           |       |
| I <sub>DM</sub>                         | Pulsed Drain Current ②                                            | 357          |       |
| P <sub>D</sub> @T <sub>C</sub> = 25°C   | Maximum Power Dissipation                                         | 125          | W     |
| P <sub>D</sub> @T <sub>C</sub> = 100°C  | Maximum Power Dissipation                                         | 63           | W     |
|                                         | Linear Derating Factor                                            | 0.83         | W/°C  |
| T <sub>J</sub>                          | Operating Junction and                                            | -55 to + 175 | °C    |
| T <sub>STG</sub>                        | Storage Temperature Range                                         |              |       |
|                                         | Soldering Temperature, for 10 seconds (1.6mm from case)           |              |       |

**Thermal Resistance**

| Symbol           | Parameter                         | Typ. | Max. | Units |
|------------------|-----------------------------------|------|------|-------|
| R <sub>θJC</sub> | Junction-to-Case ⑤                | —    | 1.2  | °C/W  |
| R <sub>θJA</sub> | Junction-to-Ambient (PCB Mount) ⑦ | —    | 50   |       |
| R <sub>θJA</sub> | Junction-to-Ambient               | —    | 110  |       |

Notes ① through ⑦ are on page 9

**Static @ T<sub>J</sub> = 25°C (unless otherwise specified)**

| Symbol                                | Parameter                                           | Min. | Typ. | Max. | Units | Conditions                                                                                         |
|---------------------------------------|-----------------------------------------------------|------|------|------|-------|----------------------------------------------------------------------------------------------------|
| BV <sub>DSS</sub>                     | Drain-to-Source Breakdown Voltage                   | 30   | —    | —    | V     | V <sub>GS</sub> = 0V, I <sub>D</sub> = 250μA                                                       |
| ΔBV <sub>DSS</sub> /ΔT <sub>J</sub>   | Breakdown Voltage Temp. Coefficient                 | —    | 18   | —    | mV/°C | Reference to 25°C, I <sub>D</sub> = 1mA ②                                                          |
| R <sub>DS(on)</sub>                   | Static Drain-to-Source On-Resistance                | —    | 1.6  | 2.2  | mΩ    | V <sub>GS</sub> = 10V, I <sub>D</sub> = 90A ④                                                      |
|                                       |                                                     | —    | 2.6  | 3.1  |       | V <sub>GS</sub> = 4.5V, I <sub>D</sub> = 72A ④                                                     |
| V <sub>GS(th)</sub>                   | Gate Threshold Voltage                              | 1.2  | 1.7  | 2.2  | V     | V <sub>DS</sub> = V <sub>GS</sub> , I <sub>D</sub> = 100μA                                         |
| ΔV <sub>GS(th)</sub> /ΔT <sub>J</sub> | Gate Threshold Voltage Coefficient                  | —    | -7.0 | —    | mV/°C |                                                                                                    |
| I <sub>DSS</sub>                      | Drain-to-Source Leakage Current                     | —    | —    | 1.0  | μA    | V <sub>DS</sub> = 24 V, V <sub>GS</sub> = 0V                                                       |
|                                       |                                                     | —    | —    | 150  |       | V <sub>DS</sub> = 24V, V <sub>GS</sub> = 0V, T <sub>J</sub> = 125°C                                |
| I <sub>GSS</sub>                      | Gate-to-Source Forward Leakage                      | —    | —    | 100  | nA    | V <sub>GS</sub> = 20V                                                                              |
|                                       | Gate-to-Source Reverse Leakage                      | —    | —    | -100 |       | V <sub>GS</sub> = -20V                                                                             |
| g <sub>fs</sub>                       | Forward Transconductance                            | 189  | —    | —    | S     | V <sub>DS</sub> = 15V, I <sub>D</sub> = 72A                                                        |
| Q <sub>g</sub>                        | Total Gate Charge                                   | —    | 36   | 54   | nC    | V <sub>DS</sub> = 15V<br>V <sub>GS</sub> = 4.5V<br>I <sub>D</sub> = 72A                            |
| Q <sub>gs1</sub>                      | Pre-V <sub>th</sub> Gate-to-Source Charge           | —    | 10   | —    |       |                                                                                                    |
| Q <sub>gs2</sub>                      | Post-V <sub>th</sub> Gate-to-Source Charge          | —    | 7.7  | —    |       |                                                                                                    |
| Q <sub>gd</sub>                       | Gate-to-Drain Charge                                | —    | 10   | —    |       |                                                                                                    |
| Q <sub>godr</sub>                     | Gate Charge Overdrive                               | —    | 8.3  | —    |       |                                                                                                    |
| Q <sub>sw</sub>                       | Switch Charge (Q <sub>gs2</sub> + Q <sub>gd</sub> ) | —    | 20   | —    |       |                                                                                                    |
| R <sub>G</sub>                        | Gate Resistance                                     | —    | 2.0  | —    |       |                                                                                                    |
| t <sub>d(on)</sub>                    | Turn-On Delay Time                                  | —    | 19   | —    | ns    | V <sub>DD</sub> = 15V<br>I <sub>D</sub> = 72A<br>R <sub>G</sub> = 1.8Ω<br>V <sub>GS</sub> = 4.5V ④ |
| t <sub>r</sub>                        | Rise Time                                           | —    | 98   | —    |       |                                                                                                    |
| t <sub>d(off)</sub>                   | Turn-Off Delay Time                                 | —    | 28   | —    |       |                                                                                                    |
| t <sub>f</sub>                        | Fall Time                                           | —    | 30   | —    |       |                                                                                                    |
| C <sub>iss</sub>                      | Input Capacitance                                   | —    | 4945 | —    | pF    | V <sub>GS</sub> = 0V<br>V <sub>DS</sub> = 15V<br>f = 1.0MHz                                        |
| C <sub>oss</sub>                      | Output Capacitance                                  | —    | 908  | —    |       |                                                                                                    |
| C <sub>rss</sub>                      | Reverse Transfer Capacitance                        | —    | 493  | —    |       |                                                                                                    |

**Avalanche Characteristics**

|                                     |                                              |     |    |
|-------------------------------------|----------------------------------------------|-----|----|
| E <sub>AS</sub> (Thermally limited) | Single Pulse Avalanche Energy ③              | 180 | mJ |
| E <sub>AS</sub> (tested)            | Single Pulse Avalanche Energy Tested Value ⑥ | 279 |    |
| I <sub>A</sub>                      | Avalanche Current                            | 72  | A  |

**Diode Characteristics**

| Symbol          | Parameter                                | Min. | Typ. | Max. | Units | Conditions                                                          |
|-----------------|------------------------------------------|------|------|------|-------|---------------------------------------------------------------------|
| I <sub>S</sub>  | Continuous Source Current (Body Diode) ② | —    | —    | 179① | A     | MOSFET symbol showing the integral reverse p-n junction diode.      |
| I <sub>SM</sub> | Pulsed Source Current (Body Diode) ②     | —    | —    | 357  |       |                                                                     |
| V <sub>SD</sub> | Diode Forward Voltage                    | —    | —    | 1.0  | V     | T <sub>J</sub> = 25°C, I <sub>S</sub> = 72A, V <sub>GS</sub> = 0V ④ |
| t <sub>rr</sub> | Reverse Recovery Time                    | —    | 31   | 47   | ns    | T <sub>J</sub> = 25°C I <sub>F</sub> = 72A, V <sub>DD</sub> = 15V   |
| Q <sub>rr</sub> | Reverse Recovery Charge                  | —    | 87   | 130  | nC    | di/dt = 360A/μs ④                                                   |

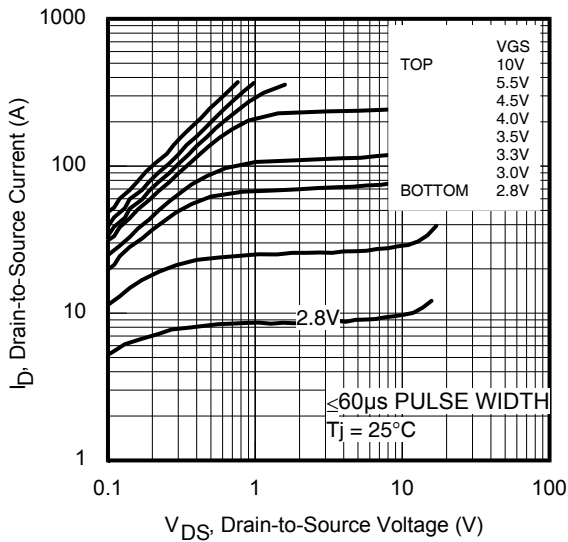
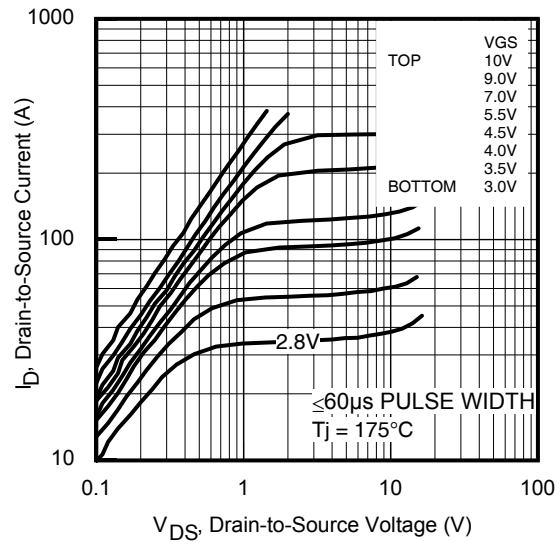
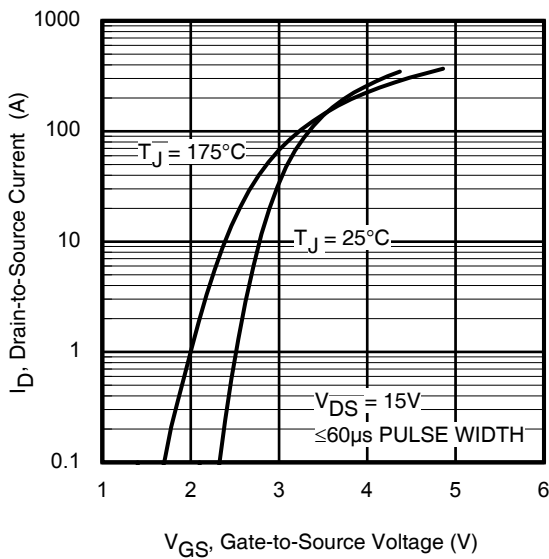
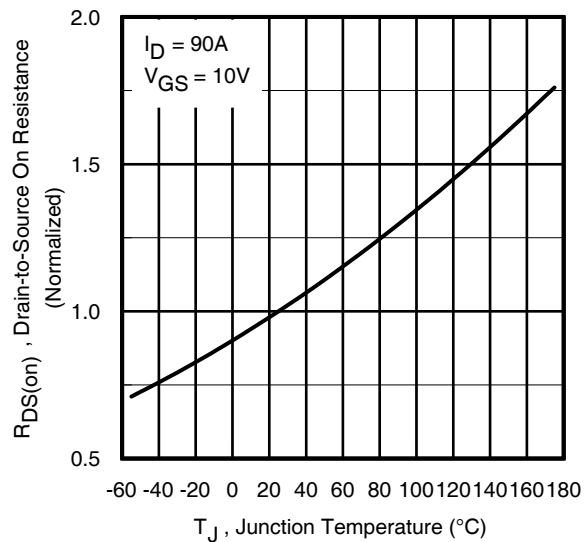
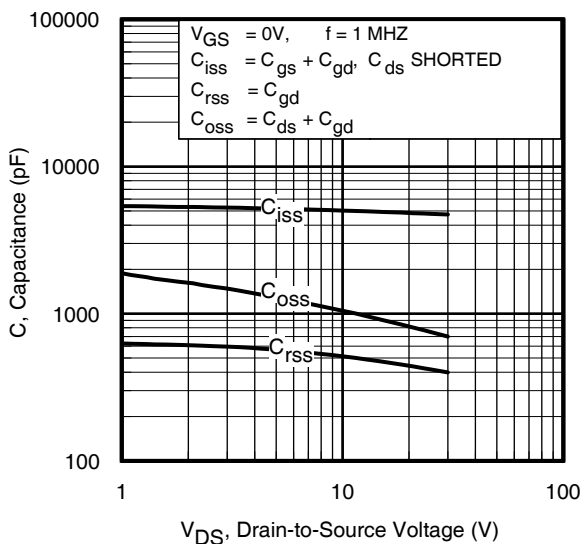
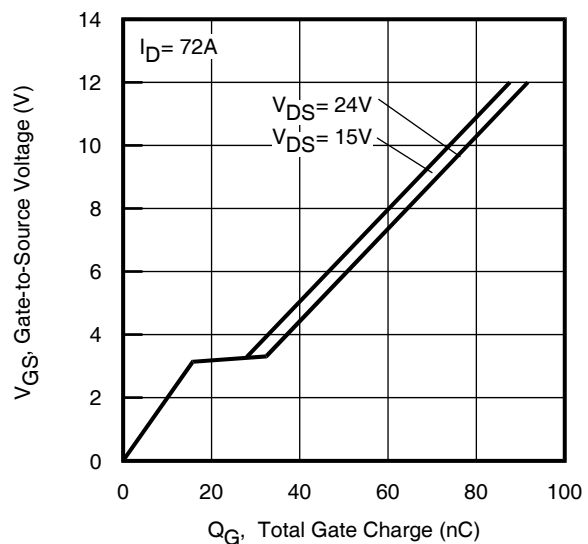
**Fig 1. Typical Output Characteristics**

**Fig 2. Typical Output Characteristics**

**Fig 3. Typical Transfer Characteristics**

**Fig 4. Normalized On-Resistance vs. Temperature**

**Fig 5. Typical Capacitance vs. Drain-to-Source Voltage**

**Fig 6. Typical Gate Charge vs. Gate-to-Source Voltage**

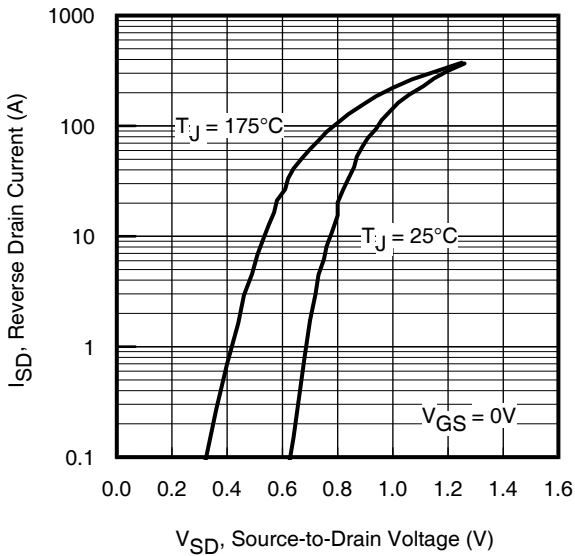

Fig 7. Typical Source-Drain Diode Forward Voltage

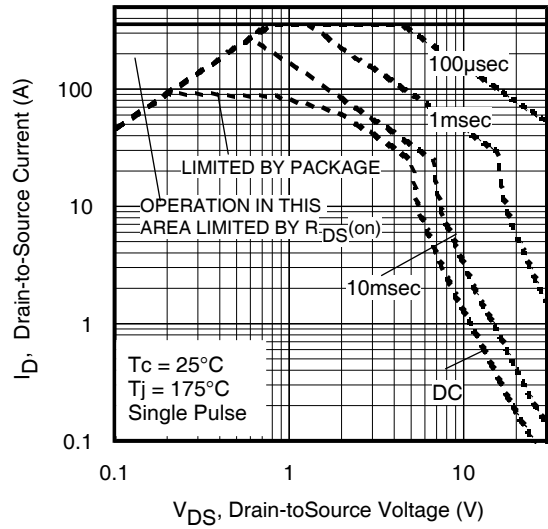

Fig 8. Maximum Safe Operating Area

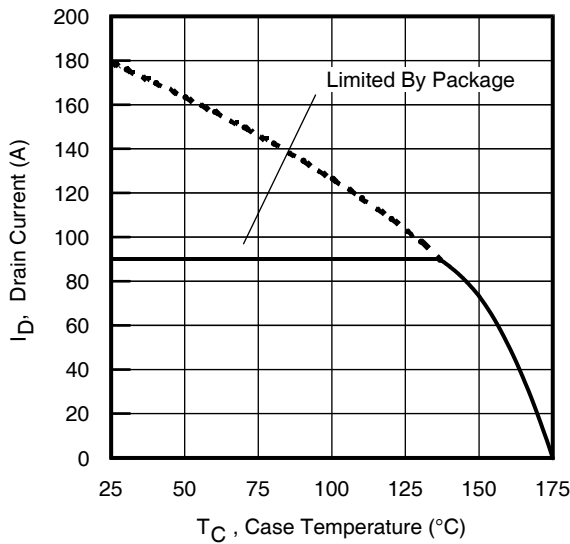

Fig 9. Maximum Drain Current vs. Case Temperature

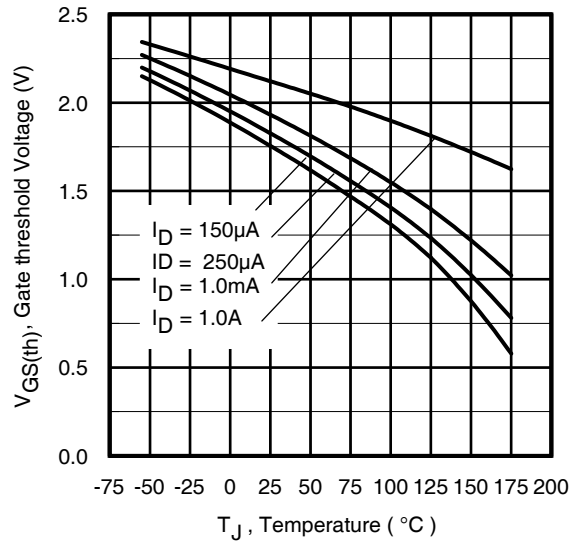

Fig 10. Threshold Voltage vs. Temperature

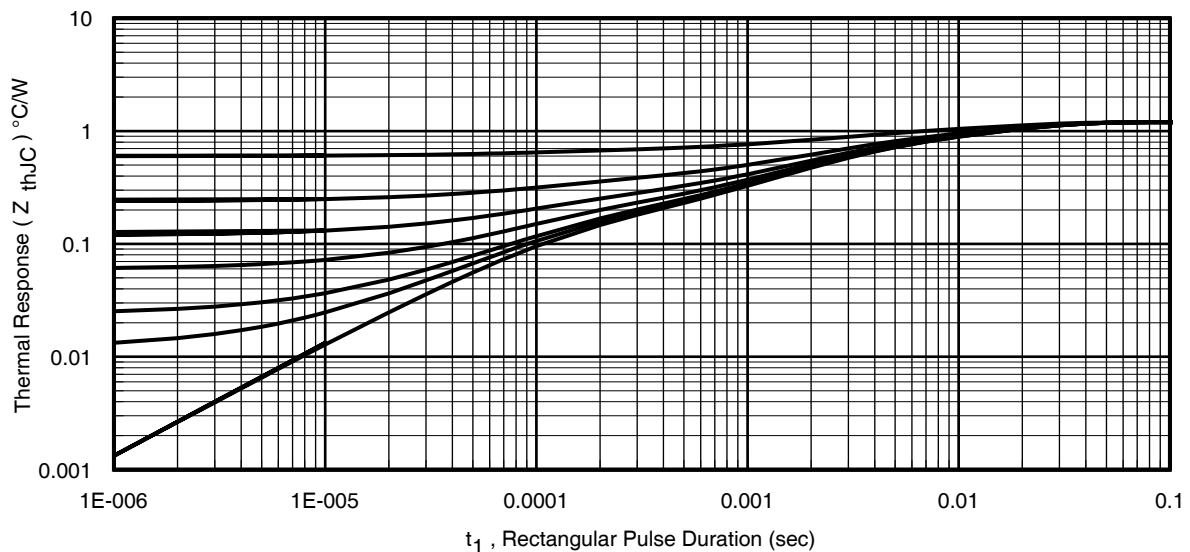

Fig 11. Maximum Effective Transient Thermal Impedance, Junction-to-Case

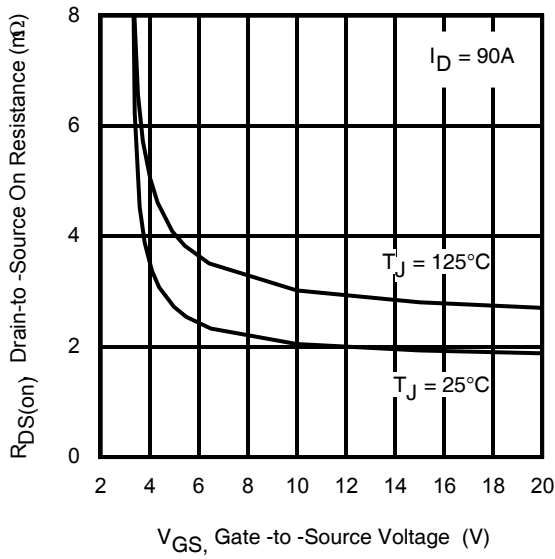

Fig 12. Typical On-Resistance vs. Gate Voltage

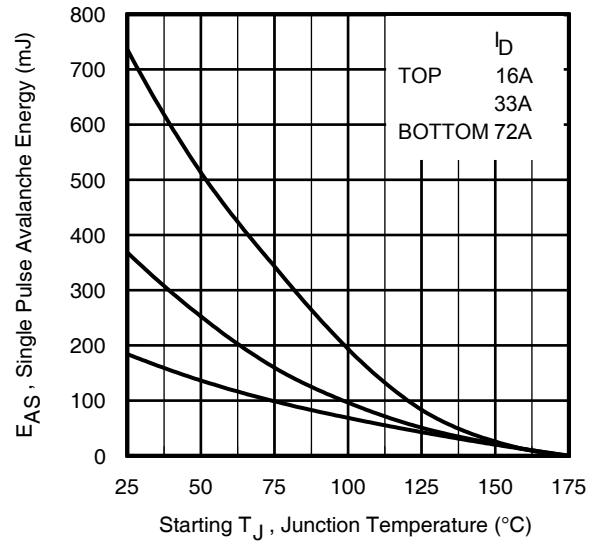
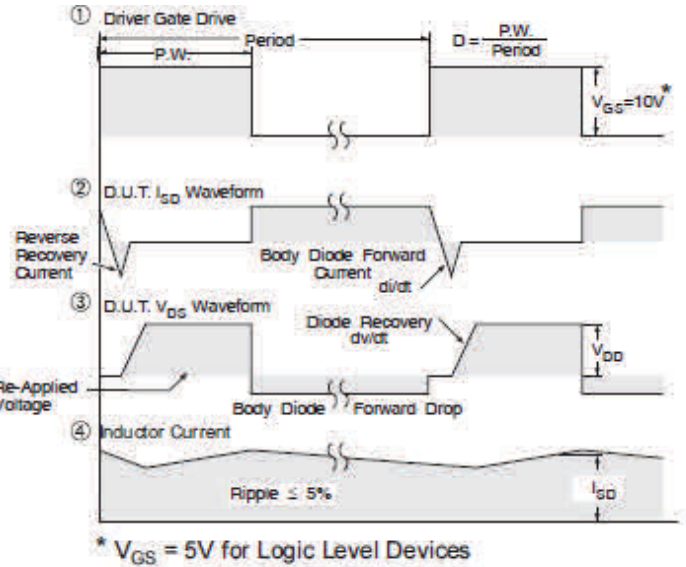
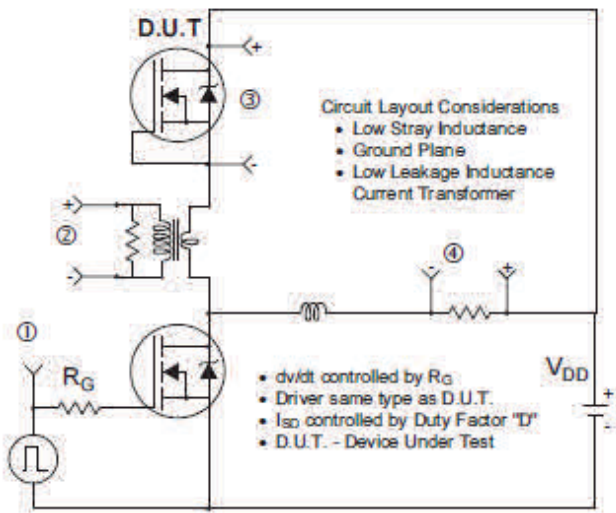
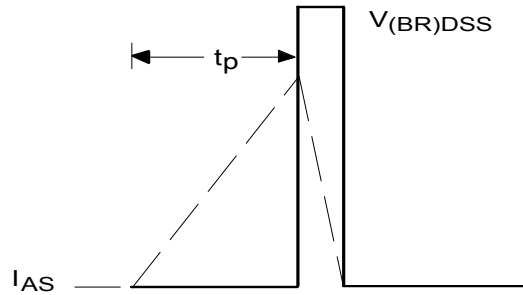
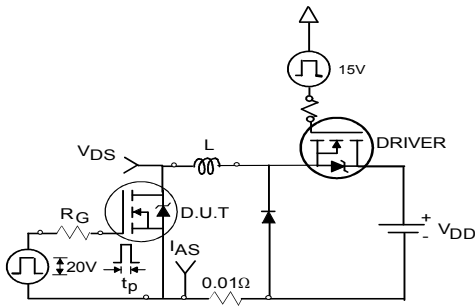

Fig 13. Maximum Avalanche Energy vs. Drain Current

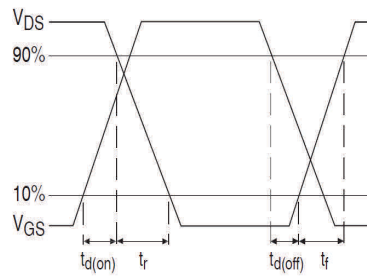
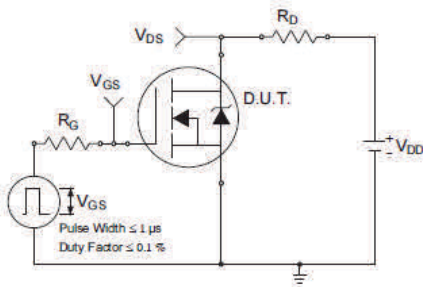

**Fig 14.** Peak Diode Recovery dv/dt Test Circuit for N-Channel HEXFET® Power MOSFETs



**Fig 15a.** Unclamped Inductive Test Circuit

**Fig 15b.** Unclamped Inductive Waveforms



**Fig 16a.** Switching Time Test Circuit

**Fig 16b.** Switching Time Waveforms

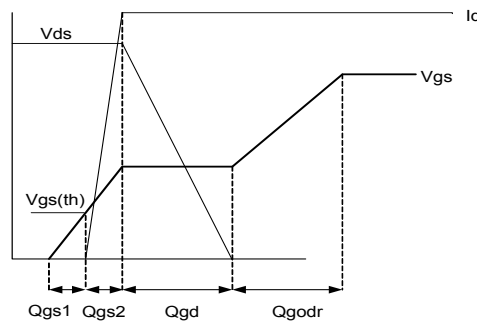
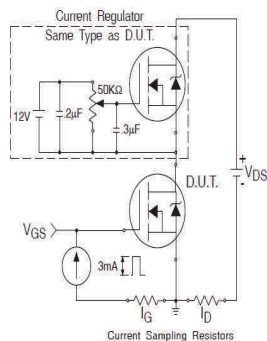

**Fig 17a.** Gate Charge Test Circuit

**Fig 17b.** Gate Charge Waveform

## D-Pak (TO-252AA) Package Outline Dimensions are shown in millimeters (inches)

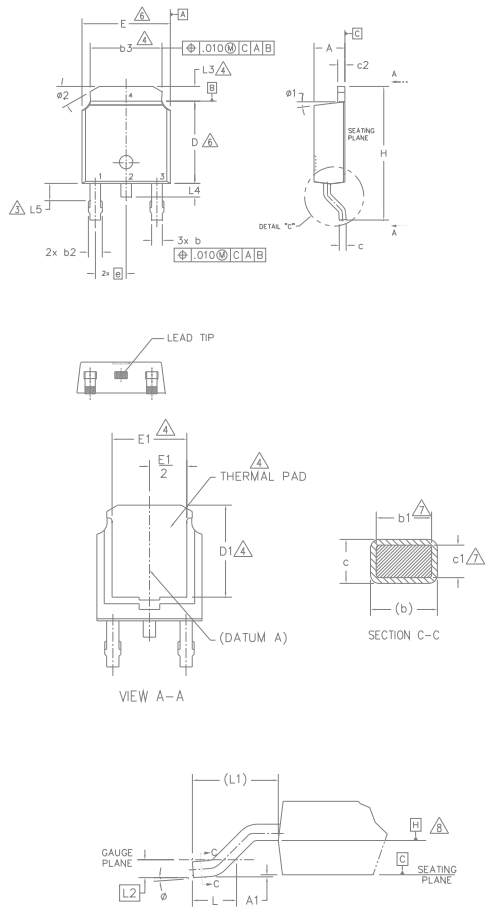

- NOTES:
- 1.- DIMENSIONING AND TOLERANCING PER ASME Y14.5M-1994
  - 2.- DIMENSION ARE SHOWN IN INCHES [MILLIMETERS]
  - 3.- LEAD DIMENSION UNCONTROLLED IN L5.
  - 4.- DIMENSION D1, E1, L3 & b3 ESTABLISH A MINIMUM MOUNTING SURFACE FOR THERMAL PAD.
  - 5.- SECTION C-C DIMENSIONS APPLY TO THE FLAT SECTION OF THE LEAD BETWEEN .005 AND 0.10 [0.13 AND 0.25] FROM THE LEAD TIP.
  - 6.- DIMENSION D & E DO NOT INCLUDE MOLD FLASH. MOLD FLASH SHALL NOT EXCEED .006 [0.15] PER SIDE. THESE DIMENSIONS ARE MEASURED AT THE OUTMOST EXTREMES OF THE PLASTIC BODY.
  - 7.- DIMENSION b1 & c1 APPLIED TO BASE METAL ONLY.
  - 8.- DATUM A & B TO BE DETERMINED AT DATUM PLANE H.
  - 9.- OUTLINE CONFORMS TO JEDEC OUTLINE TO-252AA.

| SYMBOL | DIMENSIONS  |       |           |      | NOTES |
|--------|-------------|-------|-----------|------|-------|
|        | MILLIMETERS |       | INCHES    |      |       |
|        | MIN.        | MAX.  | MIN.      | MAX. |       |
| A      | 2.18        | 2.39  | .086      | .094 |       |
| A1     | -           | 0.13  | -         | .005 |       |
| b      | 0.64        | 0.89  | .025      | .035 |       |
| b1     | 0.64        | 0.79  | .025      | .031 | 7     |
| b2     | 0.76        | 1.14  | .030      | .045 |       |
| b3     | 4.95        | 5.46  | .195      | .215 | 4     |
| c      | 0.46        | 0.61  | .018      | .024 |       |
| c1     | 0.41        | 0.56  | .016      | .022 | 7     |
| c2     | 0.46        | 0.89  | .018      | .035 |       |
| D      | 5.97        | 6.22  | .235      | .245 | 6     |
| D1     | 5.21        | -     | .205      | -    | 4     |
| E      | 6.35        | 6.73  | .250      | .265 | 6     |
| E1     | 4.32        | -     | .170      | -    | 4     |
| e      | 2.29 BSC    |       | .090 BSC  |      |       |
| H      | 9.40        | 10.41 | .370      | .410 |       |
| L      | 1.40        | 1.78  | .055      | .070 |       |
| L1     | 2.74 BSC    |       | .108 REF. |      |       |
| L2     | 0.51 BSC    |       | .020 BSC  |      |       |
| L3     | 0.89        | 1.27  | .035      | .050 | 4     |
| L4     | -           | 1.02  | -         | .040 |       |
| L5     | 1.14        | 1.52  | .045      | .060 | 3     |
| ø      | 0"          | 10"   | 0"        | 10"  |       |
| ø1     | 0"          | 15"   | 0"        | 15"  |       |
| ø2     | 25"         | 35"   | 25"       | 35"  |       |

### LEAD ASSIGNMENTS

### HEXFET

- 1.- GATE
- 2.- DRAIN
- 3.- SOURCE
- 4.- DRAIN

### IGBT & CoPAK

- 1.- GATE
- 2.- COLLECTOR
- 3.- EMITTER
- 4.- COLLECTOR

## D-Pak (TO-252AA) Part Marking Information

EXAMPLE: THIS IS AN IRFR120  
WITH ASSEMBLY  
LOT CODE 1234  
ASSEMBLED ON WW 16, 2001  
IN THE ASSEMBLY LINE "A"

Note: "P" in assembly line position  
indicates "Lead-Free"

"P̄" in assembly line position indicates  
"Lead-Free" qualification to the consumer-level

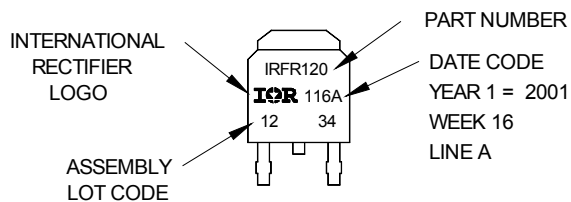

PART NUMBER  
DATE CODE  
YEAR 1 = 2001  
WEEK 16  
LINE A

OR



PART NUMBER  
DATE CODE  
P = DESIGNATES LEAD-FREE  
PRODUCT (OPTIONAL)  
P̄ = DESIGNATES LEAD-FREE  
PRODUCT QUALIFIED TO THE  
CONSUMER LEVEL (OPTIONAL)  
YEAR 1 = 2001  
WEEK 16  
A = ASSEMBLY SITE CODE

Note: For the most current drawing please refer to IR website at <http://www.irf.com/package/>

D-Pak (TO-252AA) Tape & Reel Information Dimensions are shown in millimeters (inches)

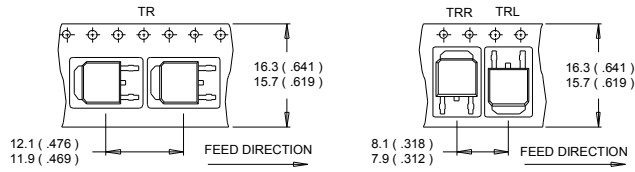

- NOTES :
1. CONTROLLING DIMENSION : MILLIMETER.
  2. ALL DIMENSIONS ARE SHOWN IN MILLIMETERS ( INCHES ).
  3. OUTLINE CONFORMS TO EIA-481 & EIA-541.

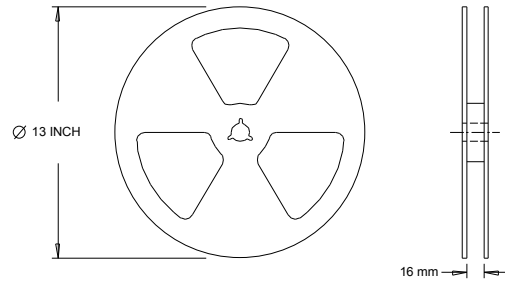

- NOTES :
1. OUTLINE CONFORMS TO EIA-481.

Note: For the most current drawing please refer to IR website at <http://www.irf.com/package/>



**Qualification Information<sup>†</sup>**

|                                   |                                                 |      |
|-----------------------------------|-------------------------------------------------|------|
| <b>Qualification Level</b>        | Industrial<br>(per JEDEC JESD47F) <sup>††</sup> |      |
| <b>Moisture Sensitivity Level</b> | D-Pak                                           | MSL1 |
| <b>RoHS Compliant</b>             | Yes                                             |      |

† Qualification standards can be found at International Rectifier’s web site: <http://www.irf.com/product-info/reliability/>

†† Applicable version of JEDEC standard at the time of product release.

**Notes:**

- ① Calculated continuous current based on maximum allowable junction temperature. Bond wire current limit is 90A by source bonding technology. Note that current limitations arising from heating of the device leads may occur with some lead mounting arrangements. (Refer to AN-1140)
- ② Repetitive rating; pulse width limited by max. junction temperature.
- ③ Limited by  $T_{Jmax}$ , starting  $T_J = 25^{\circ}C$ ,  $L = 0.07mH$ ,  $R_G = 50\Omega$ ,  $I_{AS} = 72A$ ,  $V_{GS} = 10V$ .
- ④ Pulse width  $\leq 400\mu s$ ; duty cycle  $\leq 2\%$ .
- ⑤  $R_{\theta}$  is measured at  $T_J$  approximately  $90^{\circ}C$ .
- ⑥ This value determined from sample failure population, starting  $T_J = 25^{\circ}C$ ,  $L=0.07mH$ ,  $R_G = 50\Omega$ ,  $I_{AS} = 72A$ ,  $V_{GS} = 10V$ .
- ⑦ When mounted on 1" square PCB (FR-4 or G-10 Material). For recommended footprint and soldering techniques refer to application note #AN-994. please refer to application note to AN-994: <http://www.irf.com/technical-info/appnotes/an-994.pdf>

**Revision History**

| <b>Date</b> | <b>Comments</b>                                                              |
|-------------|------------------------------------------------------------------------------|
| 07/01/2014  | The Device is active without bulk part which is removed from Table on page 1 |