

HEXFET® Power MOSFET

| | | |
|--|-------------|-----------|
| V_{DS} | 30 | V |
| $V_{GS\ max}$ | ± 20 | V |
| $R_{DS(on)\ max}$ (@ $V_{GS} = 10V$) | 3.1 | mΩ |
| (@ $V_{GS} = 4.5V$) | 4.6 | |
| $Q_g\ typ$ | 19 | nC |
| I_D (@ $T_{C(Bottom)} = 25°C$) | 50 ⑦ | A |

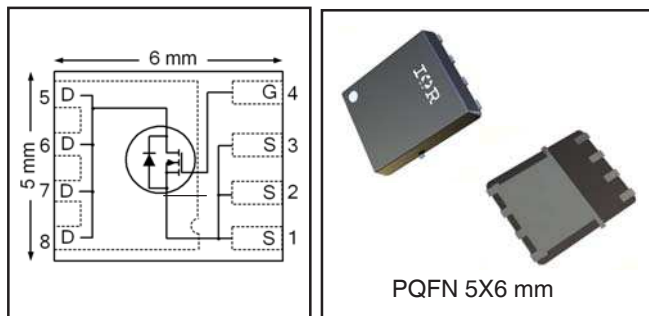

Applications

- Synchronous MOSFET for high frequency buck converters

Features and Benefits

Features

| |
|--|
| Low Thermal Resistance to PCB (< 1.7°C/W) |
| Low Profile (<1.2mm) |
| Industry-Standard Pinout |
| Compatible with Existing Surface Mount Techniques |
| RoHS Compliant Containing no Lead, no Bromide and no Halogen |
| MSL1, Consumer Qualification |

results in
⇒

Benefits

| |
|-----------------------------------|
| Enable better thermal dissipation |
| Increased Power Density |
| Multi-Vendor Compatibility |
| Easier Manufacturing |
| Environmentally Friendlier |
| Increased Reliability |

| Orderable part number | Package Type | Standard Pack | | Note |
|-----------------------|----------------|---------------|----------|------------------|
| | | Form | Quantity | |
| IRFH8318TRPBF | PQFN 5mm x 6mm | Tape and Reel | 4000 | |
| IRFH8318TR2PBF | PQFN 5mm x 6mm | Tape and Reel | 400 | EOL notice # 259 |

Absolute Maximum Ratings

| | Parameter | Max. | Units |
|-------------------------------|--|--------------|-------|
| V_{DS} | Drain-to-Source Voltage | 30 | V |
| V_{GS} | Gate-to-Source Voltage | ± 20 | |
| $I_D @ T_A = 25°C$ | Continuous Drain Current, $V_{GS} @ 10V$ | 27 | A |
| $I_D @ T_A = 70°C$ | Continuous Drain Current, $V_{GS} @ 10V$ | 21 | |
| $I_D @ T_{C(Bottom)} = 25°C$ | Continuous Drain Current, $V_{GS} @ 10V$ | 120 ⑥ ⑦ | |
| $I_D @ T_{C(Bottom)} = 100°C$ | Continuous Drain Current, $V_{GS} @ 10V$ | 76 ⑥ ⑦ | |
| $I_D @ T_C = 25°C$ | Continuous Drain Current, $V_{GS} @ 10V$ (Package Limited) | 50 ⑦ | |
| I_{DM} | Pulsed Drain Current ① | 400 | |
| $P_D @ T_A = 25°C$ | Power Dissipation ② | 3.6 | W |
| $P_D @ T_{C(Bottom)} = 25°C$ | Power Dissipation ② | 59 | |
| | Linear Derating Factor ③ | 0.029 | W/°C |
| T_J T_{STG} | Operating Junction and Storage Temperature Range | -55 to + 150 | °C |

Notes ① through ⑦ are on page 9

Static @ T_J = 25°C (unless otherwise specified)

| | Parameter | Min. | Typ. | Max. | Units | Conditions |
|-------------------------------------|---|------|-------|------|-------|--|
| BV _{DSS} | Drain-to-Source Breakdown Voltage | 30 | — | — | V | V _{GS} = 0V, I _D = 250μA |
| ΔBV _{DSS} /ΔT _J | Breakdown Voltage Temp. Coefficient | — | 0.019 | — | V/°C | Reference to 25°C, I _D = 1.0mA |
| R _{DS(on)} | Static Drain-to-Source On-Resistance | — | 2.5 | 3.1 | mΩ | V _{GS} = 10V, I _D = 20A ③ |
| | | — | 3.6 | 4.6 | | V _{GS} = 4.5V, I _D = 16A ③ |
| V _{GS(th)} | Gate Threshold Voltage | 1.35 | 1.8 | 2.35 | V | V _{DS} = V _{GS} , I _D = 50μA |
| ΔV _{GS(th)} | Gate Threshold Voltage Coefficient | — | -6.0 | — | mV/°C | |
| I _{DSS} | Drain-to-Source Leakage Current | — | — | 1 | μA | V _{DS} = 24V, V _{GS} = 0V |
| | | — | — | 150 | | V _{DS} = 24V, V _{GS} = 0V, T _J = 125°C |
| I _{GSS} | Gate-to-Source Forward Leakage | — | — | 100 | nA | V _{GS} = 20V |
| | Gate-to-Source Reverse Leakage | — | — | -100 | | V _{GS} = -20V |
| g _{fs} | Forward Transconductance | 81 | — | — | S | V _{DS} = 10V, I _D = 20A |
| Q _g | Total Gate Charge | — | 41 | — | nC | V _{GS} = 10V, V _{DS} = 15V, I _D = 20A |
| Q _g | Total Gate Charge | — | 19 | — | nC | V _{DS} = 15V V _{GS} = 4.5V I _D = 20A |
| Q _{gs1} | Pre-V _{th} Gate-to-Source Charge | — | 5.8 | — | | |
| Q _{gs2} | Post-V _{th} Gate-to-Source Charge | — | 2.3 | — | | |
| Q _{gd} | Gate-to-Drain Charge | — | 4.4 | — | | |
| Q _{godr} | Gate Charge Overdrive | — | 6.5 | — | | |
| Q _{sw} | Switch Charge (Q _{gs2} + Q _{gd}) | — | 6.7 | — | | |
| Q _{oss} | Output Charge | — | 18 | — | nC | V _{DS} = 16V, V _{GS} = 0V |
| R _G | Gate Resistance | — | 1.7 | — | Ω | |
| t _{d(on)} | Turn-On Delay Time | — | 15 | — | ns | V _{DD} = 15V, V _{GS} = 4.5V I _D = 20A R _G = 1.8Ω |
| t _r | Rise Time | — | 33 | — | | |
| t _{d(off)} | Turn-Off Delay Time | — | 18 | — | | |
| t _f | Fall Time | — | 12 | — | | |
| C _{iss} | Input Capacitance | — | 3180 | — | pF | V _{GS} = 0V V _{DS} = 10V f = 1.0MHz |
| C _{oss} | Output Capacitance | — | 700 | — | | |
| C _{rss} | Reverse Transfer Capacitance | — | 270 | — | | |

Avalanche Characteristics

| | Parameter | Typ. | Max. | Units |
|-----------------|---------------------------------|------|------|-------|
| E _{AS} | Single Pulse Avalanche Energy ② | — | 160 | mJ |
| I _{AR} | Avalanche Current ① | — | 20 | A |

Diode Characteristics

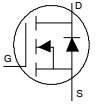
| | Parameter | Min. | Typ. | Max. | Units | Conditions |
|-----------------|--|---|------|------|-------|--|
| I _S | Continuous Source Current (Body Diode) | — | — | 50 ⑦ | A | MOSFET symbol showing the integral reverse p-n junction diode.  |
| I _{SM} | Pulsed Source Current (Body Diode) ① | — | — | 400 | | |
| V _{SD} | Diode Forward Voltage | — | — | 1.0 | V | T _J = 25°C, I _S = 20A, V _{GS} = 0V ③ |
| t _{rr} | Reverse Recovery Time | — | 16 | 24 | ns | T _J = 25°C, I _F = 20A, V _{DD} = 15V |
| Q _{rr} | Reverse Recovery Charge | — | 35 | 53 | nC | di/dt = 380A/μs ③ |
| t _{on} | Forward Turn-On Time | Time is dominated by parasitic Inductance | | | | |

Thermal Resistance

| | Parameter | Typ. | Max. | Units |
|---------------------------|-----------------------|------|------|-------|
| R _{θJC} (Bottom) | Junction-to-Case ④ | — | 1.7 | °C/W |
| R _{θJC} (Top) | Junction-to-Case ④ | — | 32 | |
| R _{θJA} | Junction-to-Ambient ⑤ | — | 35 | |
| R _{θJA} (<10s) | Junction-to-Ambient ⑤ | — | 22 | |

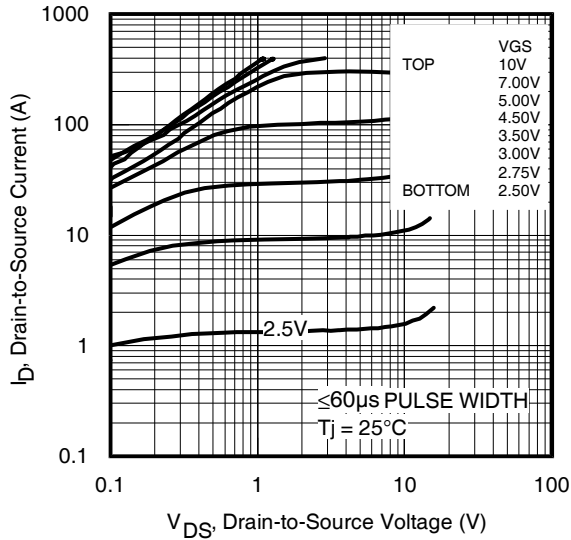
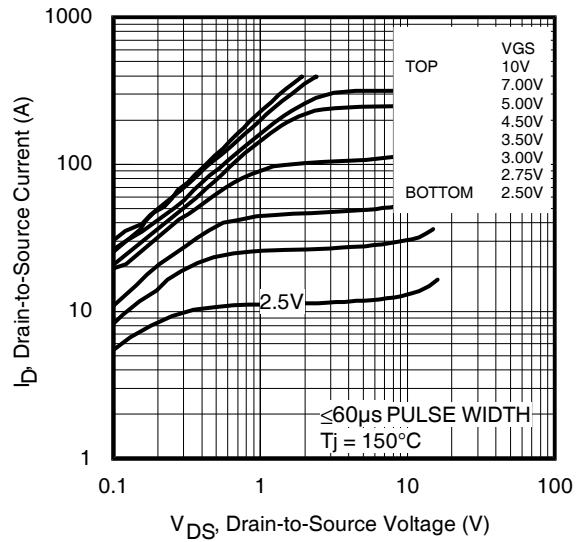
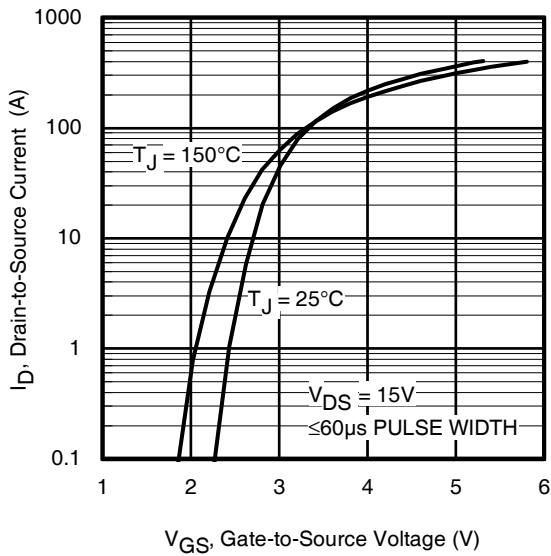
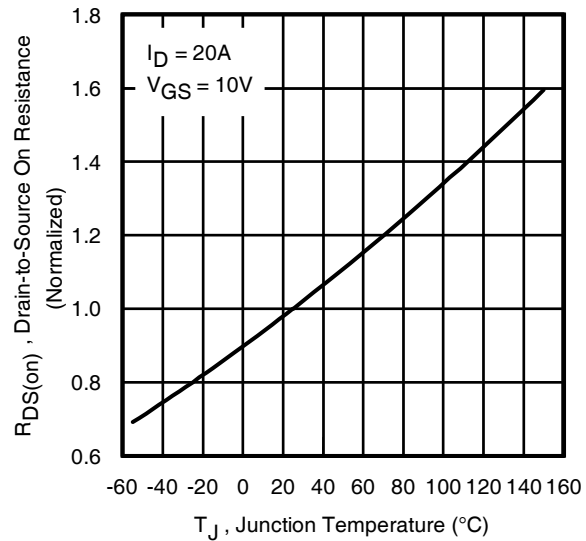
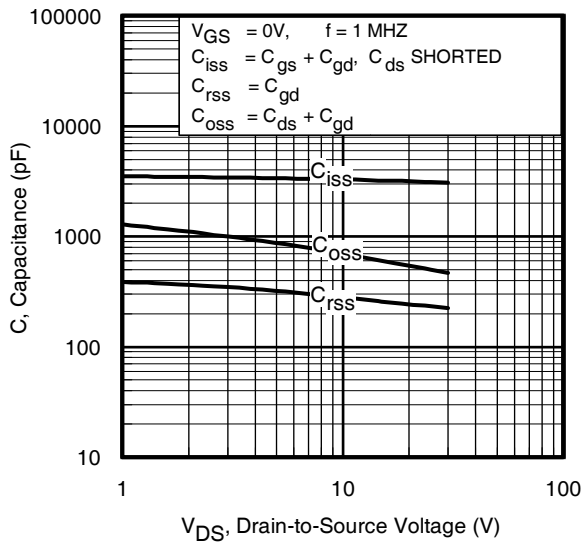
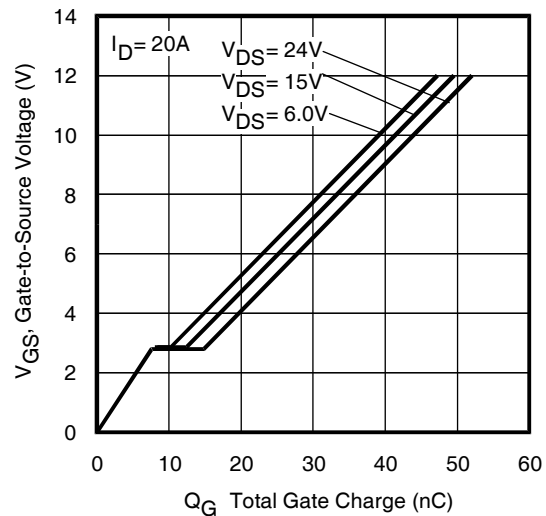
Fig 1. Typical Output Characteristics

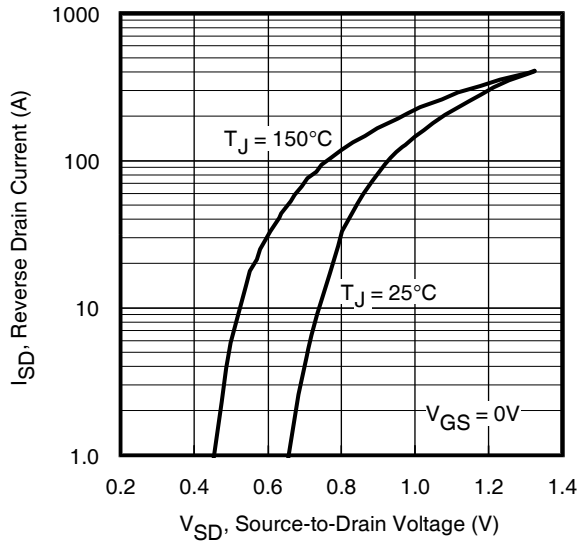
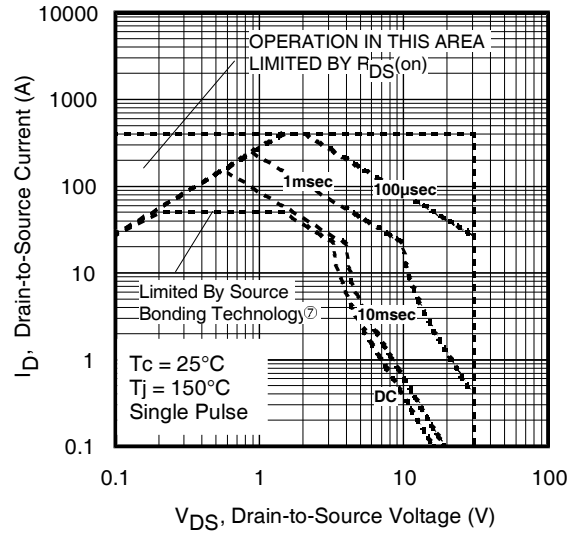
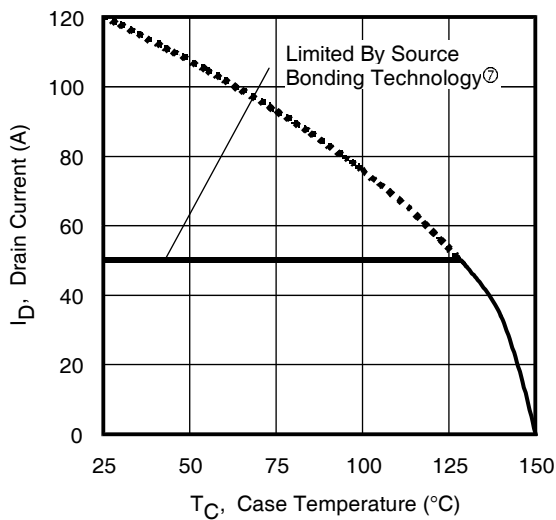
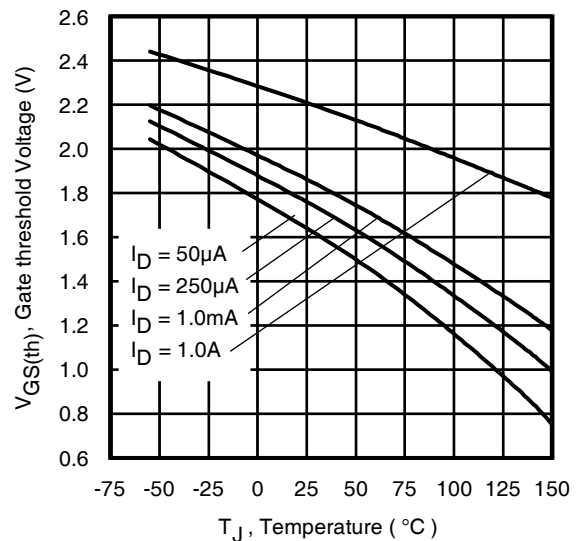
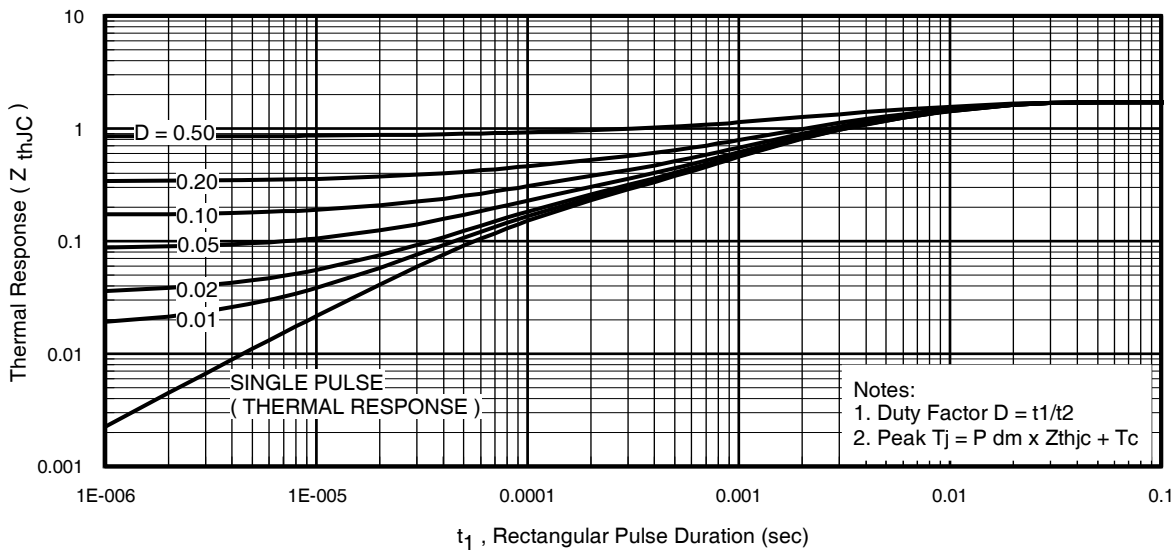
Fig 2. Typical Output Characteristics

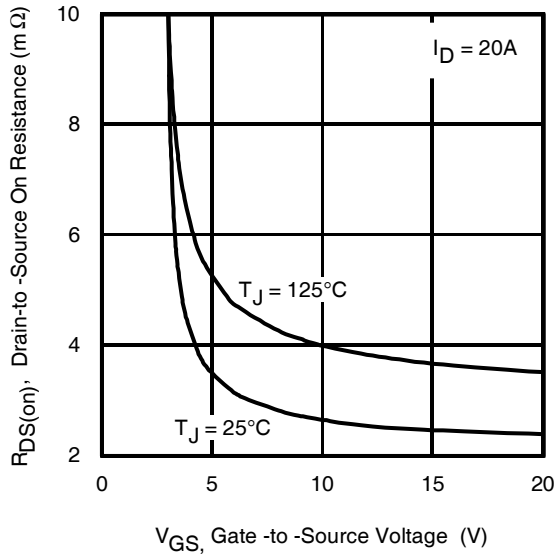
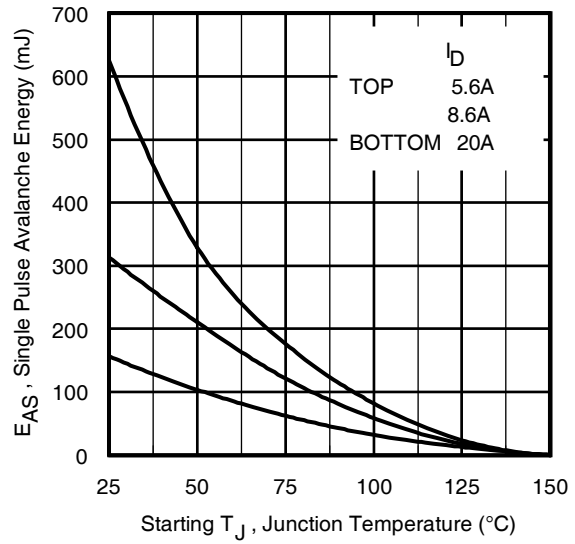
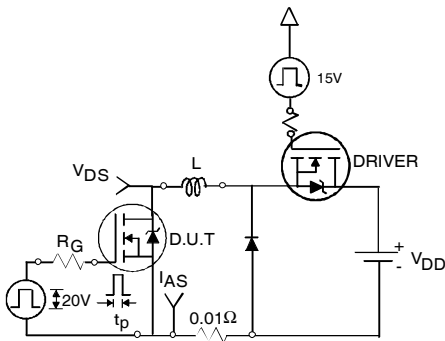
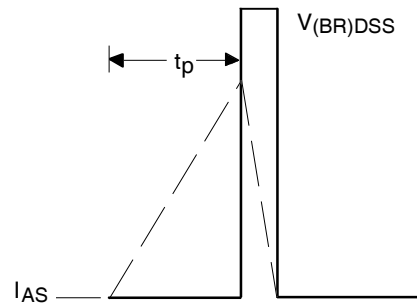
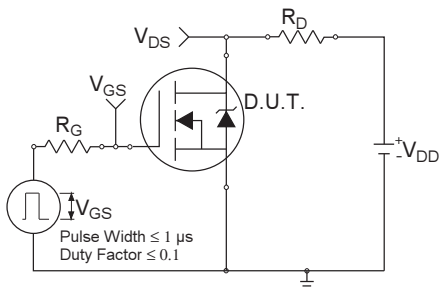
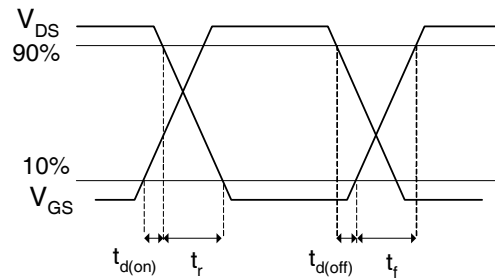
Fig 3. Typical Transfer Characteristics

Fig 4. Normalized On-Resistance vs. Temperature

Fig 5. Typical Capacitance vs. Drain-to-Source Voltage

Fig 6. Typical Gate Charge vs. Gate-to-Source Voltage

Fig 7. Typical Source-Drain Diode Forward Voltage

Fig 8. Maximum Safe Operating Area

Fig 9. Maximum Drain Current vs. Case (Bottom) Temperature

Fig 10. Threshold Voltage vs. Temperature

Fig 11. Maximum Effective Transient Thermal Impedance, Junction-to-Case (Bottom)

Fig 12. On-Resistance vs. Gate Voltage

Fig 13. Maximum Avalanche Energy vs. Drain Current

Fig 14a. Unclamped Inductive Test Circuit

Fig 14b. Unclamped Inductive Waveforms

Fig 15a. Switching Time Test Circuit

Fig 15b. Switching Time Waveforms

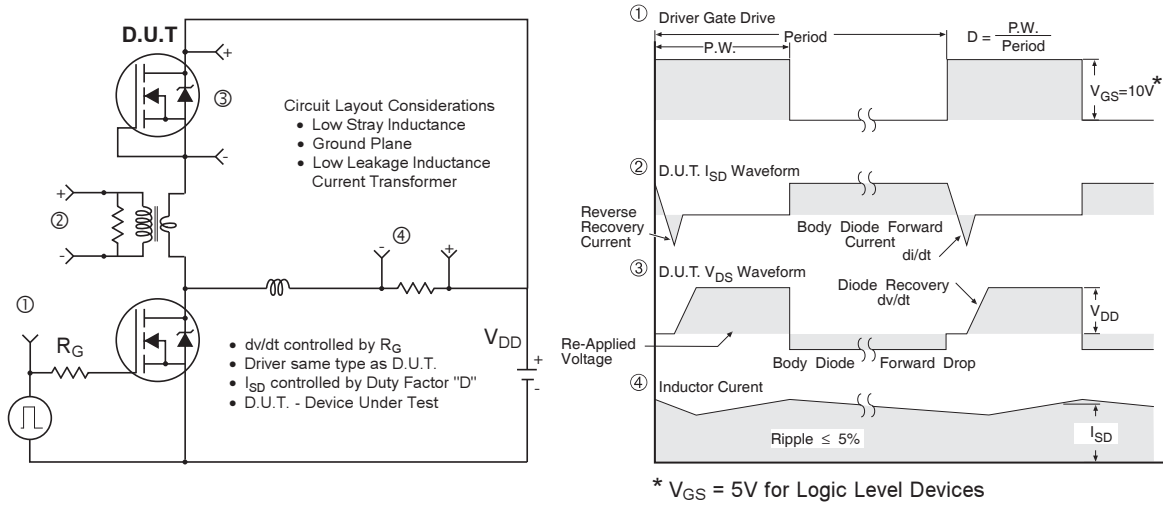

Fig 16. Peak Diode Recovery dv/dt Test Circuit for N-Channel HEXFET[®] Power MOSFETs

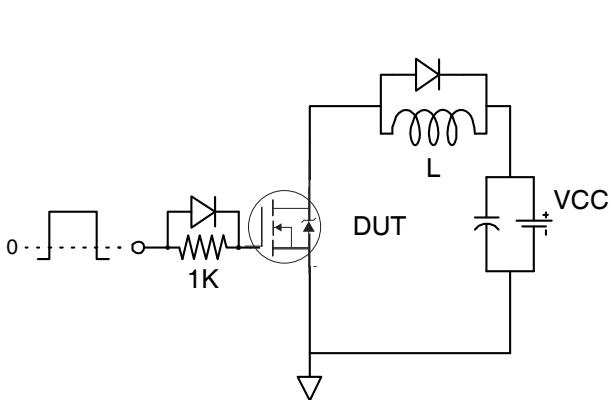

Fig 17. Gate Charge Test Circuit

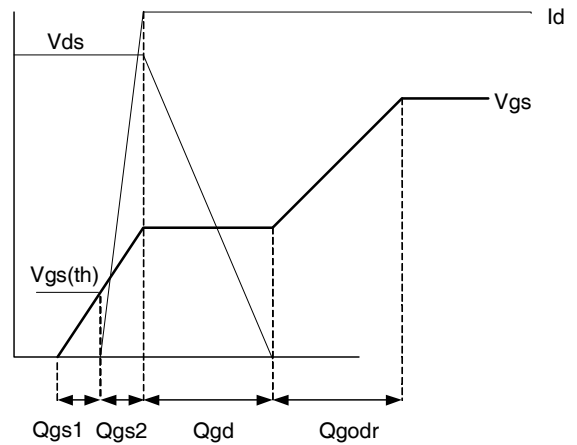
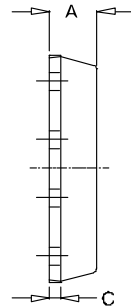
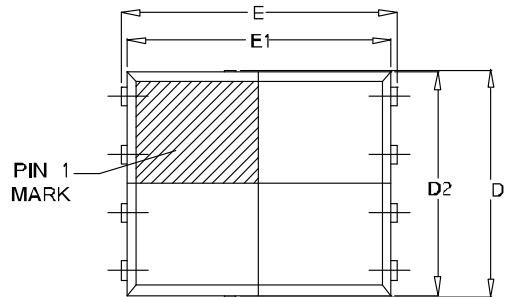

Fig 18. Gate Charge Waveform

PQFN 5x6 Outline "E" Package Details



SIDEVIEW



TOP VIEW

| SYMBOL | OUTLINE PQFN 5X6E | | |
|--------|-------------------|------|------|
| | MIN. | NOM. | MAX. |
| A | 0.90 | 1.03 | 1.17 |
| b | 0.33 | 0.41 | 0.48 |
| C | 0.20 | 0.25 | 0.35 |
| D | 4.80 | 4.98 | 5.15 |
| D1 | 3.91 | 4.11 | 4.31 |
| D2 | 4.80 | 4.90 | 5.00 |
| E | 5.90 | 6.02 | 6.15 |
| E1 | 5.65 | 5.75 | 5.85 |
| E2 | 1.10 | — | — |
| e | 1.27 BSC | | |
| L | 0.05 | 0.15 | 0.25 |
| L1 | 0.38 | 0.44 | 0.50 |
| L2 | 0.51 | 0.68 | 0.86 |
| H | 3.32 | 3.45 | 3.58 |
| I | — | — | 0.18 |

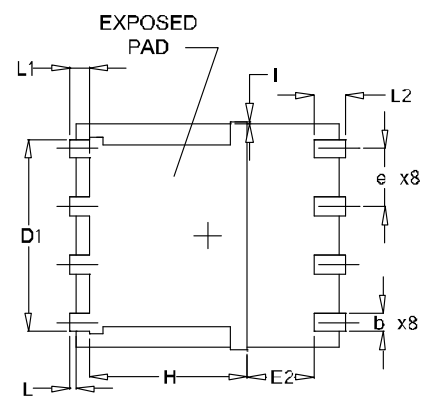

BOTTOM VIEW

For footprint and stencil design recommendations, please refer to application note AN-1154 at <http://www.irf.com/technical-info/appnotes/an-1154.pdf>

PQFN 5x6 Outline "E" Part Marking

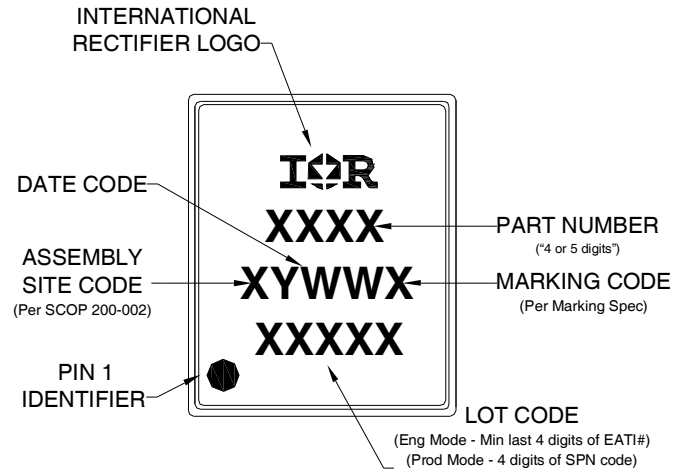

Note: For the most current drawing please refer to IR website at: <http://www.irf.com/package/>

PQFN 5x6 Outline "E" Tape and Reel

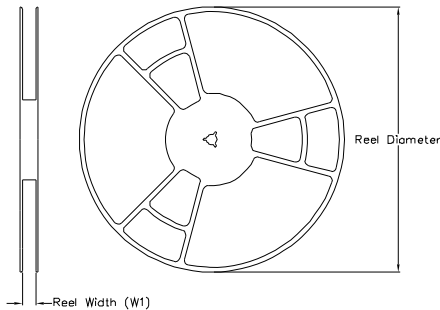
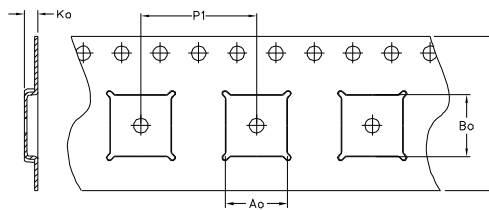
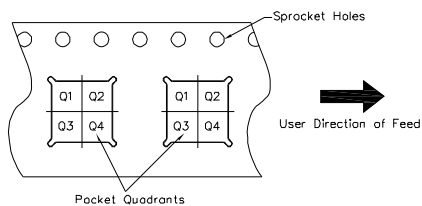
REEL DIMENSIONS

TAPE DIMENSIONS

QUADRANT ASSIGNMENTS FOR PIN 1 ORIENTATION IN TAPE

| CODE | DIMENSION (MM) | | DIMENSION (INCH) | |
|---------------|----------------|-------|------------------|------|
| | MIN | MAX | MIN | MAX |
| A_o | 6.20 | 6.40 | .244 | .252 |
| B_o | 5.20 | 5.40 | .205 | .213 |
| K_o | 1.10 | 1.30 | .043 | .051 |
| P_1 | 7.90 | 8.10 | .311 | .319 |
| W | 11.80 | 12.20 | .465 | .480 |
| W_1 | 12.30 | 12.50 | .484 | .492 |
| Qty | 4000 | | | |
| Reel Diameter | 13 Inches | | | |

| CODE | DESCRIPTION |
|-------|---|
| A_o | Dimension design to accommodate the component width |
| B_o | Dimension design to accommodate the component length |
| K_o | Dimension design to accommodate the component thickness |
| W | Overall width of the carrier tape |
| P_1 | Pitch between successive cavity centers |

Note: For the most current drawing please refer to IR website at: <http://www.irf.com/package/>

Qualification information[†]

| | | |
|----------------------------|--|--|
| Qualification level | Consumer ^{††} (per JEDEC JESD47F ^{†††} guidelines) | |
| Moisture Sensitivity Level | PQFN 5mm x 6mm | MSL1 (per JEDEC J-STD-020D ^{†††}) |
| RoHS compliant | Yes | |

† Qualification standards can be found at International Rectifier's web site

<http://www.irf.com/product-info/reliability>

†† Higher qualification ratings may be available should the user have such requirements.
Please contact your International Rectifier sales representative for further information:

<http://www.irf.com/whoto-call/salesrep/>

††† Applicable version of JEDEC standard at the time of product release.

Notes:

- ① Repetitive rating; pulse width limited by max. junction temperature.
- ② Starting $T_J = 25^\circ\text{C}$, $L = 0.78\text{mH}$, $R_G = 50\Omega$, $I_{AS} = 20\text{A}$.
- ③ Pulse width $\leq 400\mu\text{s}$; duty cycle $\leq 2\%$.
- ④ R_θ is measured at T_J of approximately 90°C .
- ⑤ When mounted on 1 inch square 2 oz copper pad on 1.5x1.5 in. board of FR-4 material.
- ⑥ Calculated continuous current based on maximum allowable junction temperature.
- ⑦ Current is limited to 50A by source bonding technology.

Revision History

| Date | Comment |
|-----------|--|
| 5/13/2014 | <ul style="list-style-type: none"> • Updated ordering information to reflect the End-Of-life (EOL) of the mini-reel option (EOL notice #259) • Updated Tape and Reel on page 8. • Updated data sheet based on corporate template. |