



MODEL: CMT-5023S-SMT | **DESCRIPTION:** MAGNETIC BUZZER TRANSDUCER

FEATURES

- 5 x 5 x 2 mm
- SMT
- rated frequency of 4000 Hz

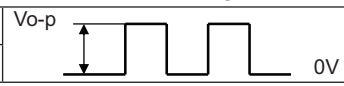

SPECIFICATIONS

parameter	conditions/description	min	typ	max	units
rated voltage			3.0		Vo-p
operating voltage		2.0		4.0	Vo-p
current consumption	at rated voltage, 4,000 Hz square wave, 1/2 duty			110	mA
rated frequency			4,000		Hz
sound pressure level	at 10 cm (A-weight), rated voltage, 4,000 Hz square wave, 1/2 duty	80			dBa
coil resistance		9	12	15	Ω
dimensions	5.0 x 5.0 x 2.0				mm
weight			0.35		g
material	LCP				
terminal	SMT type (Sn plating)				
operating temperature		-30		70	°C
storage temperature		-40		85	°C
RoHS	2011/65/EU				

Notes: 1. Add suffix "-TR" to the model for tape & reel packaging
 2. All specifications measured at 5~35°C, humidity at 45~85%, under 86~106 kPa pressure, unless otherwise noted.

SOLDERABILITY

parameter	conditions/description	min	typ	max	units
reflow soldering	see recommended reflow soldering profile			240	°C

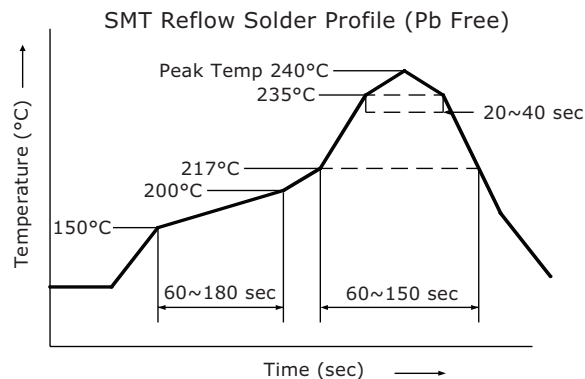

MECHANICAL DRAWING

units: mm
tolerance: ± 0.2 mm

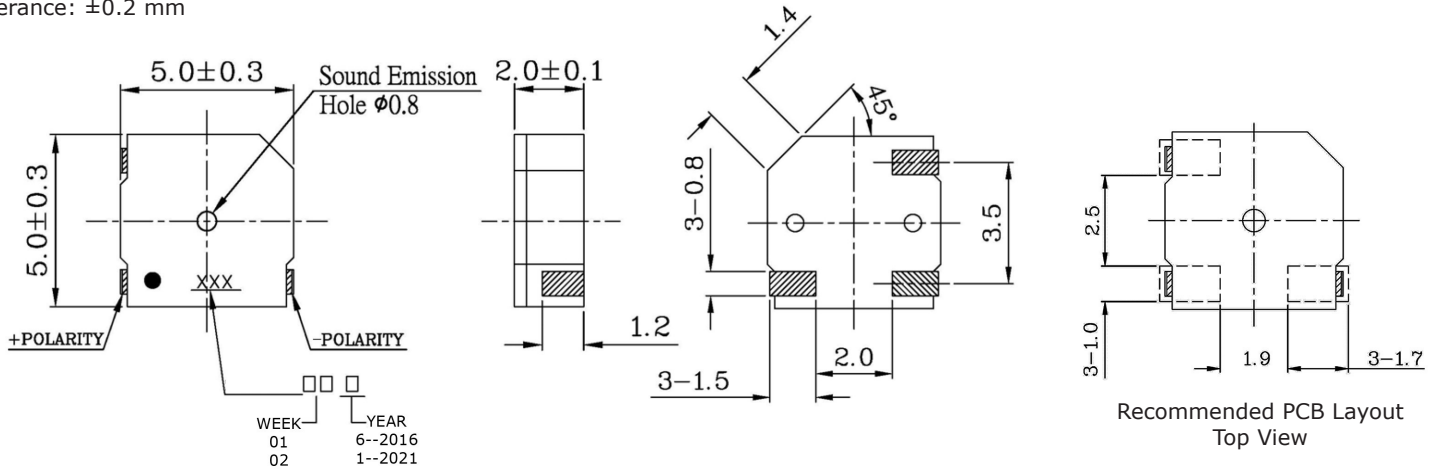

FREQUENCY RESPONSE CURVE

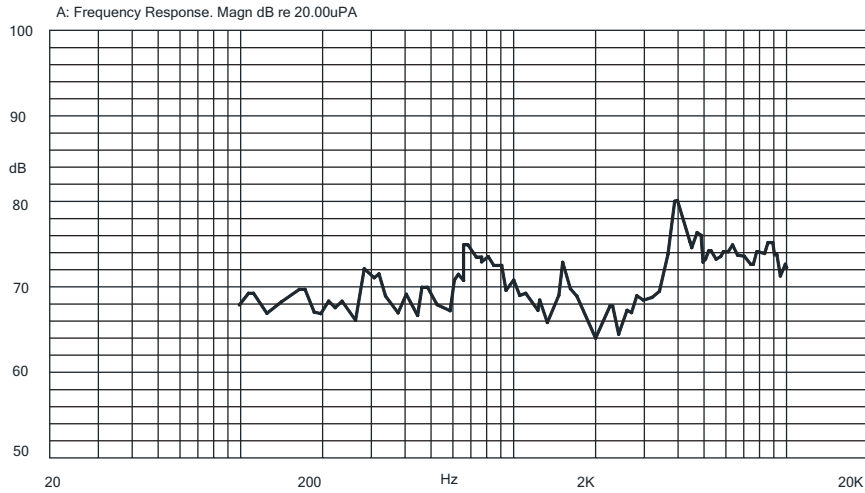

MEASUREMENT METHOD



PACKAGING

units: mm

Reel Size: $\varnothing 330$ mm
 Carton Size: 370 x 350 x 350 mm
 Reel QTY: 2,500 pcs per reel
 Carton QTY: 25,000 pcs per carton

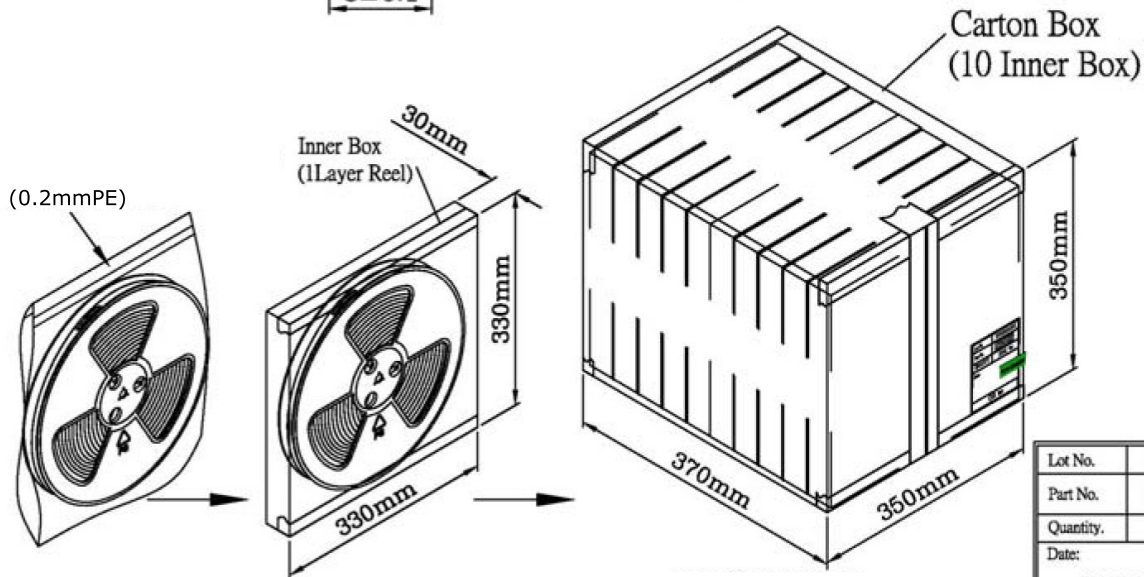
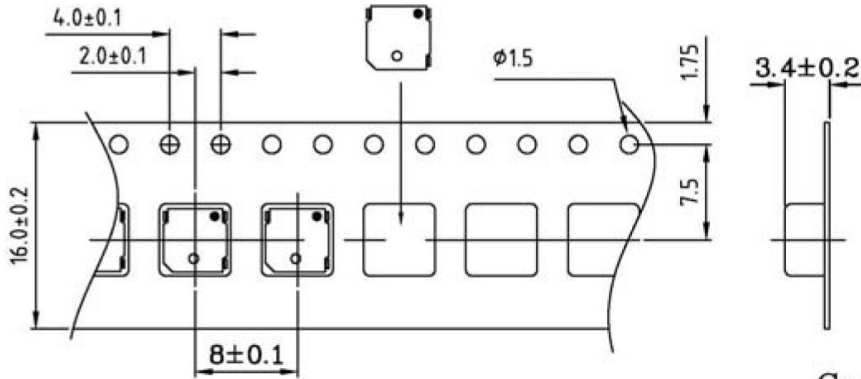
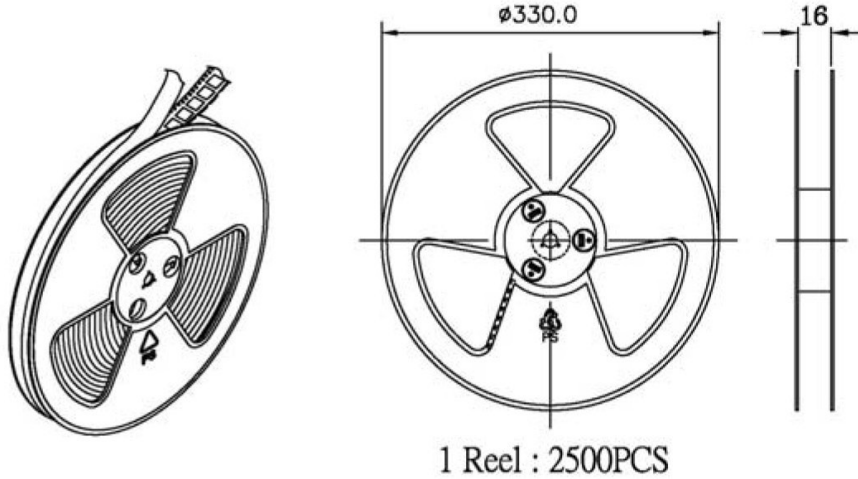

Lot No.	XXXXXXXXXX
Part No.	XXXXXXXXXX
Quantity.	XXXX Pcs
Date:	DD MM YY
RoHS Compliant	
CUI Inc	

REVISION HISTORY

rev.	description	date
1.0	initial release	03/28/2016

The revision history provided is for informational purposes only and is believed to be accurate.



CUI INC[®]

Headquarters
20050 SW 112th Ave.
Tualatin, OR 97062
800.275.4899

Fax 503.612.2383
cui.com
techsupport@cui.com

CUI offers a one (1) year limited warranty. Complete warranty information is listed on our website.

CUI reserves the right to make changes to the product at any time without notice. Information provided by CUI is believed to be accurate and reliable. However, no responsibility is assumed by CUI for its use, nor for any infringements of patents or other rights of third parties which may result from its use.

CUI products are not authorized or warranted for use as critical components in equipment that requires an extremely high level of reliability. A critical component is any component of a life support device or system whose failure to perform can be reasonably expected to cause the failure of the life support device or system, or to affect its safety or effectiveness.