

# C3225CH2A473J230AA

TDK Item Description : C3225CH2A473JT\*\*\*



## Application & Main Feature

Commercial Grade ( Mid Voltage (100 to 630V) )

## Series

C3225 [EIA CC1210]

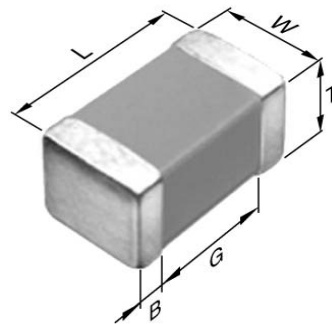

## Dimensions

L 3.20mm +/-0.4mm  
 W 2.50mm +/-0.3mm  
 T 2.30mm +/-0.2mm  
 B 0.20mm Min.  
 G

## Temperature Characteristic

CH (-25 to 85 degC 0+/-60ppm/degC)

## Rated Voltage

2A (100Vdc)

## Capacitance

47nF

## Capacitance Tolerance

J (+/-5%)

## Q Factor

1000 Min.

## Insulation Resistance

10Gohm Min.

## AEC-Q200

Not Applicable

**|Z|, ESR vs. Freq. Characteristics**

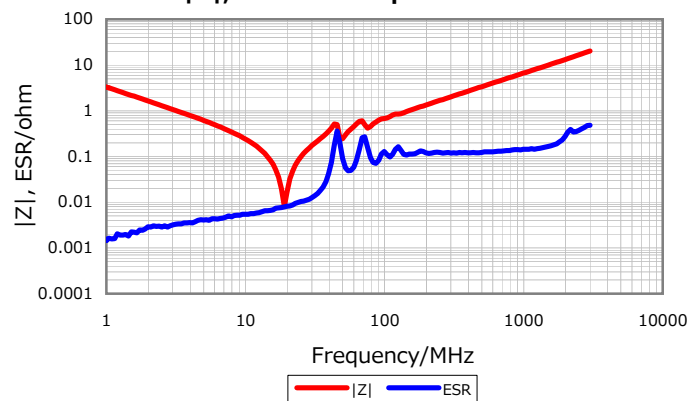

**DC Bias Characteristic**



**Cap. vs. Freq. Characteristic**

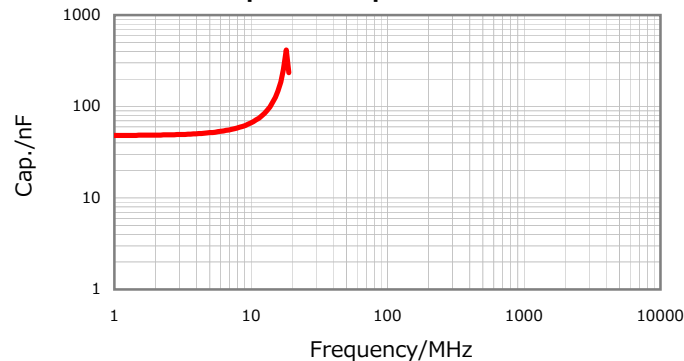

**Temperature Characteristics**



Characterization Sheet ( Multilayer Ceramic Chip Capacitors )



All specifications are subject to change without notice.

January 4, 2016