

## OptiMOS™3 Power-Transistor

### Features

- N-channel, normal level
- Excellent gate charge x  $R_{DS(on)}$  product (FOM)
- Very low on-resistance  $R_{DS(on)}$
- 175 °C operating temperature
- Pb-free lead plating; RoHS compliant
- Qualified according to JEDEC<sup>1)</sup> for target application
- Halogen-free according to IEC61249-2-21
- Ideal for high-frequency switching and synchronous rectification

### Product Summary

$V_{DS}$	250	V
$R_{DS(on),max}$	20	mΩ
$I_D$	64	A



Type	IPB200N25N3 G	IPP200N25N3 G	IPI200N25N3 G
Package	PG-TO263-3	PG-TO220-3	PG-TO262-3
Marking	200N25N	200N25N	200N25N

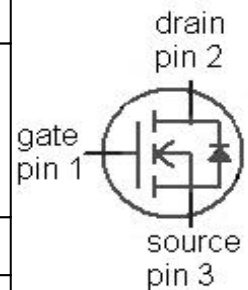

Maximum ratings, at  $T_j=25\text{ °C}$ , unless otherwise specified

Parameter	Symbol	Conditions	Value	Unit
Continuous drain current	$I_D$	$T_C=25\text{ °C}$	64	A
		$T_C=100\text{ °C}$	46	
Pulsed drain current <sup>2)</sup>	$I_{D,pulse}$	$T_C=25\text{ °C}$	256	
Avalanche energy, single pulse	$E_{AS}$	$I_D=47\text{ A}$ , $R_{GS}=25\text{ Ω}$	320	mJ
Reverse diode $dv/dt$	$dv/dt$		10	kV/μs
Gate source voltage	$V_{GS}$		±20	V
Power dissipation	$P_{tot}$	$T_C=25\text{ °C}$	300	W
Operating and storage temperature	$T_j$ , $T_{stg}$		-55 ... 175	°C
IEC climatic category; DIN IEC 68-1			55/175/56	

<sup>1)</sup>J-STD20 and JESD22

<sup>2)</sup> See figure 3

Parameter	Symbol	Conditions	Values			Unit
			min.	typ.	max.	

**Thermal characteristics**

Thermal resistance, junction - case	$R_{thJC}$		-	-	0.5	K/W
Thermal resistance, junction - ambient	$R_{thJA}$	minimal footprint	-	-	62	
		6 cm <sup>2</sup> cooling area <sup>3)</sup>	-	-	40	

**Electrical characteristics, at  $T_j=25\text{ °C}$ , unless otherwise specified**
**Static characteristics**

Drain-source breakdown voltage	$V_{(BR)DSS}$	$V_{GS}=0\text{ V}, I_D=1\text{ mA}$	250	-	-	V
Gate threshold voltage	$V_{GS(th)}$	$V_{DS}=V_{GS}, I_D=270\text{ }\mu\text{A}$	2	3	4	
Zero gate voltage drain current	$I_{DSS}$	$V_{DS}=200\text{ V}, V_{GS}=0\text{ V}, T_j=25\text{ °C}$	-	0.1	1	$\mu\text{A}$
		$V_{DS}=200\text{ V}, V_{GS}=0\text{ V}, T_j=125\text{ °C}$	-	10	100	
Gate-source leakage current	$I_{GSS}$	$V_{GS}=20\text{ V}, V_{DS}=0\text{ V}$	-	1	100	nA
Drain-source on-state resistance	$R_{DS(on)}$	$V_{GS}=10\text{ V}, I_D=64\text{ A}$	-	17.5	20	m $\Omega$
Gate resistance	$R_G$		-	2.4	-	$\Omega$
Transconductance	$g_{fs}$	$ V_{DS} >2 I_D R_{DS(on)max}, I_D=64\text{ A}$	61	122	-	S

<sup>3)</sup> Device on 40 mm x 40 mm x 1.5 mm epoxy PCB FR4 with 6 cm<sup>2</sup> (one layer, 70  $\mu\text{m}$  thick) copper area for drain connection. PCB is vertical in still air.

Parameter	Symbol	Conditions	Values			Unit
			min.	typ.	max.	

**Dynamic characteristics**

Input capacitance	$C_{iss}$	$V_{GS}=0\text{ V}, V_{DS}=100\text{ V},$ $f=1\text{ MHz}$	-	5340	7100	pF
Output capacitance	$C_{oss}$		-	297	395	
Reverse transfer capacitance	$C_{rss}$		-	4	-	
Turn-on delay time	$t_{d(on)}$	$V_{DD}=100\text{ V},$ $V_{GS}=10\text{ V}, I_D=25\text{ A},$ $R_G=1.6\ \Omega$	-	18	-	ns
Rise time	$t_r$		-	20	-	
Turn-off delay time	$t_{d(off)}$		-	45	-	
Fall time	$t_f$		-	12	-	

**Gate Charge Characteristics<sup>4)</sup>**

Gate to source charge	$Q_{gs}$	$V_{DD}=100\text{ V}, I_D=25\text{ A},$ $V_{GS}=0\text{ to }10\text{ V}$	-	22	-	nC
Gate to drain charge	$Q_{gd}$		-	7	-	
Switching charge	$Q_{sw}$		-	13	-	
Gate charge total	$Q_g$		-	64	86	
Gate plateau voltage	$V_{plateau}$		-	4.2	-	
Output charge	$Q_{oss}$	$V_{DD}=100\text{ V}, V_{GS}=0\text{ V}$	-	135	179	nC

**Reverse Diode**

Diode continuous forward current	$I_S$	$T_C=25\text{ °C}$	-	-	64	A
Diode pulse current	$I_{S,pulse}$		-	-	256	
Diode forward voltage	$V_{SD}$	$V_{GS}=0\text{ V}, I_F=64\text{ A},$ $T_j=25\text{ °C}$	-	1	1.2	V
Reverse recovery time	$t_{rr}$	$V_R=100\text{ V}, I_F=25\text{ A},$ $di_F/dt=100\text{ A}/\mu\text{s}$	-	170	-	ns
Reverse recovery charge	$Q_{rr}$		-	780	-	nC

<sup>4)</sup> See figure 16 for gate charge parameter definition

### 1 Power dissipation

$$P_{tot}=f(T_C)$$

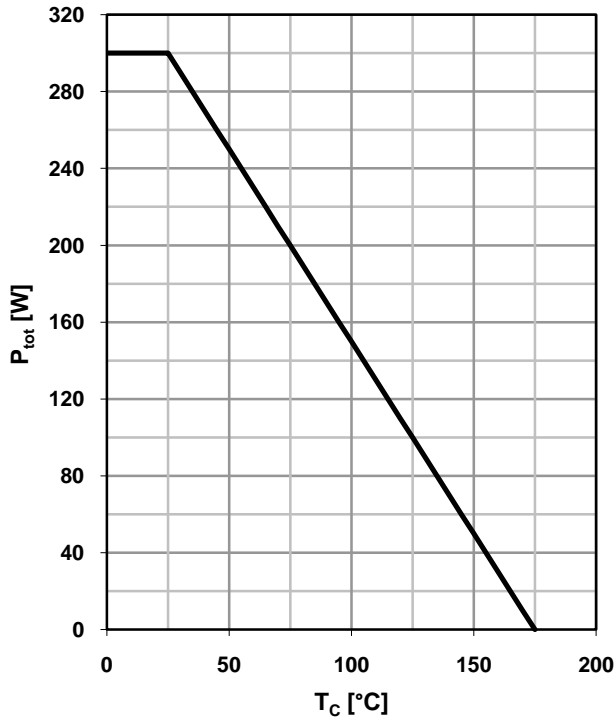

### 2 Drain current

$$I_D=f(T_C); V_{GS} \geq 10 \text{ V}$$

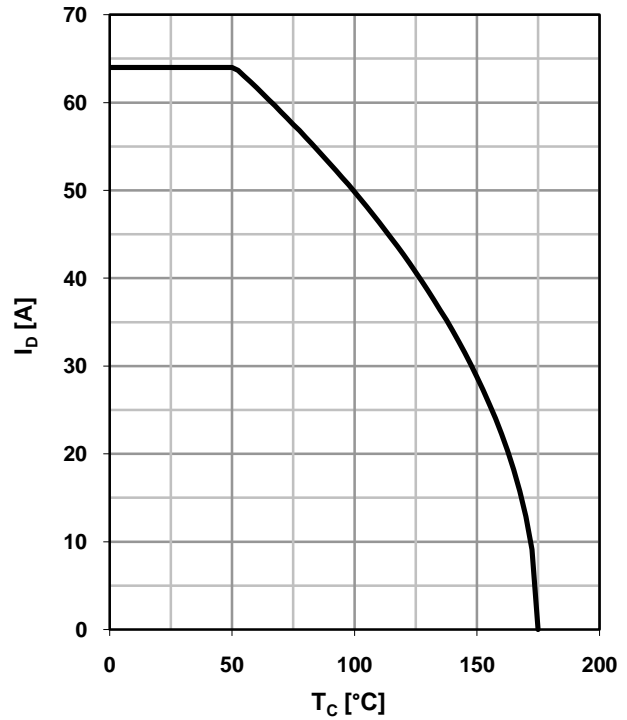

### 3 Safe operating area

$$I_D=f(V_{DS}); T_C=25 \text{ °C}; D=0$$

parameter:  $t_p$

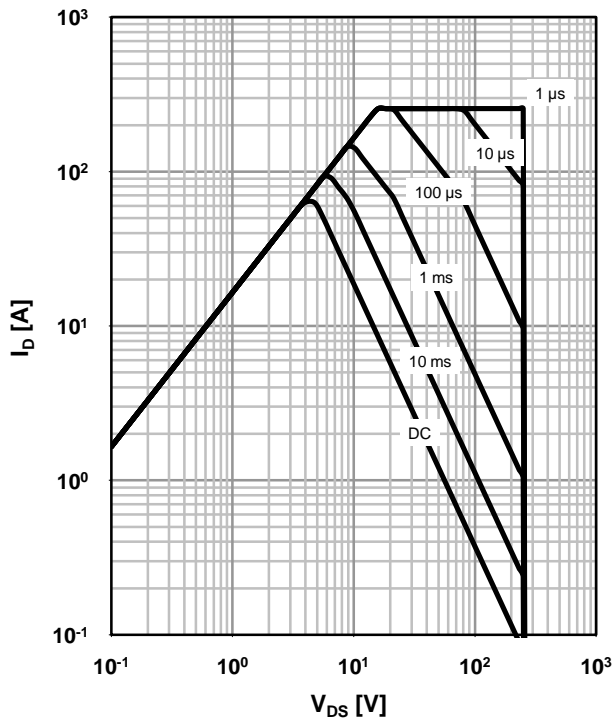

### 4 Max. transient thermal impedance

$$Z_{thJC}=f(t_p)$$

parameter:  $D=t_p/T$

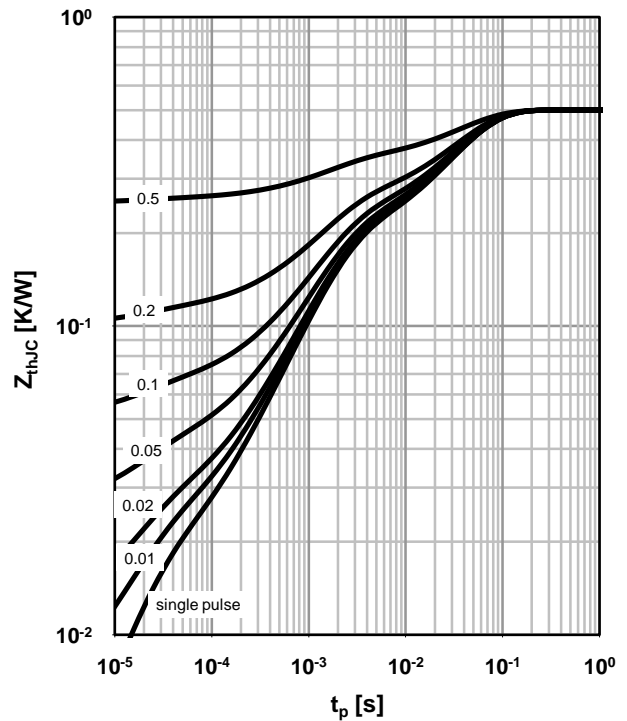

**5 Typ. output characteristics**

$I_D = f(V_{DS}); T_j = 25\text{ °C}$

parameter:  $V_{GS}$

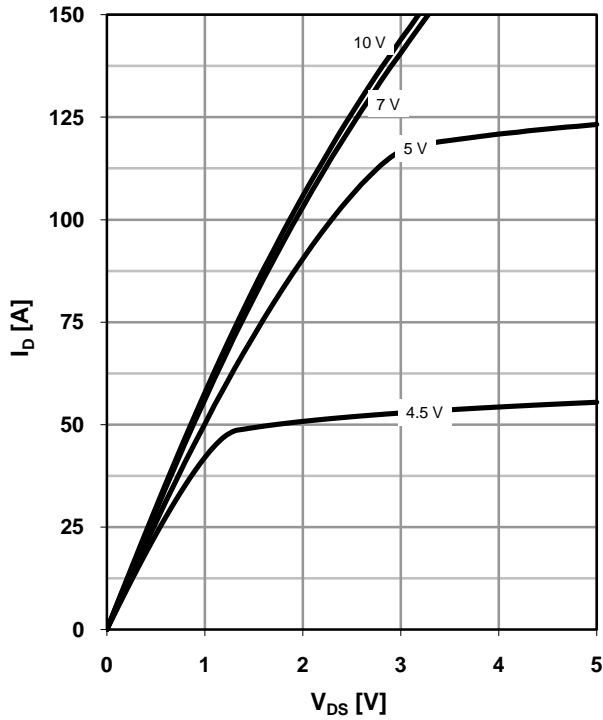

**6 Typ. drain-source on resistance**

$R_{DS(on)} = f(I_D); T_j = 25\text{ °C}$

parameter:  $V_{GS}$

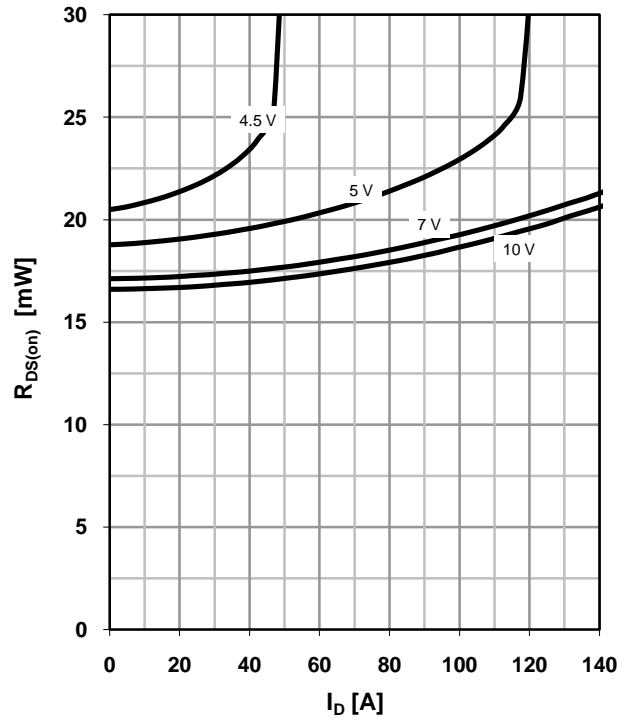

**7 Typ. transfer characteristics**

$I_D = f(V_{GS}); |V_{DS}| > 2|I_D|R_{DS(on)max}$

parameter:  $T_j$

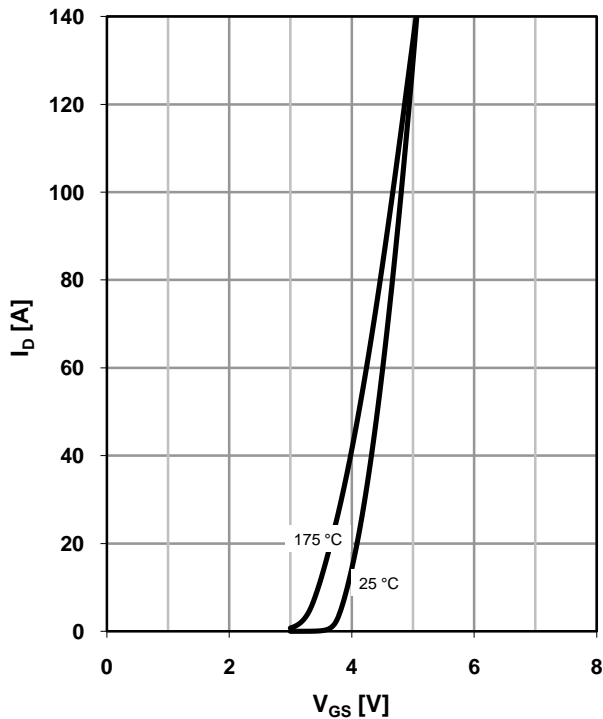

**8 Typ. forward transconductance**

$g_{fs} = f(I_D); T_j = 25\text{ °C}$

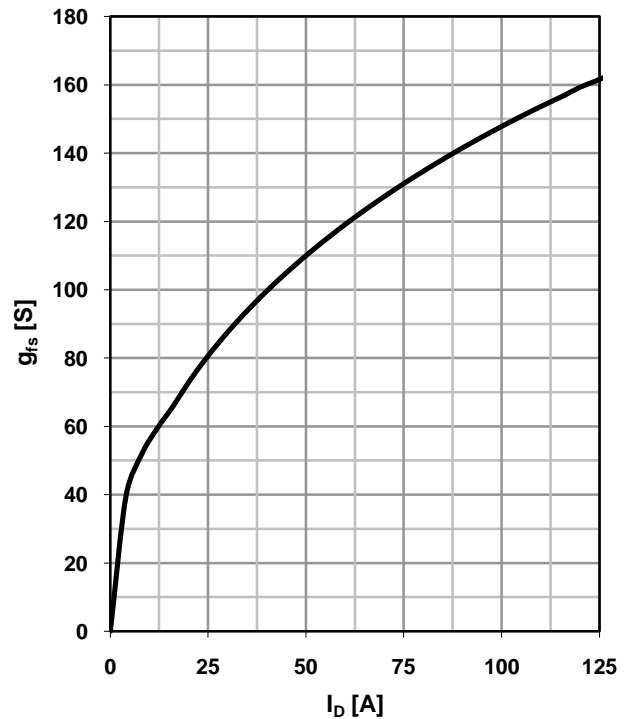

**9 Drain-source on-state resistance**

$R_{DS(on)}=f(T_j); I_D=64\text{ A}; V_{GS}=10\text{ V}$

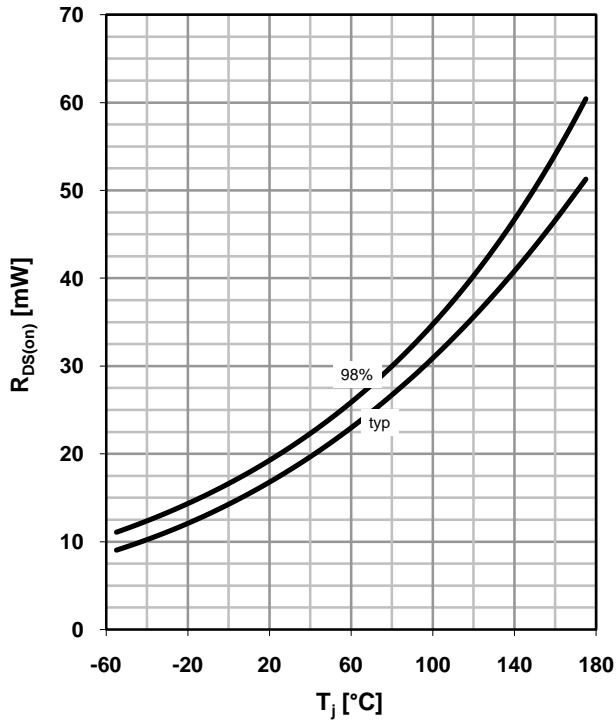

**10 Typ. gate threshold voltage**

$V_{GS(th)}=f(T_j); V_{GS}=V_{DS}$

parameter:  $I_D$

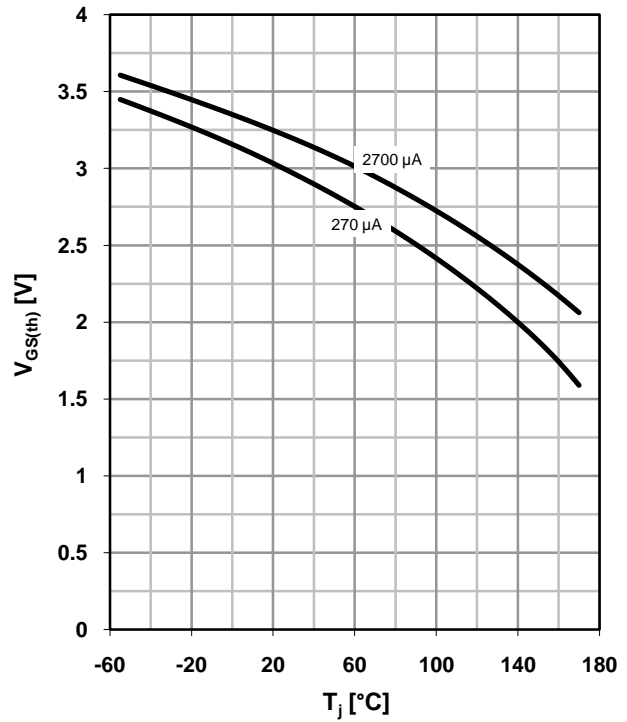

**11 Typ. capacitances**

$C=f(V_{DS}); V_{GS}=0\text{ V}; f=1\text{ MHz}$

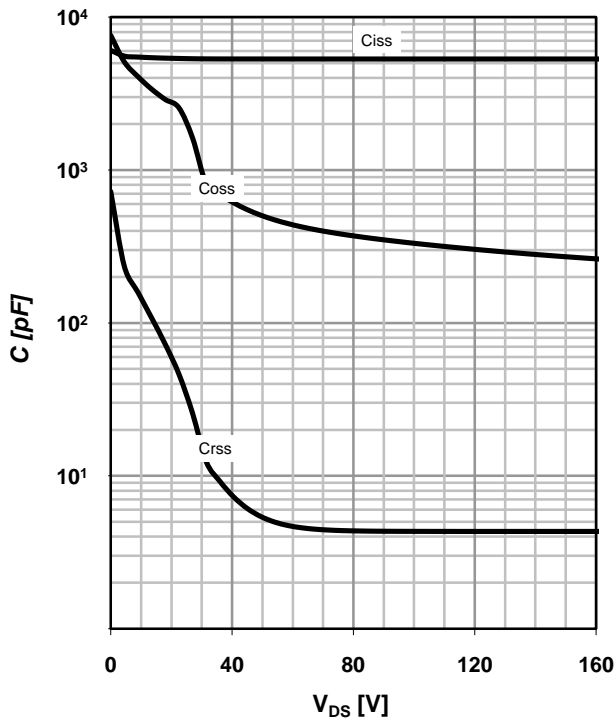

**12 Forward characteristics of reverse diode**

$I_F=f(V_{SD})$

parameter:  $T_j$

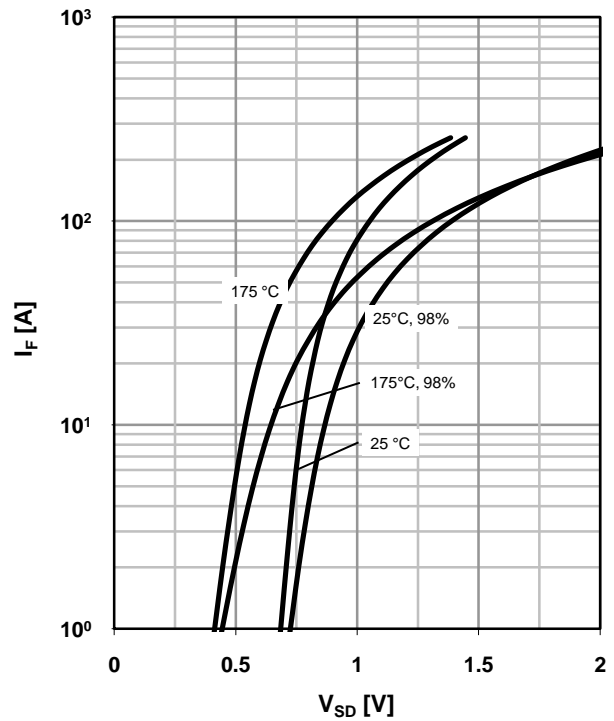

### 13 Avalanche characteristics

$$I_{AS} = f(t_{AV}); R_{GS} = 25 \Omega$$

parameter:  $T_{j(\text{start})}$

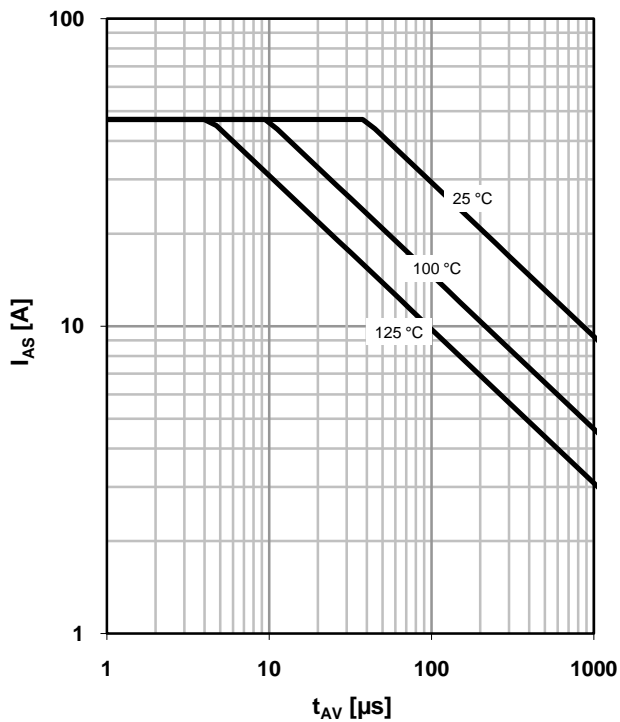

### 14 Typ. gate charge

$$V_{GS} = f(Q_{\text{gate}}); I_D = 25 \text{ A pulsed}$$

parameter:  $V_{DD}$

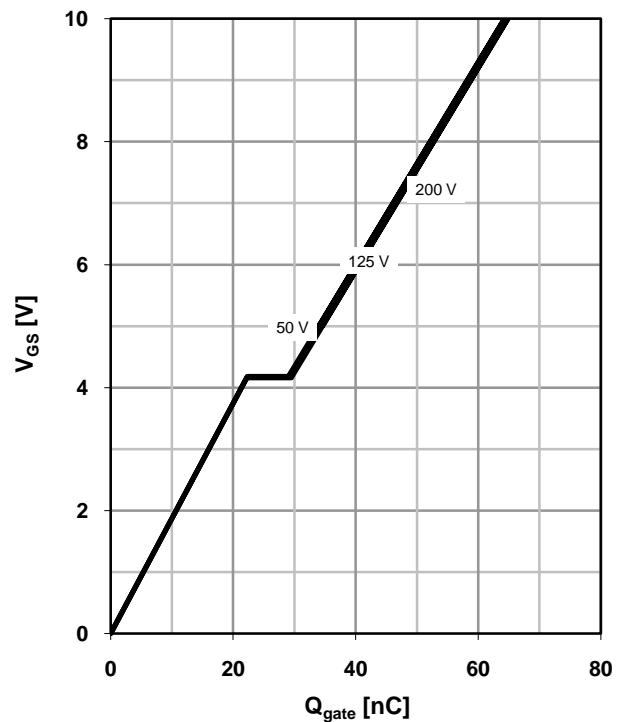

### 15 Drain-source breakdown voltage

$$V_{BR(DSS)} = f(T_j); I_D = 1 \text{ mA}$$

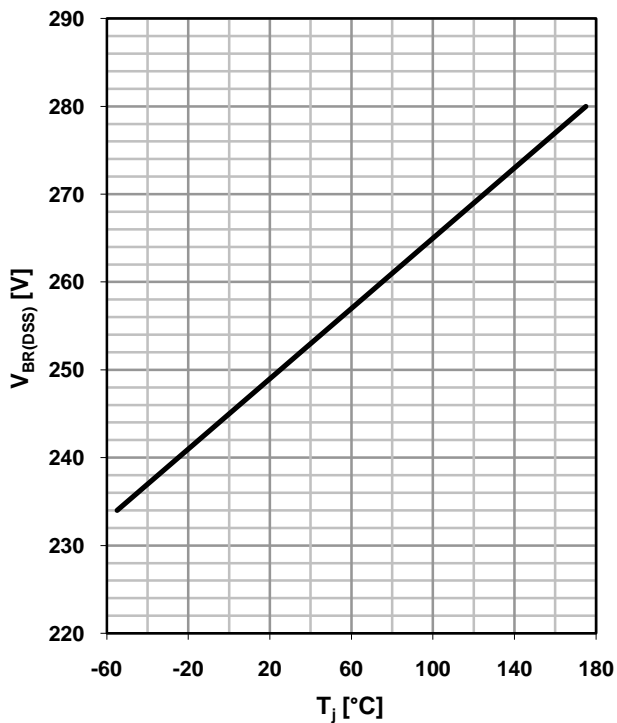

### 16 Gate charge waveforms







PG-TO263-3: Outline

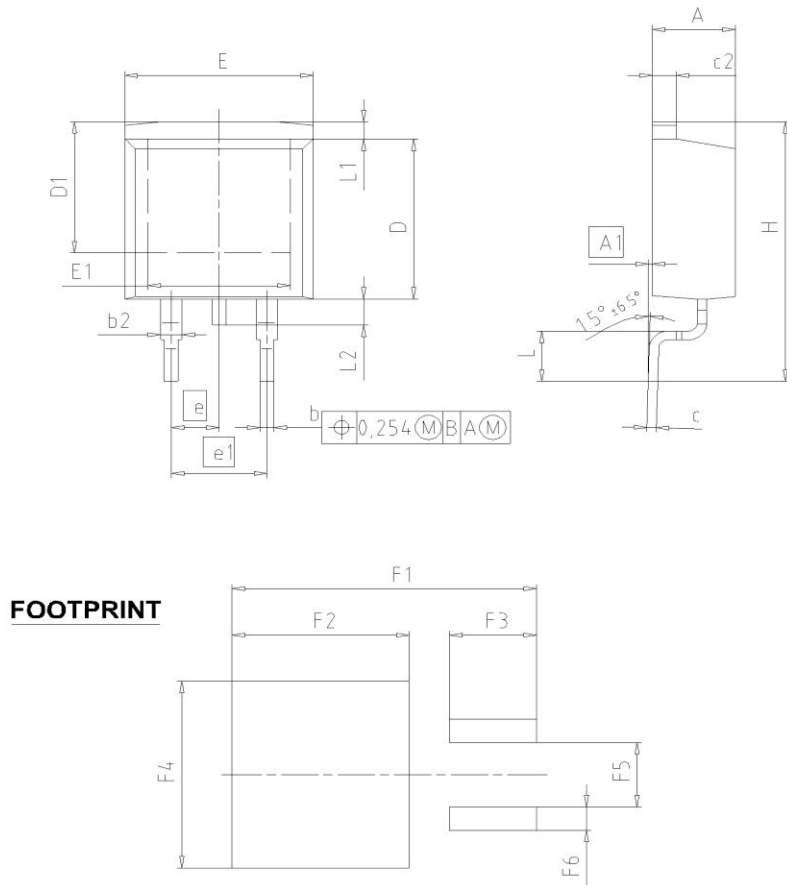

DIM	MILLIMETERS		INCHES	
	MIN	MAX	MIN	MAX
A	4.30	4.57	0.169	0.180
A1	0.00	0.25	0.000	0.010
b	0.65	0.85	0.026	0.033
b2	0.95	1.15	0.037	0.045
c	0.33	0.65	0.013	0.026
c2	1.17	1.40	0.046	0.055
D	8.51	9.45	0.335	0.372
D1	7.10	7.90	0.280	0.311
E	9.80	10.31	0.386	0.406
E1	6.50	8.60	0.256	0.339
e	2.54		0.100	
e1	5.08		0.200	
N	2		2	
H	14.61	15.88	0.575	0.625
L	2.29	3.00	0.090	0.118
L1	0.70	1.60	0.028	0.063
L2	1.00	1.78	0.039	0.070
F1	16.05	16.25	0.632	0.640
F2	9.30	9.50	0.366	0.374
F3	4.50	4.70	0.177	0.185
F4	10.70	10.90	0.421	0.429
F5	3.65	3.85	0.144	0.152
F6	1.25	1.45	0.049	0.057

**DOCUMENT NO.**  
Z8B00003324

**SCALE**

**EUROPEAN PROJECTION**

**ISSUE DATE**  
30-08-2007

**REVISION**  
01

PG-TO262-3: Outline

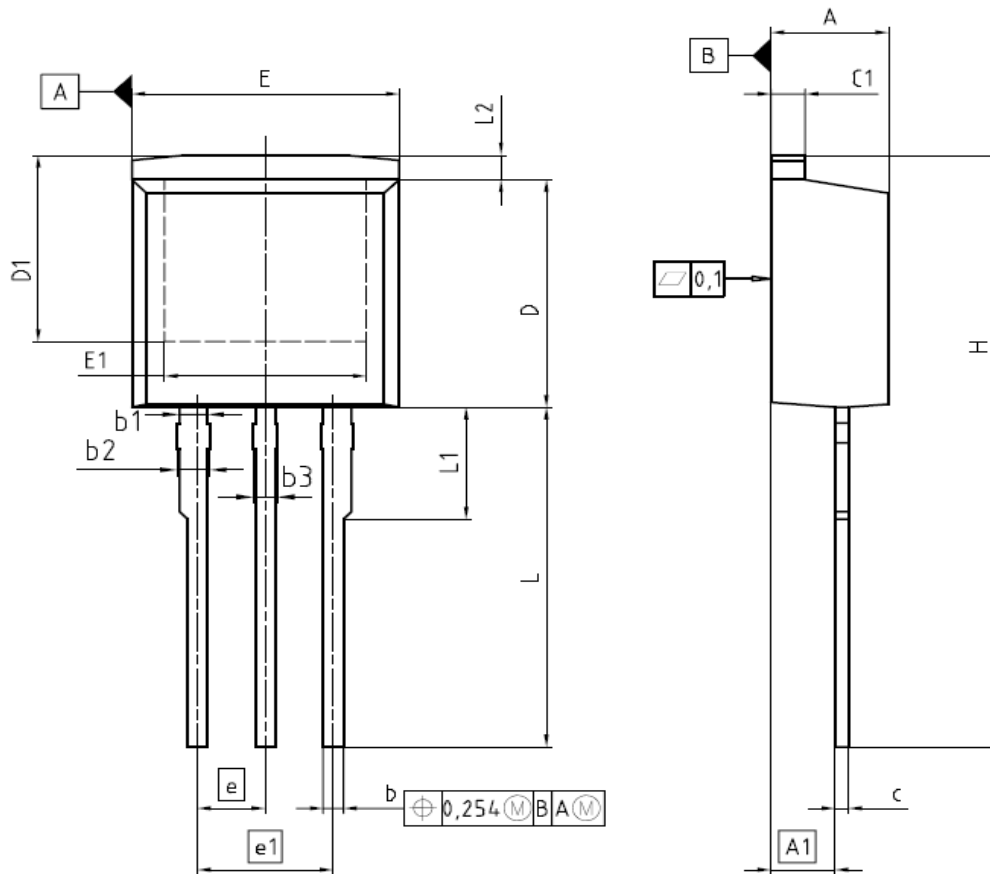

DIM	MILLIMETERS		INCHES	
	MIN	MAX	MIN	MAX
A	4.300	4.572	0.169	0.180
A1	2.150	2.718	0.085	0.107
b	0.650	0.864	0.026	0.034
b1	0.950	1.093	0.037	0.043
b2	0.950	1.400	0.037	0.055
b3	0.650	1.118	0.026	0.044
c	0.330	0.600	0.013	0.024
c1	1.170	1.400	0.046	0.055
D	8.509	9.450	0.335	0.372
D1	6.900	-	0.272	-
E	9.700	10.363	0.382	0.408
E1	6.500	8,600	0.256	0,339
e	2.540		0.100	
e1	5,080		0,200	
N	3		3	
L	13,000	14,000	0.512	0.551
L1	-	4.800	-	0.189
L2	-	1.727	-	0.068

REFERENCE  
Z8B00003325

SCALE

EUROPEAN PROJECTION

ISSUE DATE  
05-05-2006

REVISION  
03

**Published by**  
**Infineon Technologies AG**  
**81726 Munich, Germany**  
**© 2009 Infineon Technologies AG**  
**All Rights Reserved.**

**Legal Disclaimer**

The information given in this document shall in no event be regarded as a guarantee of conditions or characteristics. With respect to any examples or hints given herein, any typical values stated herein and/or any information regarding the application of the device, Infineon Technologies hereby disclaims any and all warranties and liabilities of any kind, including without limitation, warranties of non-infringement of intellectual property rights of any third party.

**Information**

For further information on technology, delivery terms and conditions and prices, please contact the nearest Infineon Technologies Office ([www.infineon.com](http://www.infineon.com)).

on the types in question, please contact the nearest Infineon Technologies Office.  
Infineon Technologies components may be used in life-support devices or systems only with the express written approval of Infineon Technologies, if a failure of such components can reasonably be expected to cause the failure of that life-support device or system or to affect the safety or effectiveness of that device or system. Life support devices or systems are intended to be implanted in the human body or to support and/or maintain and sustain and/or protect human life. If they fail, it is reasonable to assume that the health of the user or other persons may be endangered.