

400 Series, TE5®, Time-Lag Fuse

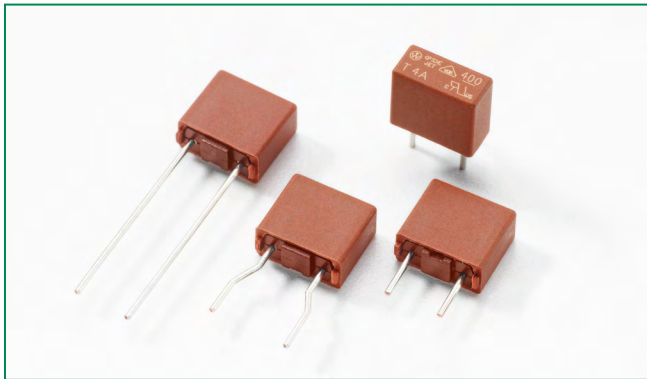

Description

The 400 Series is a TE5®, Time-Lag type subminiature fuse designed for overcurrent protection. It is 250V rated and designed in accordance to IEC 60127-3.

Features

- Lead-free and RoHS Compliant
- Reduced PCB space requirements
- Direct solderable or plug-in versions
- Low internal resistance
- Shock safe casing
- Vibration resistant
- Halogen-free

Applications

- Battery chargers
- Consumer electronics
- Power supplies
- Industrial controllers

Additional Information



Datasheet



Resources







Samples





Electrical Characteristics

% of Ampere Rating	Opening Time
150%	1 Hour, Minimum
210%	120 Secs., Maximum
275%	400 ms, Minimum; 10 Secs., Maximum
400%	150 ms, Minimum; 3 Secs., Maximum
1000%	20 ms, Minimum; 150 ms, Maximum

Agency Approvals

Agency	Agency File Number	Ampere Range
	E67006	800mA – 6.3A
	JET1896-31007-2001 JET1896-31007-1003	1A – 5A 6.3A
	DE1-40597	500mA – 6.3A
	CQC09012031624	500mA – 6.3A
	SUS05024-9004	500mA – 800mA
	SUS05024-9003	1A – 2.5A
	SUS05024-9001	3.15A
	SUS05024-10003	4A – 5A
	SUS05024-9002	6.3A

Electrical Characteristics

Amp Code	Rated Current	Rated Voltage	Breaking Capacity	Voltage Drop 1.0×I _N max. (mV)	Power Dissipation 1.0×I _N max. (mW)	Melting Integral 10×I _N max. (A ² s)	Agency Approvals				
											
0500	500mA	250V	130A/250VAC* 50-60 Hz cosφ = 1.0	165	297	2.17	x		x	x	x
0800	800mA	250V		116	387	6.72	x		x	x	x
1100	1.00A	250V		89	432	9.63	x	x	x	x	x
1125	1.25A	250V		76	411	14.44	x	x	x	x	x
1160	1.60A	250V		76	601	21.75	x	x	x	x	x
1200	2.00A	250V		75	758	32.16	x	x	x	x	x
1250	2.50A	250V		61	683	61.94	x	x	x	x	x
1315	3.15A	250V		55	921	101.61	x	x	x	x	x
1400	4.00A	250V		65	936	133.40	x	x	x	x	x
1500	5.00A	250V		56	948	216.50	x	x	x	x	x
1630	6.30A	250V		48	926	318.71	x	x	x	x	x

* Per VDE, approved breaking capacity is at 100A, 250VAC

Temperature Derating Curve

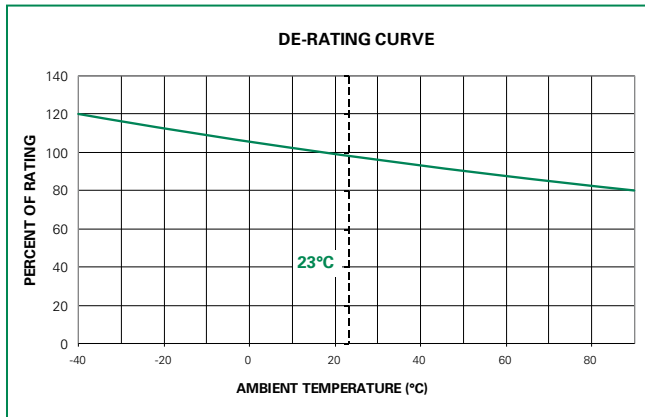

Average Time Current Curves

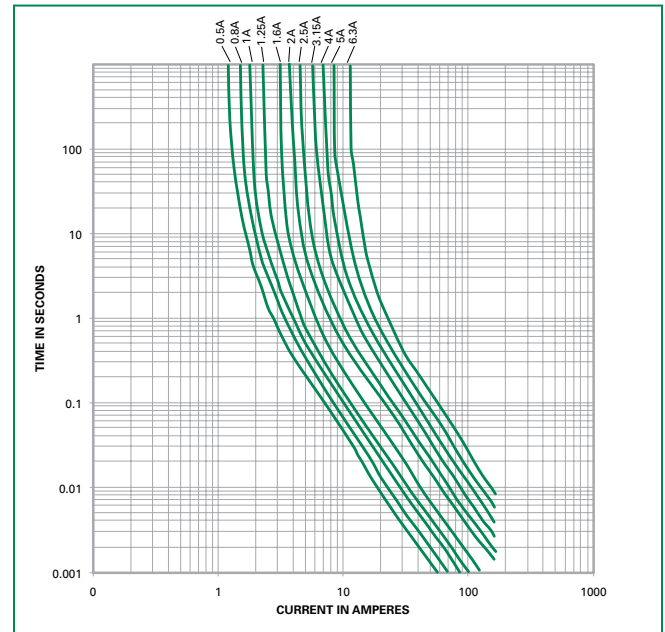

Soldering Parameters - Wave Soldering

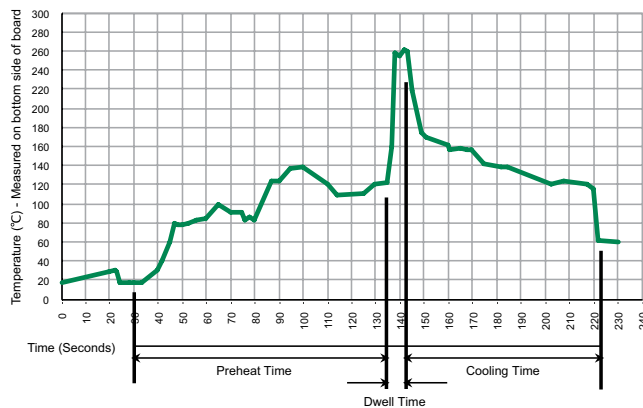

Recommended Process Parameters:

Wave Parameter	Lead-Free Recommendation
Preheat: (Depends on Flux Activation Temperature)	(Typical Industry Recommendation)
Temperature Minimum:	100° C
Temperature Maximum:	150° C
Preheat Time:	60-180 seconds
Solder Pot Temperature:	260° C Maximum
Solder Dwell Time:	2-5 seconds

Recommended Hand-Solder Parameters:

Solder Iron Temperature: 350° C +/- 5° C
Heating Time: 5 seconds max.

Note: These devices are not recommended for IR or Convection Reflow process.

Product Characteristics

Materials	Base/Cap: Brown Thermoplastic Polyamide, UL 94 V-0 Round Pins: Copper, Tin-plated
Lead Pull Strength	10 N (IEC 60068-2-21)
Solderability	260°C, ≤ 3s. (Wave) 350°C, ≤ 1s. (Soldering Iron)
Soldering Heat Resistance	260°C, 10s. (IEC 60068-2-20) 350°C, 3s. (Soldering Iron)

Operating Temperature	-40°C to +85°C (consider derating)
Climatic Category	-40°C to +85°C/21 days (EN 60068-1, -2-1, -2-2, -2-78)
Stock Conditions	+10°C to +60°C relative humidity 75% yearly average, without dew, maximum value for 30 days - 95%
Vibration Resistance	24 cycles at 15 min. each (EN60028-2-6) 10-60 Hz at 0.75 mm amplitude 20-2000 Hz at 10 g acceleration

Dimensions

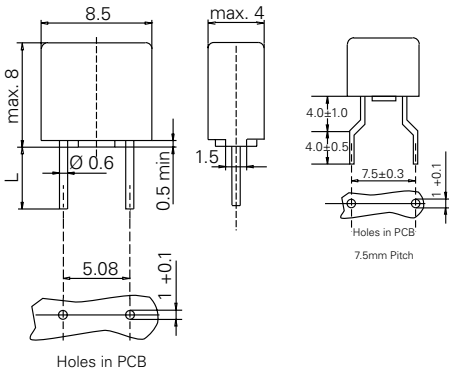

Long Leads (L=18.8±0.3mm)
Short Leads (L=4.3±0.3mm)

Part Numbering System

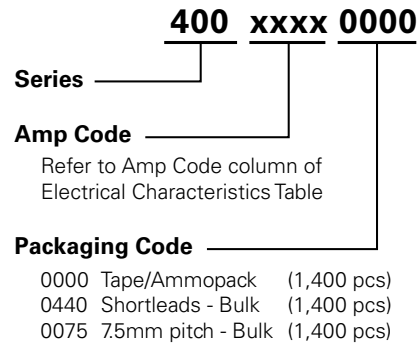

Packaging

Packaging Option	Packaging Specification	Quantity	Quantity & Packaging Code	Taping Width
400 Series				
Tape & Ammopack	N/A	1,400	0000	N/A
Short Leads	N/A	1,400	0440	N/A
7.5 mm Pitch	N/A	1,400	0075	N/A